

ULTRA-DEX

THE ULTIMATE INDEXABLE
METALWORKING SOURCE

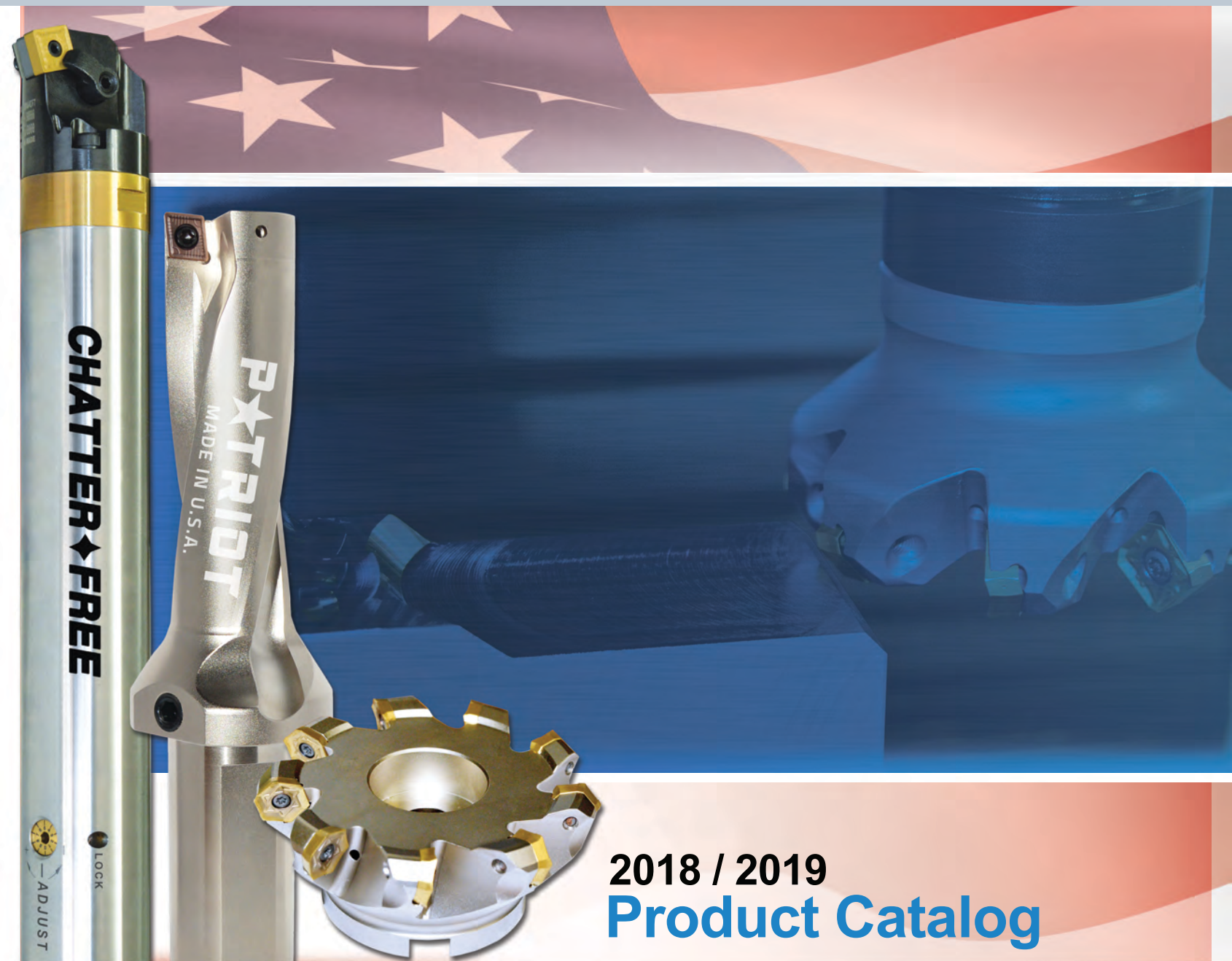

2018 / 2019
Product Catalog

ARCHTM

AMERICAN MANUFACTURING, SERVING THE WORLD

INTRODUCTION / DIRECTORY

Celebrating 28+ Years in the Tooling Industry!



Bringing You High Quality, Low Cost, American Made Tooling since 1988

Ultra-Dex prides itself on delivering the highest quality and the best value products to our customers. Continuing to prove American manufacturers can compete with imported products, through experienced personnel, using the latest technology and machining processes. As many of our satisfied customers have come to know, our passion is providing excellent products proudly made in the USA, at a great price.

For any questions

Email: sales@ultrausa.com

Repairs: repairs@ultra-dex.com

ultradexusa.com

Specials: sales@archglobalprecision.com

ARCHSpecials.com

For more information see pg 190

*To see additional product offerings go to **ARCHCuttingTools.com***

A **TURNING** *pgs 6-20*

Square Shank Indexable Tools

B **BORING** *pgs 22-106*

NOMENCLATURE p21

STEEL p23

Boring Bar Kits p42

Reduced Neck p43

Series Style Bars

p26, p28, p45, p46

CARBIDE p46

Metric p47

Solid Small Boring p65

Services / Coolant Adapters p66

Series Style Bars p51

p52, p58, p64

HEAVY METAL p67**MODULAR** p71

Bars p72

Heads p74

PULLBACK p82

CHATTER-FREE p85

Standard Bars p87

Solid Bars p89

Standard "CFT Style" Bars p90

Standard Heads p92

Serrated "CFT Style" Bars p99

Serrated Bars p100

Serrated Heads p102

C **MILLING** *pgs 107-120*

Indexable Milling Cutters

PATRIOT Mills p107**End Mills** p111**Face Mills** p113**Round Mills** p114**PATRIOT Counterbores** p115**Chamfer Mills** p118**ISO Mills** p119**D** **DRILLING** *pgs 121-130*

Indexable Drills

PATRIOT Drills p121**2.5xD Drills** p125**2xD Drills** p126**4xD Drills** p127**CUSTOM Order Drills** p129**E** **TOOL HOLDING** *pgs 131-166***CAT40** p132**CAT50** p138**HSK40A, 50A, 63A** p147**HSK 80A, 100A, 125A** p152**STRAIGHT SHANK** p161**CAT Retention Knobs** p144**HSK Coolant Tubes** p157**Tool Bushings** p159**Shrink-Fit Extensions** p158**ER Collets** p163**F** **INSERTS** *pgs 167-185***G** **HARDWARE +** *pgs 186-191***Hardware** p186**Services Including Repairs** p188**Ordering and Shipping** p190

SQUARE Shank Turning Tools

A**TURNING**

SQUARE SHANK TURNING TOOLS

.625" - 1.50" Shank Sizes

Insert Quick Pick

CNMG	Pg 8,10-12
DNMG	Pg 8,13
RNMG	Pg 14
SNMG	Pg 14-16
TNMG	Pg 16-18
VNMG	Pg 9,19
WNMG	Pg 9,20



Turning Tool NOMENCLATURE

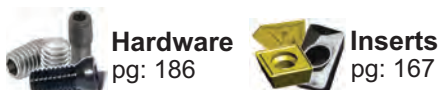
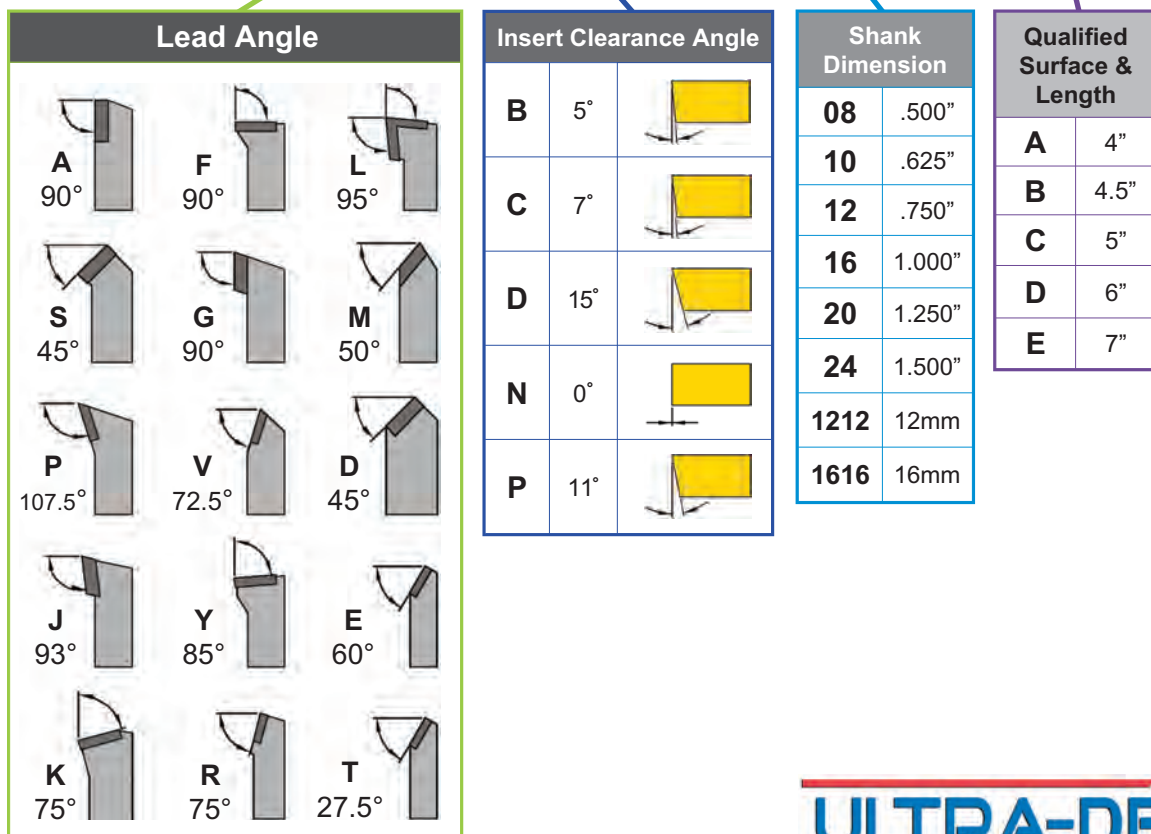
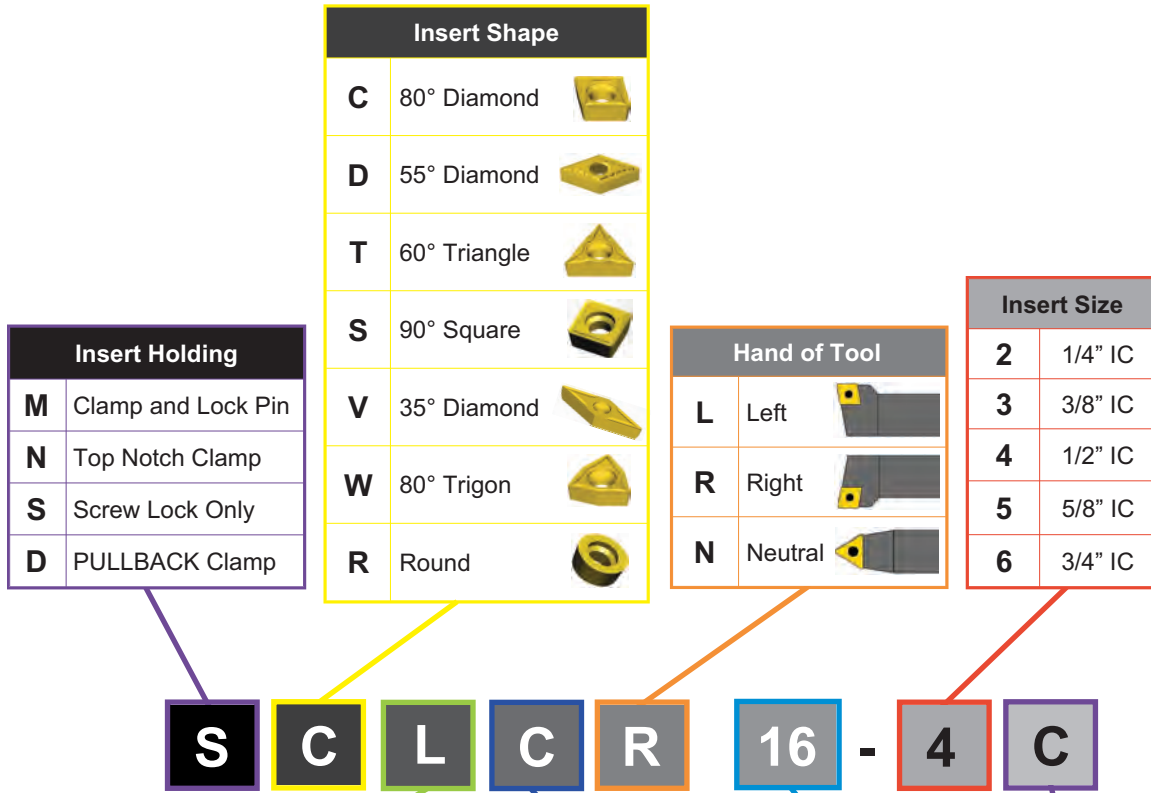

Proudly Made in Flushing, MI USA



SQUARE Shank Undercut & Profiling

A
TURNING

UNDERCUT & PROFILING SQUARE SHANK

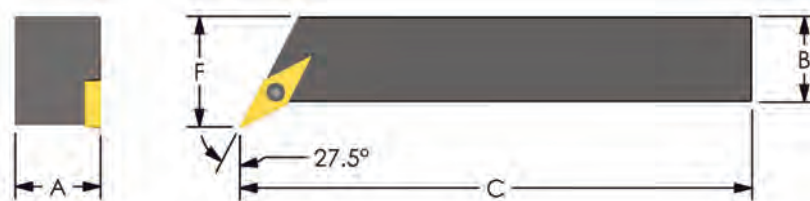
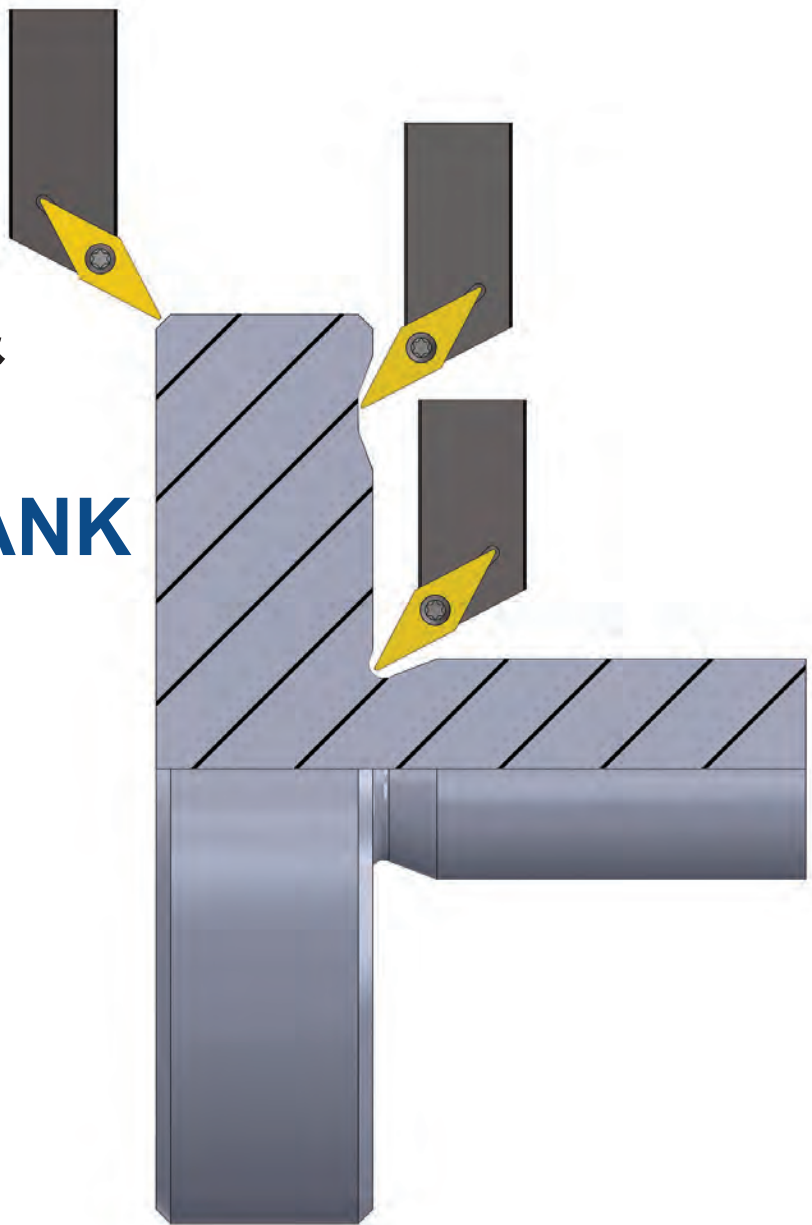

Positive 35° Diamond (-27.5° Lead)

No Coolant

Designation	A/B	C	F	Insert	Screw	Price
SVTBR/L 12-2B	.750	4.5	.935	VBMT 21.51	MTS-2.5L	\$60.00
SVTBR/L 12-3B	.750	4.5	1.050	VBMT 331	MTS-3.5L	\$60.00
SVTBR/L 16-3D	1.00	6	1.300		MTS-3.5L	\$66.00



SQUARE Shank Swiss Style

Swiss Style Square Shank

- Proper Insert Alignment for Swiss Processes
- Accepts standard ISO Inserts
- Specials available upon request

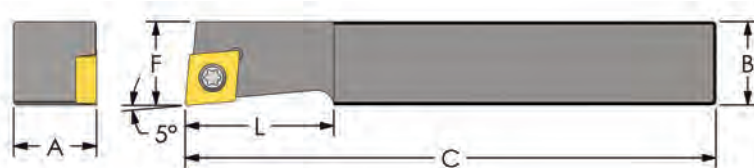

Positive 80° Diamond (-5° Lead)

No Coolant

Designation	A/B	C	L	F	Insert	Screw	Price
SCLCR/L 08-3A	.500	4	.865	.500	CCMT 32.51	MTS-35	\$67.00
SCLCR/L 10-3A	.625	4	1.120	.625		MTS-35	\$72.00

Designation	A/B (mm)	C (mm)	L (mm)	F (mm)	Insert	Screw	Price
SCLCR/L 1212-3A	12	100	22	12	CCMT 32.51	MTS-35	\$67.00
SCLCR/L 1616-3A	16	100	28	16		MTS-35	\$72.00

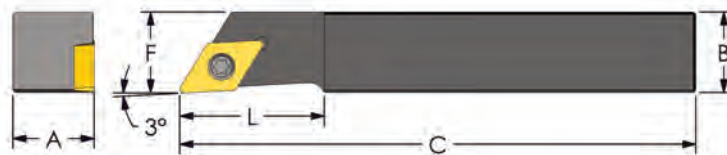

Positive 55° Diamond (-3° Lead)

No Coolant

Designation	A/B	C	L	F	Insert	Screw	Price
SDJCR/L 08-3A	.500	4	.865	.500	DCMT 32.51	MTS-35	\$67.00
SDJCR/L 10-3A	.625	4	1.120	.625		MTS-35	\$72.00

Designation	A/B (mm)	C (mm)	L (mm)	F (mm)	Insert	Screw	Price
SDJCR/L 1212-3A	12	100	22	12	DCMT 32.51	MTS-35	\$67.00
SDJCR/L 1616-3A	16	100	28	16		MTS-35	\$72.00



Hardware
pg: 186



Inserts
pg: 167

Proudly Made in Flushing, MI USA

A

TURNING

SQUARE Shank (Pullback)

A

TURNING

New

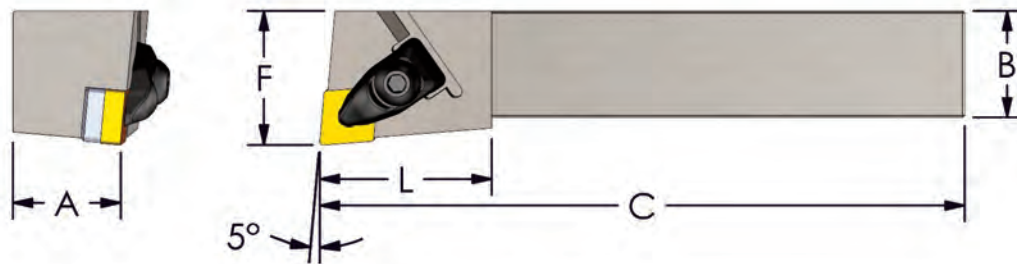

Negative 80° Diamond (-5° Lead)

No Coolant

Designation	A/B	C	L	F	Insert	Shim	Shim Screw	Clamp Assy	Price
DCLNR/L 12-4B	.750	4.5	1.300	1.000	CNMG 432	ICSN-433	PB4-SS	PB4-CA	\$79.00
DCLNR/L 16-4D	1.000	6	1.600	1.250		ICSN-433	PB4-SS	PB4-CA	\$87.00
DCLNR/L 20-4D	1.250	6	1.600	1.500		ICSN-433	PB4-SS	PB4-CA	\$96.00

New

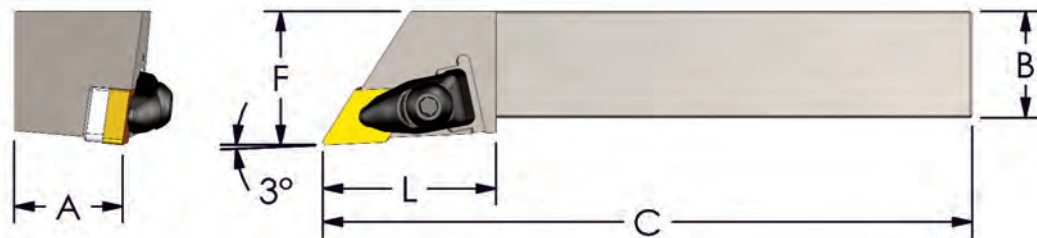

Negative 55° Diamond (3° Lead)

No Coolant

Designation	A/B	C	L	F	Insert	Shim	Shim Screw	Clamp Assy	Price
DDJNR/L 12-4B	.750	4.5	1.770	1.000	DNMG 432	IDSN-433	PB4-SS	PB4-CA	\$119.00
DDJNR/L 16-4D	1.000	6	1.600	1.250		IDSN-433	PB4-SS	PB4-CA	\$136.00
DDJNR/L 20-4D	1.250	6	1.600	1.500		IDSN-433	PB4-SS	PB4-CA	\$149.00

SQUARE Shank (Pullback)

New

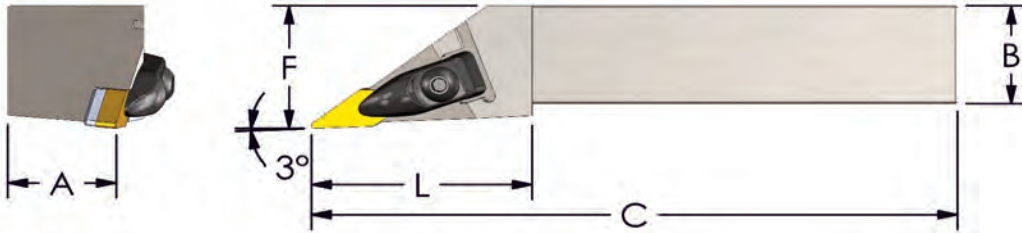

Negative 35° Diamond (-3° Lead)

No Coolant

Designation	A/B	C	L	F	Insert	Shim	Shim Screw	Clamp Assy	Price
DVJNR/L 12-3B	.750	4.5	1.770	1.000	VNMG 332	IVSN-322	PB3-SS	PB3L-CA	\$129.00
DVJNR/L 16-3D	1.000	6	1.600	1.250		IVSN-322	PB3-SS	PB3L-CA	\$136.00
DVJNR/L 20-3D	1.250	6	1.600	1.500		IVSN-322	PB3-SS	PB3L-CA	\$149.00

New

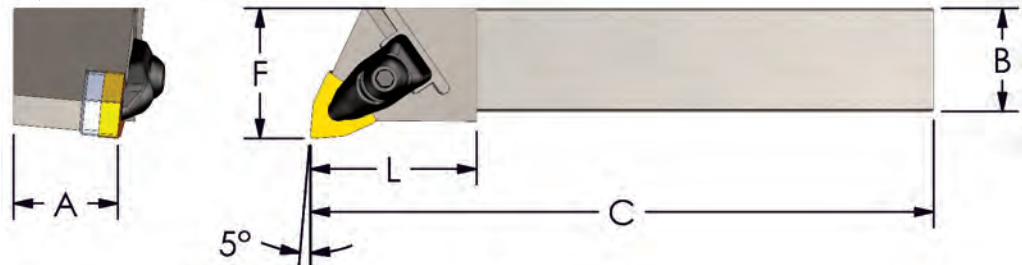

Negative Trigon (-5° Lead)

No Coolant

Designation	A/B	C	L	F	Insert	Shim	Shim Screw	Clamp Assy	Price
DWLNR/L 12-4B	.750	4.5	1.300	1.000	WNMG 432	IWSN-433	PB4-SS	PB4-CA	\$79.00
DWLNR/L 16-4D	1.000	6	1.600	1.250		IWSN-433	PB4-SS	PB4-CA	\$87.00
DWLNR/L 20-4D	1.250	6	1.600	1.500		IWSN-433	PB4-SS	PB4-CA	\$96.00

A

TURNING



Hardware
pg: 186



Inserts
pg: 167

ULTRA-DEX

Proudly Made in Flushing, MI USA

SQUARE Shank (80° Diamond)

A

TURNING

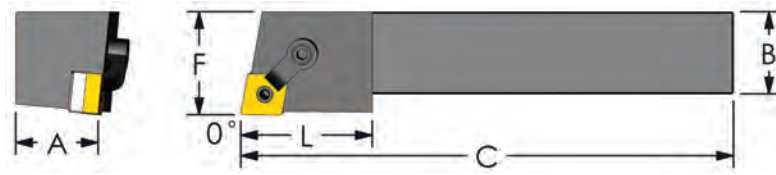

Negative 80° Diamond (0° Lead)

No Coolant

Designation	A/B	C	L	F	Insert	Shim	Lock Pin	Clamp	Screw	Price
MCGNR/L 12-4B	.750	4.5	1.300	1.000	CNMG 432	ICSN-433	NL-46	CL-20	XNS-48	\$67.00
MCGNR/L 16-4D	1.000	6	1.600	1.250		ICSN-433	NL-46	CL-20	XNS-48	\$73.00
MCGNR/L 20-4D	1.250	6	1.600	1.500		ICSN-433	NL-46	CL-20	XNS-48	\$80.00
MCGNR/L 24-4D	1.500	6	1.600	2.000		ICSN-433	NL-46	CL-20	XNS-48	\$106.00
MCGNR/L 16-5D	1.000	6	1.600	1.250	CNMG 543	ICSN-533	NL-58	CL-12	XNS-510	\$73.00
MCGNR/L 20-5D	1.250	6	1.600	1.500		ICSN-533	NL-58	CL-12	XNS-510	\$80.00
MCGNR/L 24-5D	1.500	6	1.600	2.000		ICSN-533	NL-58	CL-12	XNS-510	\$106.00
MCGNR/L 20-6D	1.250	6	1.600	1.500	CNMG 643	ICSN-633	NL-68	CL-12	XNS-510	\$80.00
MCGNR/L 24-6D	1.500	6	1.600	2.000		ICSN-633	NL-68	CL-12	XNS-510	\$106.00

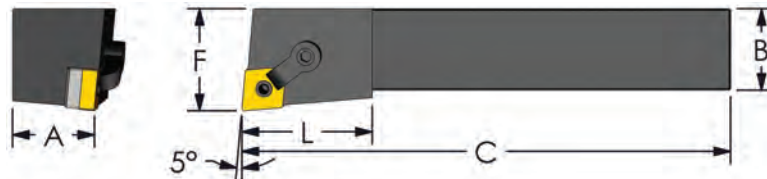

Negative 80° Diamond (-5° Lead)

No Coolant

Designation	A/B	C	L	F	Insert	Shim	Lock Pin	Clamp	Screw	Price
MCLNR/L 12-4B	.750	4.5	1.300	1.000	CNMG 432	ICSN-433	NL-46	CL-20	XNS-48	\$67.00
MCLNR/L 16-4D	1.000	6	1.600	1.250		ICSN-433	NL-46	CL-20	XNS-48	\$73.00
MCLNR/L 20-4D	1.250	6	1.600	1.500		ICSN-433	NL-46	CL-20	XNS-48	\$80.00
MCLNR/L 16-5D	1.000	6	1.600	1.250	CNMG 543	ICSN-533	NL-58	CL-12	XNS-510	\$73.00
MCLNR/L 20-5D	1.250	6	1.600	1.570		ICSN-533	NL-58	CL-12	XNS-510	\$80.00
MCLNR/L 24-5D	1.500	6	1.600	2.000		ICSN-533	NL-58	CL-12	XNS-510	\$106.00
MCLNR/L 16-6D	1.000	6	1.600	1.250	CNMG 643	ICSN-633	NL-68	CL-12	XNS-510	\$73.00
MCLNR/L 20-6D	1.250	6	1.600	1.570		ICSN-633	NL-68	CL-12	XNS-510	\$80.00
MCLNR/L 24-6D	1.500	6	1.600	2.000		ICSN-633	NL-68	CL-12	XNS-510	\$106.00
MCLNR/L 24-6E	1.500	7	1.600	2.000		ICSN-633	NL-68	CL-12	XNS-510	\$106.00

SQUARE Shank (80° Diamond)

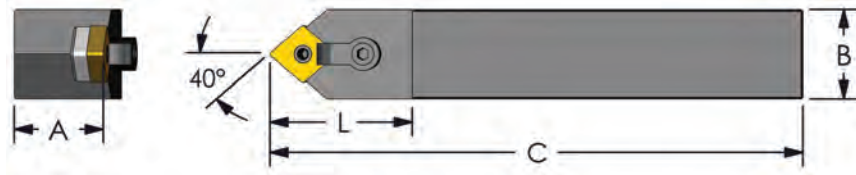

Negative 80° Diamond (40° Lead)

No Coolant

Designation Neutral	A/B	C	L	Insert	Shim	Lock Pin	Clamp	Screw	Price
MCMNN 12-4B	.750	4.5	1.300	CNMG 432	ICSN-433	NL-46	CL-20	XNS-48	\$67.00
MCMNN 16-4D	1.000	6	1.600		ICSN-433	NL-46	CL-20	XNS-48	\$73.00
MCMNN 20-4D	1.250	6	1.600		ICSN-433	NL-46	CL-20	XNS-48	\$80.00
MCMNN 16-5D	1.000	6	1.600	CNMG 543	ICSN-533	NL-58	CL-12	XNS-510	\$73.00
MCMNN 20-5D	1.250	6	1.600		ICSN-533	NL-58	CL-12	XNS-510	\$80.00
MCMNN 24-5D	1.500	6	1.600		ICSN-533	NL-58	CL-12	XNS-510	\$106.00
MCMNN 24-6D	1.500	6	2.050	CNMG 643	ICSN-633	NL-68	CL-12	XNS-510	\$106.00
MCMNN 24-6E	1.500	7	2.050		ICSN-633	NL-68	CL-12	XNS-510	\$106.00

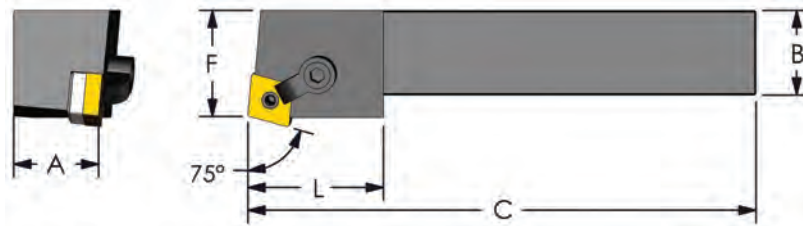

Negative 80° Diamond (75° Lead)

No Coolant

Designation	A/B	C	L	F	Insert	Shim	Lock Pin	Clamp	Screw	Price
MCRNR/L 12-4B	.750	4.5	1.300	.750	CNMG 432	ICSN-433	NL-46	CL-20	XNS-48	\$67.00
MCRNR/L 16-4C	1.000	5	1.600	1.250		ICSN-433	NL-46	CL-20	XNS-48	\$73.00
MCRNR/L 16-4D	1.000	6	1.600	1.250		ICSN-433	NL-46	CL-20	XNS-48	\$73.00
MCRNR/L 20-4D	1.250	6	1.600	1.500		ICSN-433	NL-46	CL-20	XNS-48	\$80.00
MCRNR/L 24-4D	1.500	6	1.600	2.000		ICSN-433	NL-46	CL-20	XNS-48	\$106.00
MCRNR/L 16-5D	1.000	6	1.600	1.250	CNMG 543	ICSN-533	NL-58	CL-12	XNS-510	\$73.00
MCRNR/L 20-5D	1.250	6	1.600	1.500		ICSN-533	NL-58	CL-12	XNS-510	\$80.00
MCRNR/L 16-6D	1.000	6	1.600	1.250	CNMG 643	ICSN-633	NL-68	CL-12	XNS-510	\$73.00
MCRNR/L 20-6D	1.250	6	1.600	1.500		ICSN-633	NL-68	CL-12	XNS-510	\$80.00
MCRNR/L 24-6D	1.500	6	1.600	2.000		ICSN-633	NL-68	CL-12	XNS-510	\$106.00



Hardware
pg: 186



Inserts
pg: 167

Proudly Made in Flushing, MI USA

A

TURNING



SQUARE Shank (80° Diamond)

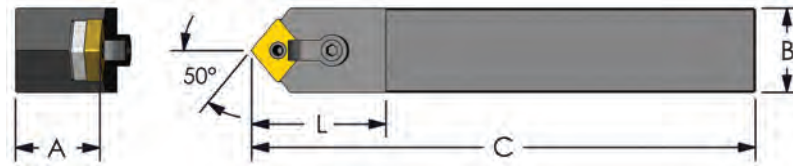

Negative 80° Diamond (50° Lead)

No Coolant

Designation Neutral	A/B	C	L	Insert	Shim	Lock Pin	Clamp	Screw	Price
MCYNN 12-4B	.750	4.5	1.300	CNMG 432	ICSN-433	NL-46	CL-20	XNS-48	\$67.00
MCYNN 16-4D	1.000	6	1.600		ICSN-433	NL-46	CL-20	XNS-48	\$73.00
MCYNN 20-4D	1.250	6	1.600		ICSN-433	NL-46	CL-20	XNS-48	\$80.00
MCYNN 16-5D	1.000	6	1.600	CNMG 543	ICSN-533	NL-58	CL-12	XNS-510	\$73.00
MCYNN 20-5D	1.250	6	1.600		ICSN-533	NL-58	CL-12	XNS-510	\$80.00
MCYNN 16-6D	1.000	6	2.050	CNMG 643	ICSN-633	NL-68	CL-12	XNS-510	\$73.00
MCYNN 20-6D	1.250	6	2.050		ICSN-633	NL-68	CL-12	XNS-510	\$80.00
MCYNN 24-6D	1.500	6	2.050		ICSN-633	NL-68	CL-12	XNS-510	\$106.00

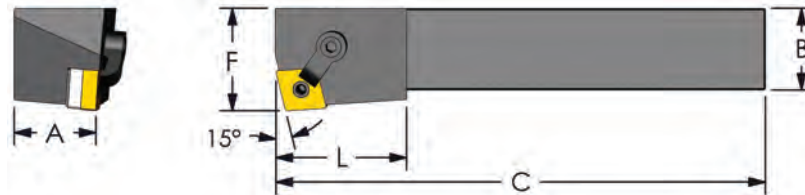

Negative 80° Diamond (15° Lead)

No Coolant

Designation	A/B	C	L	F	Insert	Shim	Lock Pin	Clamp	Screw	Price
MCKNR/L 12-4B	.750	4.5	1.300	1.000	CNMG 432	ICSN-433	NL-46	CL-20	XNS-48	\$67.00
MCKNR/L 16-4D	1.000	6	1.600	1.250		ICSN-433	NL-46	CL-20	XNS-48	\$73.00
MCKNR/L 20-4D	1.250	6	1.600	1.500		ICSN-433	NL-46	CL-20	XNS-48	\$80.00
MCKNR/L 16-5D	1.000	6	1.600	1.250	CNMG 543	ICSN-533	NL-58	CL-12	XNS-510	\$73.00
MCKNR/L 20-5D	1.250	6	1.600	1.500		ICSN-533	NL-58	CL-12	XNS-510	\$80.00
MCKNR/L 16-6D	1.000	6	1.600	1.250	CNMG 643	ICSN-633	NL-68	CL-12	XNS-510	\$73.00
MCKNR/L 20-6D	1.250	6	1.600	1.500		ICSN-633	NL-68	CL-12	XNS-510	\$80.00
MCKNR/L 24-6D	1.500	6	1.600	2.000		ICSN-633	NL-68	CL-12	XNS-510	\$106.00
MCKNR/L 24-6E	1.500	7	1.600	2.000		ICSN-633	NL-68	CL-12	XNS-510	\$106.00

A

TURNING



SQUARE Shank (55° Diamond)

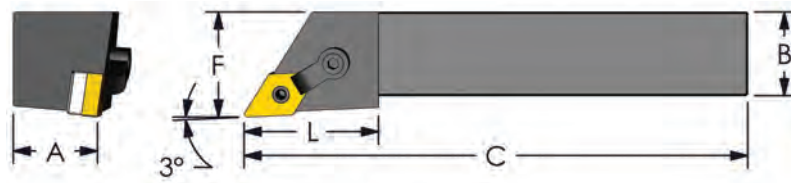

Negative 55° Diamond (3° Lead)

No Coolant

Designation	A/B	C	L	F	Insert	Shim	Lock Pin	Clamp	Screw	Price
MDJNR/L 12-4B	.750	4.5	1.770	1.000	DNMG 432	IDSN-433	NL-46	CL-20	XNS-48	\$95.00
MDJNR/L 16-4D	1.000	6	1.600	1.250		IDSN-433	NL-46	CL-20	XNS-48	\$107.00
MDJNR/L 20-4D	1.250	6	1.600	1.500		IDSN-433	NL-46	CL-20	XNS-48	\$123.00
MDJNR/L 24-4D	1.500	6	1.600	2.000		IDSN-433	NL-46	CL-20	XNS-48	\$129.00
MDJNR/L 16-5D	1.000	6	1.600	1.250	DNMG 543	IDSN-533	NL-58	CL-12	XNS-510	\$107.00
MDJNR/L 20-5D	1.250	6	1.600	1.500		IDSN-533	NL-58	CL-12	XNS-510	\$123.00
MDJNR/L 24-5D	1.500	6	2.050	2.000		IDSN-533	NL-58	CL-12	XNS-510	\$129.00

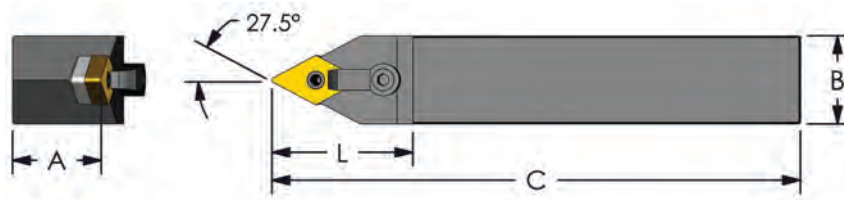

Negative 55° Diamond (27.5° Lead)

No Coolant

Designation Neutral	A/B	C	L	Insert	Shim	Lock Pin	Clamp	Screw	Price
MDPNN 12-4B	.750	4.5	1.770	DNMG 432	IDSN-433	NL-46	CL-22	XNS-48	\$104.00
MDPNN 16-4D	1.000	6	1.600		IDSN-433	NL-46	CL-22	XNS-48	\$108.00
MDPNN 20-4D	1.250	6	1.600		IDSN-433	NL-46	CL-22	XNS-48	\$120.00
MDPNN 16-5D	1.000	6	2.050	DNMG 543	IDSN-533	NL-58	CL-12	XNS-510	\$108.00
MDPNN 20-5D	1.250	6	2.050		IDSN-533	NL-58	CL-12	XNS-510	\$120.00
MDPNN 24-5D	1.500	6	2.050		IDSN-533	NL-58	CL-12	XNS-510	\$129.00
MDPNN 24-5E	1.500	7	2.050		IDSN-533	NL-58	CL-12	XNS-510	\$129.00



Hardware
pg: 186



Inserts
pg: 167

Proudly Made in Flushing, MI USA

A

TURNING

SQUARE Shank (Negative Round/Square)

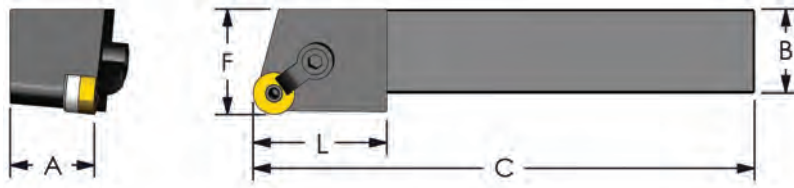

Negative Round (0° Lead)

No Coolant

Designation	A/B	C	L	F	Insert	Shim	Lock Pin	Clamp	Screw	Price
MRGNR/L 12-3B	.750	4.5	1.300	1.000	RNMG 32	IRSN-32	NL-34	CL-6	XNS-36	\$67.00
MRGNR/L 12-4B	.750	4.5	1.300	1.000	RNMG 43	IRSN-43	NL-46	CL-20	XNS-48	\$67.00
MRGNR/L 16-4D	1.000	6	1.600	1.250		IRSN-43	NL-46	CL-20	XNS-48	\$73.00
MRGNR/L 20-4D	1.250	6	1.600	1.500	RNMG 54	IRSN-43	NL-46	CL-20	XNS-48	\$80.00
MRGNR/L 16-5D	1.000	6	1.600	1.250		IRSN-53	NL-58	CL-12	XNS-510	\$73.00
MRGNR/L 20-5D	1.250	6	1.600	1.500	IRSN-53	NL-58	CL-12	XNS-510	\$80.00	
MRGNR/L 16-6D	1.000	6	1.600	1.250	RNMG 64	IRSN-63	NL-68	CL-12	XNS-510	\$73.00
MRGNR/L 20-6D	1.250	6	1.600	1.500		IRSN-63	NL-68	CL-12	XNS-510	\$80.00
MRGNR/L 24-6D	1.500	6	1.600	2.000	IRSN-63	NL-68	CL-12	XNS-510	\$106.00	

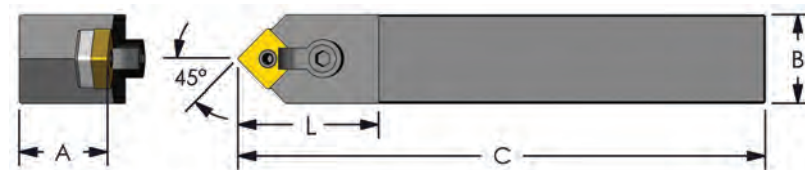

Negative Square (45° Lead)

No Coolant

Designation Neutral	A/B	C	L	Insert	Shim	Lock Pin	Clamp	Screw	Price
MSDNN 12-4B	.750	4.5	1.300	SNMG 432	ISSN-433	NL-46	CL-20	XNS-48	\$67.00
MSDNN 16-4D	1.000	6	1.600		ISSN-433	NL-46	CL-20	XNS-48	\$73.00
MSDNN 16-5D	1.000	6	1.600	SNMG 543	ISSN-533	NL-58	CL-12	XNS-510	\$73.00
MSDNN 20-5D	1.250	6	1.600		ISSN-533	NL-58	CL-12	XNS-510	\$80.00
MSDNN 16-6D	1.000	6	1.600	SNMG 643	ISSN-633	NL-68	CL-12	XNS-510	\$73.00
MSDNN 20-6D	1.250	6	1.600		ISSN-633	NL-68	CL-12	XNS-510	\$80.00
MSDNN 24-6D	1.500	6	1.600		ISSN-633	NL-68	CL-12	XNS-510	\$106.00

A

TURNING

SQUARE Shank (Negative Square)

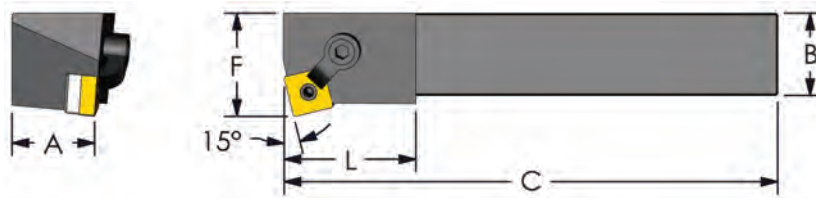

Negative Square (15° Lead) End Cutting

No Coolant

Designation	A/B	C	L	F	Insert	Shim	Lock Pin	Clamp	Screw	Price
MSKNR/L 12-4B	.750	4.5	1.300	1.000	SNMG 432	ISSN-433	NL-46	CL-20	XNS-48	\$67.00
MSKNR/L 16-4D	1.000	6	1.600	1.250		ISSN-433	NL-46	CL-20	XNS-48	\$73.00
MSKNR/L 16-5D	1.000	6	1.600	1.250	SNMG 543	ISSN-533	NL-58	CL-12	XNS-510	\$73.00
MSKNR/L 20-5D	1.250	6	1.600	1.500		ISSN-533	NL-58	CL-12	XNS-510	\$80.00
MSKNR/L 20-6D	1.250	6	1.600	1.500	SNMG 643	ISSN-633	NL-68	CL-12	XNS-510	\$80.00
MSKNR/L 24-6D	1.500	6	1.600	2.000		ISSN-633	NL-68	CL-12	XNS-510	\$106.00

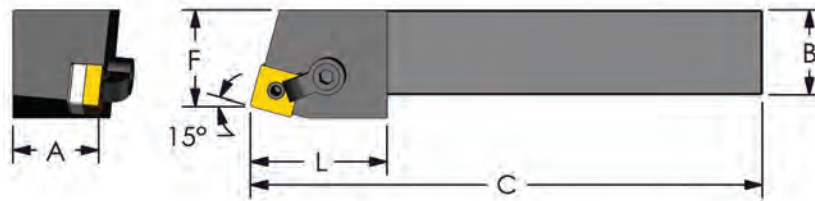

Negative Square (15° Lead) Side Cutting

No Coolant

Designation	A/B	C	L	F	Insert	Shim	Lock Pin	Clamp	Screw	Price
MSRNR/L 12-4B	.750	4.5	1.300	.880	SNMG 432	ISSN-433	NL-46	CL-20	XNS-48	\$67.00
MSRNR/L 16-4D	1.000	6	1.600	1.130		ISSN-433	NL-46	CL-20	XNS-48	\$73.00
MSRNR/L 20-4D	1.250	6	1.600	1.380		ISSN-433	NL-46	CL-20	XNS-48	\$80.00
MSRNR/L 16-5D	1.000	6	1.600	1.103	SNMG 543	ISSN-533	NL-58	CL-12	XNS-510	\$73.00
MSRNR/L 20-5D	1.250	6	1.600	1.353		ISSN-533	NL-58	CL-12	XNS-510	\$80.00
MSRNR/L 16-6D	1.000	6	1.600	1.071	SNMG 643	ISSN-633	NL-68	CL-12	XNS-510	\$73.00
MSRNR/L 20-6D	1.250	6	1.600	1.315		ISSN-633	NL-68	CL-12	XNS-510	\$80.00
MSRNR/L 24-6D	1.500	6	1.600	1.821		ISSN-633	NL-68	CL-12	XNS-510	\$106.00

A

TURNING



Hardware
pg: 186



Inserts
pg: 167

Proudly Made in Flushing, MI USA

SQUARE Shank (Negative Square/Triangle)

A

TURNING

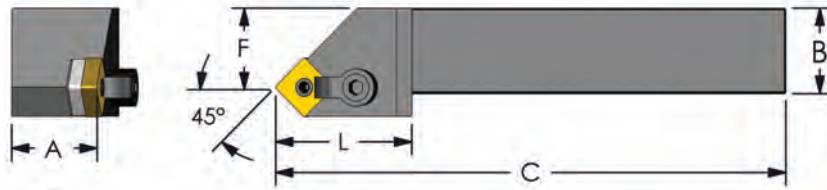

Negative Square (45° Lead)

No Coolant

Designation	A/B	C	L	F	Insert	Shim	Lock Pin	Clamp	Screw	Price
MSSNR/L 12-4B	.750	4.5	1.300	.675	SNMG 432	ISSN-433	NL-46	CL-20	XNS-48	\$67.00
MSSNR/L 16-4D	1.000	6	1.600	.925		ISSN-433	NL-46	CL-20	XNS-48	\$73.00
MSSNR/L 16-5D	1.000	6	1.600	.847	SNMG 543	ISSN-533	NL-58	CL-12	XNS-510	\$73.00
MSSNR/L 20-5D	1.250	6	1.600	1.097		ISSN-533	NL-58	CL-12	XNS-510	\$80.00
MSSNR/L 20-6D	1.250	6	1.600	1.011	SNMG 643	ISSN-633	NL-68	CL-12	XNS-510	\$80.00
MSSNR/L 24-6D	1.500	6	1.600	1.511		ISSN-633	NL-68	CL-12	XNS-510	\$106.00

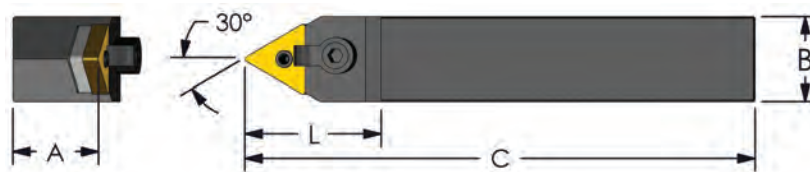

Negative Triangle (30° Lead)

No Coolant

Designation Neutral	A/B	C	L	Insert	Shim	Lock Pin	Clamp	Screw	Price
MTENN 10-3B	.625	4.5	1.120	TNMG 332	ITSN-323	NL-34L	CL-6	XNS-36	\$58.00
MTENN 12-3B	.750	4.5	1.300		ITSN-323	NL-34L	CL-6	XNS-36	\$67.00
MTENN 12-4B	.750	4.5	1.770	TNMG 432	ITSN-433	NL-46	CL-20	XNS-48	\$67.00
MTENN 16-4D	1.000	6	1.600		ITSN-433	NL-46	CL-20	XNS-48	\$73.00
MTENN 20-5D	1.250	6	1.600	TNMG 543	ITSN-533	NL-58	CL-9	XNS-510	\$80.00
MTENN 24-5D	1.500	6	1.600		ITSN-533	NL-58	CL-9	XNS-510	\$106.00

SQUARE Shank (Negative Triangle)

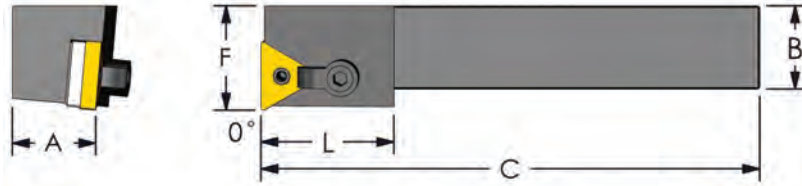

Negative Triangle (0° Lead) End Cutting

No Coolant

Designation	A/B	C	L	F	Insert	Shim	Lock Pin	Clamp	Screw	Price
MTFNR/L 12-3B	.750	4.5	1.300	1.000	TNMG 332	ITSN-323	NL-34L	CL-6	XNS-36	\$67.00
MTFNR/L 16-3D	1.000	6	1.600	1.250		ITSN-323	NL-34L	CL-6	XNS-36	\$73.00
MTFNR/L 16-4D	1.000	6	1.600	1.250	TNMG 432	ITSN-433	NL-46	CL-20	XNS-48	\$73.00
MTFNR/L 20-4D	1.250	6	1.600	1.500		ITSN-433	NL-46	CL-20	XNS-48	\$80.00
MTFNR/L 16-5D	1.000	6	1.600	1.250	TNMG 543	ITSN-533	NL-58	CL-12	XNS-510	\$73.00
MTFNR/L 20-5D	1.250	6	1.600	1.500		ITSN-533	NL-58	CL-12	XNS-510	\$80.00
MTFNR/L 24-5D	1.500	6	1.600	2.000		ITSN-533	NL-58	CL-12	XNS-510	\$106.00
MTFNR/L 24-6D	1.500	6	1.600	2.000	TNMG 663	ITSN-636	NL-68L	CL-12	XNS-510	\$106.00

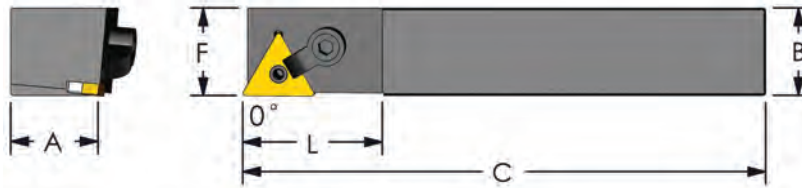

Negative Triangle (0° Lead) Side Cutting

No Coolant

Designation	A/B	C	L	F	Insert	Shim	Lock Pin	Clamp	Screw	Price
MTANR/L 12-3B	.750	4.5	1.300	.750	TNMG 332	ITSN-323	NL-34L	CL-6	XNS-36	\$73.00
MTANR/L 16-3D	1.000	6	1.600	1.000		ITSN-323	NL-34L	CL-6	XNS-36	\$75.00
MTANR/L 16-4D	1.000	6	1.600	1.000	TNMG 432	ITSN-433	NL-46	CL-20	XNS-48	\$75.00
MTANR/L 20-5D	1.250	6	1.600	1.250	TNMG 543	ITSN-533	NL-58	CL-12	XNS-510	\$82.00
MTANR/L 24-5D	1.500	6	1.600	1.500		ITSN-533	NL-58	CL-12	XNS-510	\$107.00
MTANR/L 24-6D	1.500	6	1.600	1.500	TNMG 663	ITSN-636	NL-68L	CL-12	XNS-510	\$107.00

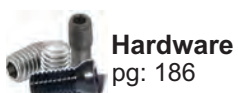

Hardware
pg: 186



Inserts
pg: 167

ULTRA-DEX

Prices are subject to change without notice.

A

TURNING



SQUARE Shank (Negative Triangle)

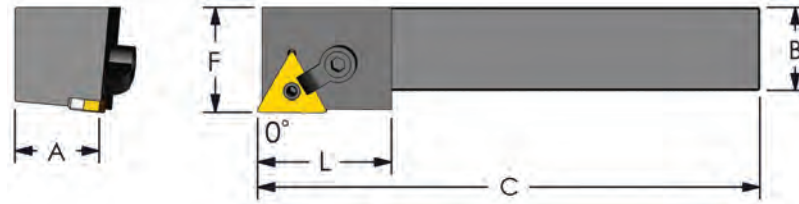

Negative Triangle (0° Lead) Side Cutting TNMG

No Coolant

Designation	A/B	C	L	F	Insert	Shim	Lock Pin	Clamp	Screw	Price
MTGNR/L 10-3B	.625	4.5	1.120	.875	TNMG 332	ITSN-323	NL-34L	CL-6	XNS-36	\$58.00
MTGNR/L 12-3B	.750	4.5	1.300	1.000		ITSN-323	NL-34L	CL-6	XNS-36	\$67.00
MTGNR/L 16-3D	1.000	6	1.600	1.250		ITSN-323	NL-34L	CL-6	XNS-36	\$73.00
MTGNR/L 16-4D	1.000	6	1.600	1.250	TNMG 432	ITSN-433	NL-46	CL-20	XNS-48	\$73.00
MTGNR/L 20-4D	1.250	6	1.600	1.500		ITSN-433	NL-46	CL-20	XNS-48	\$80.00
MTGNR/L 24-4D	1.500	6	1.600	2.000		ITSN-433	NL-46	CL-20	XNS-48	\$97.00
MTGNR/L 24-4E	1.500	7	1.600	2.000		ITSN-433	NL-46	CL-20	XNS-48	\$97.00
MTGNR/L 16-5D	1.000	6	1.600	1.250	TNMG 543	ITSN-533	NL-58	CL-9	XNS-510	\$73.00
MTGNR/L 20-5D	1.250	6	1.600	1.500		ITSN-533	NL-58	CL-9	XNS-510	\$80.00
MTGNR/L 24-5D	1.500	6	1.600	2.000		ITSN-533	NL-58	CL-9	XNS-510	\$106.00

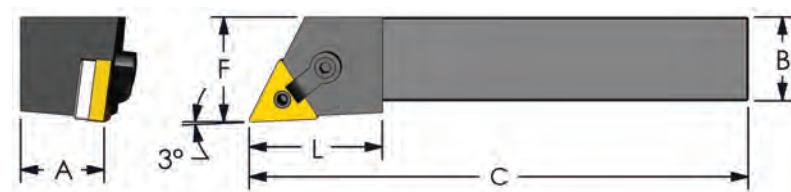

Negative Triangle (3° Lead)

No Coolant

Designation	A/B	C	L	F	Insert	Shim	Lock Pin	Clamp	Screw	Price
MTJNR/L 12-3B	.750	4.5	1.300	1.000	TNMG 332	ITSN-323	NL-34L	CL-6	XNS-36	\$67.00
MTJNR/L 16-3D	1.000	6	1.600	1.250		ITSN-323	NL-34L	CL-6	XNS-36	\$73.00
MTJNR/L 16-4D	1.000	6	1.600	1.250	TNMG 432	ITSN-433	NL-46	CL-20	XNS-48	\$73.00
MTJNR/L 20-4D	1.250	6	1.600	1.500		ITSN-433	NL-46	CL-20	XNS-48	\$80.00
MTJNR/L 16-5D	1.000	6	1.600	1.250	TNMG 543	ITSN-533	NL-58	CL-9	XNS-510	\$73.00
MTJNR/L 20-5D	1.250	6	1.600	1.500		ITSN-533	NL-58	CL-9	XNS-510	\$80.00
MTJNR/L 24-5D	1.500	6	1.600	2.000		ITSN-533	NL-58	CL-9	XNS-510	\$106.00
MTJNR/L 24-6D	1.500	6	1.600	2.000		TNMG 663	ITSN-636	NL-68L	CL-12	XNS-510

A

TURNING



SQUARE Shank(Negative Diamond/Trigon)

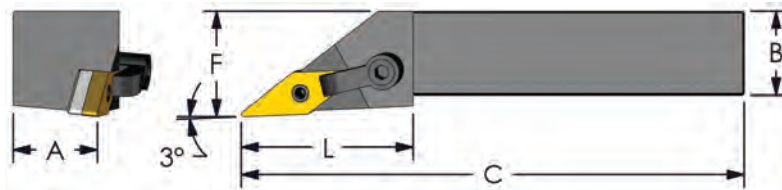

Negative 35° Diamond (-3° Lead)

No Coolant

Designation	A/B	C	L	F	Insert	Shim	Lock Pin	Clamp	Screw	Price
MVJNR/L 12-3B	.750	4.5	1.770	1.000	VNMG 332	IVSN-322	NL-34L	CL-22	XNS-48	\$110.00
MVJNR/L 16-3D	1.000	6	1.600	1.250		IVSN-322	NL-34L	CL-22	XNS-48	\$114.00
MVJNR/L 20-3D	1.250	6	1.600	1.500		IVSN-322	NL-34L	CL-22	XNS-48	\$122.00
MVJNR/L 16-4D	1.000	6	2.050	1.250	VNMG 432	IVSN-432	NL-46	CL-30	XNS-510	\$114.00
MVJNR/L 20-4D	1.250	6	2.050	1.500		IVSN-432	NL-46	CL-30	XNS-510	\$122.00
MVJNR/L 24-4D	1.500	6	2.050	2.000		IVSN-432	NL-46	CL-30	XNS-510	\$136.00

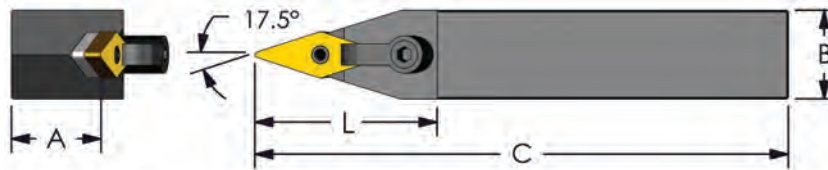

Negative 35° Diamond (17.5° Lead)

No Coolant

Designation Neutral	A/B	C	L	Insert	Shim	Lock Pin	Clamp	Screw	Price
MVVNN 12-3B	.750	4.5	1.770	VNMG 332	IVSN-322	NL-34L	CL-30	XNS-510	\$110.00
MVVNN 16-3D	1.000	6	2.050		IVSN-322	NL-34L	CL-30	XNS-510	\$114.00
MVVNN 20-3D	1.250	6	2.050		IVSN-322	NL-34L	CL-30	XNS-510	\$122.00
MVVNN 24-3D	1.500	6	2.050		IVSN-322	NL-34L	CL-30	XNS-510	\$136.00
MVVNN 16-4D	1.000	6	2.050	VNMG 432	IVSN-432	NL-46	CL-30	XNS-510	\$114.00
MVVNN 20-4D	1.250	6	2.050		IVSN-432	NL-46	CL-30	XNS-510	\$122.00
MVVNN 24-4D	1.500	6	2.050		IVSN-432	NL-46	CL-30	XNS-510	\$136.00

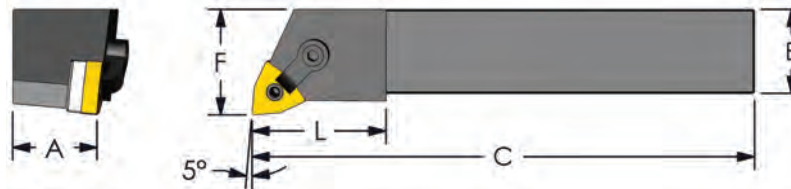

Negative Trigon (-5° Lead)

No Coolant

Designation	A/B	C	L	F	Insert	Shim	Lock Pin	Clamp	Screw	Price
MWLNR/L 12-3B	.750	4.5	1.300	1.000	WNMG 332	IWSN-322	NL-34L	CL-6	XNS-36	\$67.00
MWLNR/L 12-4B	.750	4.5	1.300	1.000	WNMG 432	IWSN-433	NL-46	CL-20	XNS-48	\$67.00
MWLNR/L 16-4D	1.000	6	1.600	1.250		IWSN-433	NL-46	CL-20	XNS-48	\$73.00
MWLNR/L 20-4D	1.250	6	1.600	1.500		IWSN-433	NL-46	CL-20	XNS-48	\$80.00
MWLNR/L 24-4D	1.500	6	1.600	2.000		IWSN-433	NL-46	CL-20	XNS-48	\$106.00



Hardware
pg: 186



Inserts
pg: 167

Proudly Made in Flushing, MI USA

A

TURNING



SQUARE Shank (Top Notch / Laydown)

A

TURNING

SQUARE SHANK

Threading/Grooving Top Notch & Laydown

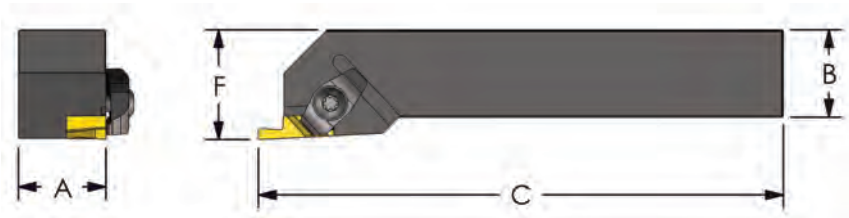

Threading/Grooving Top Notch

No Coolant

Designation	A/B	C	L	F	Insert	RH Clamp	LH Clamp	Clamp Screw	Price
NSR/L 12-3B	.750	4.5	1.300	1.000	NG 3R/3L	CM-72	CM-73	10-32	\$74.00
NSR/L 16-3D	1.000	6	1.600	1.250		CM-72	CM-73	10-32	\$81.00

Threading/Grooving Top Notch

No Coolant

Designation	A/B	C	L	F	Insert	RH Clamp	LH Clamp	Clamp Screw	Price
NSR/L 12-4B	.750	4.5	1.300	1.000	NG 4R/4L	CM-72	CM-73	10-32	\$74.00
NSR/L 16-4D	1.000	6	1.600	1.250		CM-72	CM-73	10-32	\$81.00

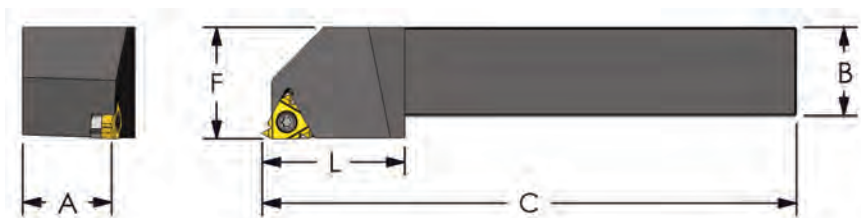

Threading/Grooving Laydown

No Coolant

Designation	A/B	C	L	F	Insert	Insert Screw	Anvil Screw	Anvil Right	Anvil Left	Price
LSSR/L 12-3B	.750	4.5	1.300	1.000	3 IL/IR	SA3T	SY3T	YE3	YI3	\$71.00
LSSR/L 16-3D	1.000	6	1.600	1.250		SA3T	SY3T	YE3	YI3	\$77.00



Boring Bar NOMENCLATURE

Bar Type	
A	Solid Steel Bar with Coolant
C	Carbide Bar
D	Chatter-Free with Coolant
E	Carbide Bar with Coolant
HM	Solid Heavy Metal with Coolant
J	Solid Heavy Metal
R	Carbide Reinforced Steel Bar
S	Solid Steel Bar

Bar Length	
F	3"
G	3.5"
H	4"
J	4.5"
K	5"
M	6"
Q	7"
R	8"
X	9"
S	10"
T	12"
U	14"
V	16"
W	20"

Insert Clearance Angle		
B	5°	
C	7°	
D	15°	
N	0°	
P	11°	

Alternate F Dim.	
138	.138"
167	.167"
203	.203"
281	.281"

E 10 Q S C L C R 2 -281

Bar Diameter	
02.5	.156" (5/32")
03	.187" (3/16")
03.5	.218" (7/32")
04	.250" (1/4")
05	.312" (5/16")
06	.375" (3/8")
08	.500" (1/2")
10	.625" (5/8")
12	.750" (3/4")
16	1.000" (1")
20	1.250" (1 1/4")
24	1.500" (1 1/2")
28	1.750" (1 3/4")
32	2.000" (2")

Insert Holding	
M	Clamp and Lock Pin
N	Top Notch Clamp
S	Screw Lock Only
D	PULLBACK Clamp

Insert Shape	
C	80° Diamond
D	55° Diamond
T	60° Triangle
S	90° Square
V	35° Diamond
W	80° Trigon
R	Round

Lead Angle	
F	0°
J	-52°
K	15°
L	-5°
N	27.5°
Q	-17.5°
U	-3°
X	5°

Insert Size	
1.2	5/32" IC
1.5	3/16" IC
1.8	7/32" IC
2	1/4" IC
2.5	5/16" IC
3	3/8" IC
4	1/2" IC

Hand of Bar	
L	Left
R	Right

B
BORING

Series Boring Bar NOMENCLATURE

B
BORING

Series
C
F
G
S
Q

Bar Length	
2.5	2.5"
3	3"
3.5	3.5"
4	4"
5	5"
6	6"
7	7"
8	8"
10	10"
12	12"



Lead Angle		
0	0°	
3	-3°	
5	-5°	
7	-7°	

C **C** **UD** - **187** - **4** - **5** **L**

Material	
C	Carbide
S	Steel

ULTRA-DEX

D Diameter	
187	.187"
250	.250"
312	.312"
375	.375"
500	.500"
625	.625"
750	.750"
1000	1.000"
1250	1.250"

Hand of Bar	
L	Left 
R	Right 



Series Style Boring Bars
pgs 26, 28, 45, 51, 52, 58, 64

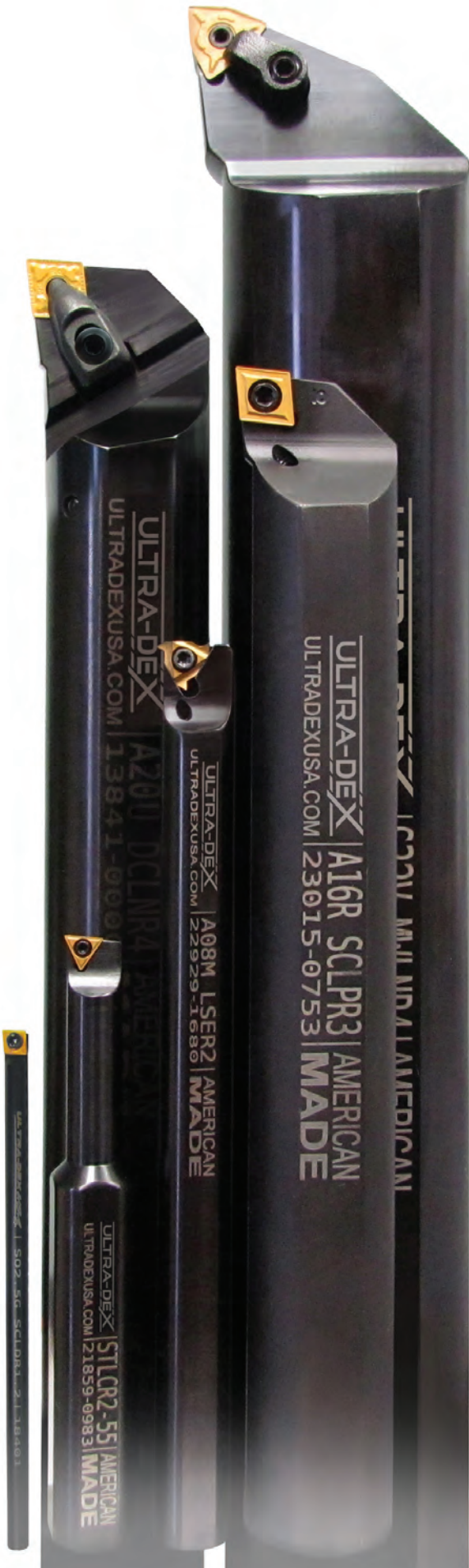

STEEL BORING BARS

The *ECONOMICAL CHOICE* for general machining

4:1 Ratio

.156" - 2" Diameters

MADE  HERE

Other Pages of Interest

Pg 42 [Boring Kits](#)

Pg 43 [Reduced Neck Bars](#)

ULTRA-DEX

Proudly Made in Flushing, MI USA

B

BORING

Steel Boring Bars (Positive)

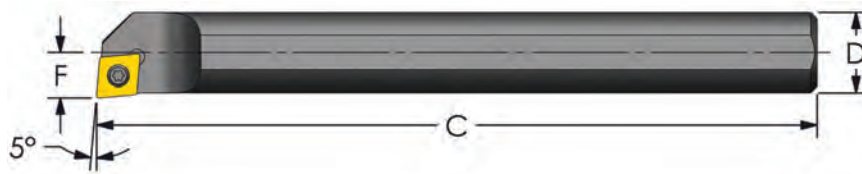

4:1 Ratio

Positive 80° Diamond (-5° Lead)

No Coolant

Designation	D Dia.	C OAL	F	Min Bore	Insert	Insert Screw	Key	Price
S02.5G SCLDR/L1.2 *	.156	3.5	.090	.175	CDHB 1.20.60	MTS-182	T-6	\$53.00
S03G SCLDR/L1.2 *	.187	3.5	.102	.205		MTS-183	T-6	\$53.00
S03.5G SCLDR/L1.5 *	.218	3.5	.125	.245	CDGW 1.510	MTS-184	T-6	\$53.00
S04G SCLDR/L1.5 *	.250	3.5	.172	.312		MTS-184	T-6	\$53.00
S05G SCLPR/L1.8 *	.312	3.5	.219	.395	CPMT 1.81.20.5	MTS-224	T-7	\$53.00
S06K SCLPR/L2	.375	5	.250	.460	CPMT 21.51	MTS-255	T-7	\$59.00
S08M SCLPR/L2	.500	6	.312	.600		MTS-255	T-7	\$66.00
S10Q SCLPR/L2	.625	7	.406	.760		MTS-255	T-7	\$82.00
S08M SCLPR/L3	.500	6	.344	.625	CPMT 32.51	MTS-35	T-15	\$66.00
S10Q SCLPR/L3	.625	7	.406	.760		MTS-35	T-15	\$82.00
S12Q SCLPR/L3	.750	7	.500	.920		MTS-35	T-15	\$94.00
S16R SCLPR/L3	1.000	8	.625	1.185		MTS-35	T-15	\$130.00
S06K SCLCR/L2	.375	5	.250	.460	CCMT 21.51	MTS-255	T-7	\$59.00
S08M SCLCR/L2	.500	6	.312	.600		MTS-255	T-7	\$66.00
S10Q SCLCR/L2	.625	7	.406	.760		MTS-255	T-7	\$82.00
S08M SCLCR/L3	.500	6	.344	.625	CCMT 32.51	MTS-35	T-15	\$66.00
S10Q SCLCR/L3	.625	7	.406	.760		MTS-35	T-15	\$82.00
S12Q SCLCR/L3	.750	7	.500	.920		MTS-35	T-15	\$94.00
S12S SCLCR3	.750	10	.500	.920		MTS-35	T-15	\$101.00
S16R SCLCR/L3	1.000	8	.625	1.185		MTS-35	T-15	\$130.00
S16T SCLCR3	1.000	12	.625	1.185		MTS-35	T-15	\$147.00
S20U SCLCR/L3	1.250	14	.765	1.465	CCMT 432	MTS-35	T-15	\$184.00
S20U SCLCR/L4	1.250	14	.765	1.465		MTS-4	T-20	\$202.00
S24U SCLCR/L4	1.500	14	.890	1.730		MTS-4	T-20	\$226.00

New

Also available in: Carbide pg: 48 Heavy Metal pg: 68

Minimum Clearance

No Coolant

Designation	D Dia.	C OAL	F	Min Bore	Insert	Insert Screw	Key	Price
S04G SCLDR/L1.5-138 *	.250	3.5	.138	.275	CDGW 1.510	MTS-184	T-6	\$53.00
S05G SCLPR/L1.8-167 *	.312	3.5	.167	.340	CPMT 1.81.20.5	MTS-224	T-7	\$53.00
S06K SCLPR/L2-203	.375	5	.203	.410	CPMT 21.51	MTS-255	T-7	\$59.00
S08M SCLPR/L2-281	.500	6	.281	.560		MTS-255	T-7	\$66.00
S06K SCLCR/L2-203	.375	5	.203	.410	CCMT 21.51	MTS-255	T-7	\$59.00
S08M SCLCR/L2-281	.500	6	.281	.560		MTS-255	T-7	\$66.00

Minimum Clearance Bars are intended for light machining with minimum bore clearance. Max depth of cut .015" - .020"
 * bars .312 and smaller do not have flats

B
BORING

Steel Boring Bars (Positive)

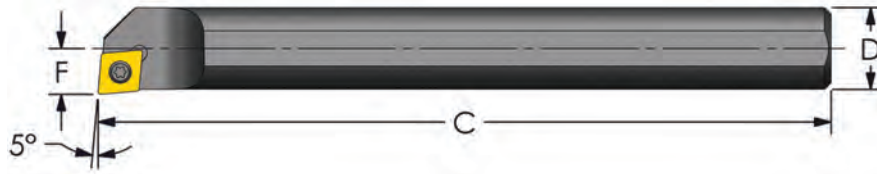

4:1 Ratio

Positive 80° Diamond (-5° Lead)

Coolant Thru

Designation	D Dia.	C OAL	F	Min Bore	Insert	Insert Screw	Key	Price	
A04G SCLDR/L1.5 *	.250	3.5	.172	.312	CDGW 1.510	MTS-184	T-6	\$72.00	
A05G SCLPR/L1.8 *	.312	3.5	.219	.395	CPMT 1.81.20.5	MTS-224	T-7	\$72.00	
A06K SCLPR/L2	.375	5	.250	.460		MTS-255	T-7	\$78.00	
A08M SCLPR/L2	.500	6	.312	.600		CPMT 21.51	MTS-255	T-7	\$85.00
A10Q SCLPR/L2	.625	7	.406	.760			MTS-255	T-7	\$105.00
A08M SCLPR/L3	.500	6	.344	.625	CPMT 32.51	MTS-35	T-15	\$85.00	
A10Q SCLPR/L3	.625	7	.406	.760		MTS-35	T-15	\$105.00	
A12Q SCLPR/L3	.750	7	.500	.920		MTS-35	T-15	\$123.00	
A16R SCLPR/L3	1.000	8	.625	1.185		MTS-35	T-15	\$162.00	
A06K SCLCR/L2	.375	5	.250	.460	CCMT 21.51	MTS-255	T-7	\$78.00	
A08M SCLCR/L2	.500	6	.312	.600		MTS-255	T-7	\$85.00	
A10Q SCLCR/L2	.625	7	.406	.760		MTS-255	T-7	\$105.00	
A08M SCLCR/L3	.500	6	.344	.625	CCMT 32.51	MTS-35	T-15	\$85.00	
A10Q SCLCR/L3	.625	7	.406	.760		MTS-35	T-15	\$105.00	
A12Q SCLCR/L3	.750	7	.500	.920		MTS-35	T-15	\$123.00	
A16R SCLCR/L3	1.000	8	.625	1.185		MTS-35	T-15	\$162.00	
A20U SCLCR/L3	1.250	14	.765	1.465	CCMT 432	MTS-35	T-15	\$232.00	
A20U SCLCR/L4	1.250	14	.765	1.465		MTS-4	T-20	\$254.00	
A24U SCLCR/L4	1.500	14	.890	1.730		MTS-4	T-20	\$287.00	

New

Also available in: Carbide pg: 49,50 Heavy Metal pg: 68 Modular pg: 74 Chatter-Free pg: 89, 92, 102

Minimum Clearance

Coolant Thru

Designation	D Dia.	C OAL	F	Min Bore	Insert	Insert Screw	Key	Price
A04G SCLDR/L1.5-138 *	.250	3.5	.138	.275	CDGW 1.510	MTS-184	T-6	\$72.00
A05G SCLPR/L1.8-167 *	.312	3.5	.167	.340	CPMT 1.81.20.5	MTS-224	T-7	\$72.00
A06K SCLPR/L2-203	.375	5	.203	.410	CPMT 21.51	MTS-255	T-7	\$78.00
A08M SCLPR/L2-281	.500	6	.281	.560		MTS-255	T-7	\$85.00
A06K SCLCR/L2-203	.375	5	.203	.410	CCMT 21.51	MTS-255	T-7	\$78.00
A08M SCLCR/L2-281	.500	6	.281	.560		MTS-255	T-7	\$85.00

Minimum Clearance Bars are intended for light machining with minimum bore clearance. Max depth of cut .015" - .020"
 *bars .312 and smaller do not have flats



Hardware
pg: 186



Inserts
pg: 167

Proudly Made in Flushing, MI USA

B

BORING

Steel Boring Bars (Positive)

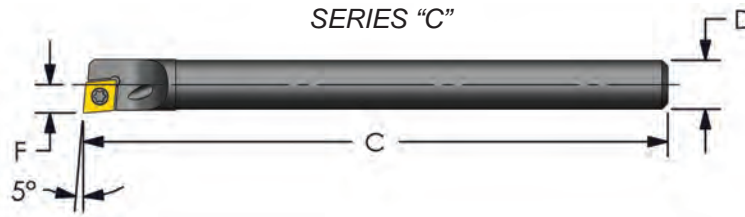

4:1 Ratio

Positive 80° Diamond (-5° Lead)

Coolant Thru

Designation	D Dia.	C OAL	F	Min Bore	Insert	Insert Screw	Key	Price
CSUD-180/187-2 1/2-5R *	.187	2.5	.104	.208	CDHB 1.20.60.5	MTS-183	T-6	\$79.00
CSUD-187-2 1/2-5R *	.187	2.5	.116	.230		MTS-183	T-6	\$79.00
CSUD-250-3-5R *	.250	3	.145	.285		MTS-184	T-6	\$79.00

Also available in: **Carbide pg: 51**

*bars do not have flats

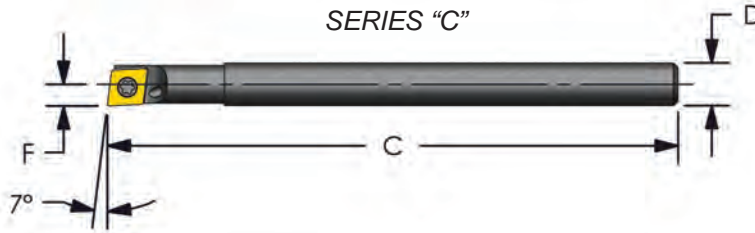

4:1 Ratio

Positive 80° Diamond (-7° Lead)

Coolant Thru

Designation	D Dia.	C OAL	F	Min Bore	Insert	Insert Screw	Key	Price
CSUD-165/187-2 1/2-7R *	.187	2.5	.095	.180	CDHB 1.20.60.5	MTS-183	T-6	\$79.00

Also available in: **Carbide pg: 51**

*bars do not have flats

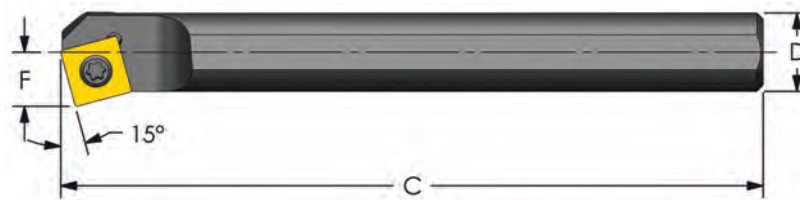

4:1 Ratio

Positive Square (15° Lead)

No Coolant

Designation	D Dia.	C OAL	F	Min Bore	Insert	Insert Screw	Key	Price
S06K SSKCR2	.375	5	.250	.460	SCMT 21.51	MTS-255	T-7	\$65.00
S08M SSKCR3	.500	6	.344	.625	SCMT 32.51	MTS-35	T-15	\$73.00
S10Q SSKCR3	.625	7	.406	.760		MTS-35	T-15	\$91.00
S12Q SSKCR3	.750	7	.500	.920		MTS-35	T-15	\$105.00
S16R SSKCR4	1.000	8	.625	1.185	SCMT 432	MTS-4	T-20	\$144.00

Also available in: **Carbide pg: 51** **Modular pg: 75**

B

BORING

Steel Boring Bars (Positive)

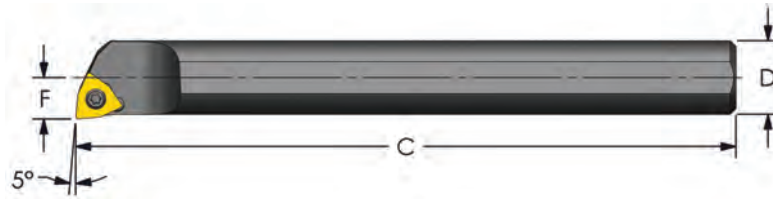

4:1 Ratio

Positive Trigon (-5° Lead)

No Coolant

Designation	D Dia.	C OAL	F	Min Bore	Insert	Insert Screw	Key	Price
S03G SWLCR1.2 *	.187	3.5	.102	.205	WCMT 1.210.5	MTS-183	T-6	\$59.00
S04G SWLCR1.2 *	.250	3.5	.172	.312		MTS-184	T-6	\$59.00
S05G SWLCR1.5 *	.312	3.5	.219	.395	WCMT 1.51.50.5	MTS-2	T-6	\$59.00
S06K SWLCR/L2	.375	5	.250	.460	WCMT 21.51	MTS-255	T-7	\$59.00
S08M SWLCR/L2	.500	6	.312	.600		MTS-255	T-7	\$66.00
S10Q SWLCR/L2	.625	7	.406	.760		MTS-255	T-7	\$82.00
S10Q SWLCR/L3	.625	7	.406	.760	WCMT 32.51	MTS-35	T-15	\$82.00
S12Q SWLCR/L3	.750	7	.500	.920		MTS-35	T-15	\$94.00
S16R SWLCR/L3	1.000	8	.625	1.185		MTS-35	T-15	\$130.00

Also available in: **Carbide pg: 52** **Heavy Metal pg: 69**

Minimum Clearance

No Coolant

Designation	D Dia.	C OAL	F	Min Bore	Insert	Insert Screw	Key	Price
S04G SWLCR1.2-138 *	.250	3.5	.138	.275	WCMT 1.210.5	MTS-184	T-6	\$59.00
S05G SWLCR1.5-167 *	.312	3.5	.167	.342	WCMT 1.51.50.5	MTS-2	T-6	\$59.00
S06K SWLCR/L2-203	.375	5	.203	.410	WCMT 21.51	MTS-255	T-7	\$59.00
S08M SWLCR/L2-281	.500	6	.281	.560		MTS-255	T-7	\$66.00

Minimum Clearance Bars are intended for light machining with minimum bore clearance. Max depth of cut .015" - .020"
 * bars .312 and smaller do not have flats

Positive Trigon (-5° Lead)

4:1 Ratio

Coolant Thru

Designation	D Dia.	C OAL	F	Min Bore	Insert	Insert Screw	Key	Price
A06K SWLCR/L2	.375	5	.250	.460	WCMT 21.51	MTS-255	T-7	\$78.00
A08M SWLCR/L2	.500	6	.312	.600		MTS-255	T-7	\$85.00
A10Q SWLCR/L2	.625	7	.406	.760		MTS-255	T-7	\$105.00
A10Q SWLCR/L3	.625	7	.406	.760	WCMT 32.51	MTS-35	T-15	\$105.00
A12Q SWLCR/L3	.750	7	.500	.920		MTS-35	T-15	\$123.00
A16R SWLCR/L3	1.000	8	.625	1.185		MTS-35	T-15	\$162.00

Also available in: **Carbide pg: 53** **Heavy Metal pg: 69** **Modular pg: 75**

Minimum Clearance

Coolant Thru

Designation	D Dia.	C OAL	F	Min Bore	Insert	Insert Screw	Key	Price
A06K SWLCR/L2-203	.375	5	.203	.410	WCMT 21.51	MTS-255	T-7	\$78.00
A08M SWLCR/L2-281	.500	6	.281	.560		MTS-255	T-7	\$85.00

Minimum Clearance Bars are intended for light machining with minimum bore clearance. Max depth of cut .015" - .020"
 * bars .312 and smaller do not have flats



Hardware
pg: 186



Inserts
pg: 167

Prices are subject to change without notice.

B
BORING

Steel Boring Bars (Positive)

SERIES "G, Q, S"

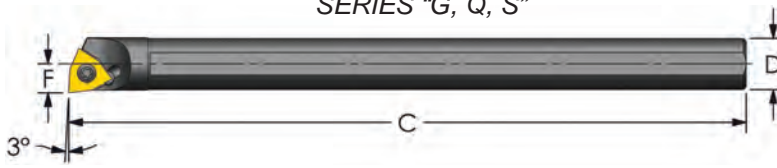

Positive Trigon (-3° Lead)

4:1 Ratio
Coolant Thru

Designation	D Dia.	C OAL	F	Min Bore	Insert	Insert Screw	Key	Price
GSUDW-187-4-3R/L	.187	4	.126	.260	WPGT 1.511	MTS-184	T-6	\$73.00
GSUDW-250-4-3R/L	.250	4	.143	.285		MTS-184	T-6	\$73.00
GSUDW-312-4-3R/L	.312	4	.174	.347		MTS-184	T-6	\$73.00
QSUDW-375-5-3R/L	.375	5	.211	.415	WPGT 21.50	MTS-255	T-7	\$79.00
QSUDW-500-6-3R/L	.500	6	.273	.540		MTS-255	T-7	\$86.00
SSUDW-625-7-3R/L	.625	7	.345	.675	WPMT 32.51	MTS-35	T-15	\$86.00
SSUDW-750-8-3R/L	.750	8	.407	.800		MTS-35	T-15	\$93.00

Also available in: **Carbide pg: 52**

SERIES "F, Q, S"



Positive Triangle (0° Lead)

4:1 Ratio
Coolant Thru

Designation	D Dia.	C OAL	F	Min Bore	Insert	Insert Screw	Key	Price
FSUD-250-4-0R *	.250	4	.156	.300	TDHB 1.280.750.5	MTS-224	T-7	\$73.00
QSUD-375-5-0R *	.375	5	.221	.438	TPCB 220.5	ETS 4-40	T-10	\$79.00
SSUD-500-6-0R *	.500	6	.339	.668	TD 320.5	ETS 4-40	T-10	\$79.00
SSUD-625-7-0R *	.625	7	.393	.731		ETS 4-40	T-10	\$86.00

*bars do not have flats

SERIES "F, Q, S"



Positive Triangle (-5° Lead)

4:1 Ratio
Coolant Thru

Designation	D Dia.	C OAL	F	Min Bore	Insert	Insert Screw	Key	Price
FSUD-187-3 1/2-5R *	.187	3.5	.123	.275	TDHB 1.280.750.5	MTS-224	T-7	\$73.00
FSUD-250-4-5R *	.250	4	.156	.300		MTS-224	T-7	\$73.00
FSUD-312-4-5R *	.312	4	.187	.360		MTS-224	T-7	\$73.00
QSUD-375-5-5R/L *	.375	5	.221	.438	TPCB 220.5	ETS 4-40	T-10	\$79.00
QSUD-500-6-5R *	.500	6	.296	.563		ETS 4-40	T-10	\$86.00
SSUD-500-6-5R *	.500	6	.339	.668	TD 320.5	ETS 4-40	T-10	\$79.00
SSUD-625-4-5R *	.625	4	.393	.731		ETS 4-40	T-10	\$79.00
SSUD-625-7-5R *	.625	7	.393	.731		ETS 4-40	T-10	\$86.00
SSUD-750-4-5R *	.750	4	.460	.855		ETS 4-40	T-10	\$86.00
SSUD-750-8-5R *	.750	8	.460	.855		ETS 4-40	T-10	\$93.00
SSUD-1000-10-5R *	1.000	10	.585	1.105		ETS 4-40	T-10	\$133.00
SSUD-1250-12-5R *	1.250	12	.710	1.355		ETS 4-40	T-10	\$174.00

Also available in: **Carbide pg: 58**

*bars do not have flats

B

BORING

Steel Boring Bars (Positive)

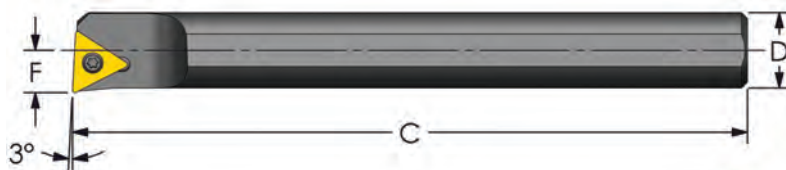
**4:1 Ratio****No Coolant**

Positive Triangle (-3° Lead)

Designation	D Dia.	C OAL	F	Min Bore	Insert	Insert Screw	Key	Price
S04G STUCR/L1.2 *	.250	3.5	.172	.312	TCMT 1.21.20.5	MTS-184	T-6	\$53.00
S05G STUCR/L1.2 *	.312	3.5	.219	.395		MTS-184	T-6	\$53.00
S06K STUCR/L2	.375	5	.250	.460	TCMT 21.51	MTS-255	T-7	\$59.00
S08M STUCR/L2	.500	6	.312	.600		MTS-255	T-7	\$66.00
S10Q STUCR/L2	.625	7	.406	.760		MTS-255	T-7	\$82.00
S12Q STUCR/L3	.750	7	.500	.920	TCMT 32.51	MTS-35	T-15	\$94.00
S16R STUCR/L3	1.000	8	.625	1.185		MTS-35	T-15	\$130.00
S06K STUPR/L2	.375	5	.250	.460	TPMT 21.51	MTS-255	T-7	\$59.00
S08M STUPR/L2	.500	6	.312	.600		MTS-255	T-7	\$66.00
S10Q STUPR/L2	.625	7	.406	.760		MTS-255	T-7	\$82.00
S12Q STUPR/L3	.750	7	.500	.920	TPMT 32.51	MTS-35	T-15	\$94.00
S16R STUPR/L3	1.000	8	.625	1.185		MTS-35	T-15	\$130.00

Also available in: **Carbide pg: 54** **Heavy Metal pg: 70**

Minimum Clearance

No Coolant

Designation	D Dia.	C OAL	F	Min Bore	Insert	Insert Screw	Key	Price
S04G STUCR/L1.2-138 *	.250	3.5	.138	.275	TCMT 1.21.20.5	MTS-184	T-6	\$53.00
S05G STUCR/L1.2-167 *	.312	3.5	.167	.340		MTS-184	T-6	\$53.00
S06K STUCR/L2-203	.375	5	.203	.410	TCMT 21.51	MTS-255	T-7	\$59.00
S08M STUCR/L2-281	.500	6	.281	.560		MTS-255	T-7	\$66.00
S06K STUPR/L2-203	.375	5	.203	.410	TPMT 21.51	MTS-255	T-7	\$59.00
S08M STUPR/L2-281	.500	6	.281	.560		MTS-255	T-7	\$66.00

Minimum Clearance Bars are intended for light machining with minimum bore clearance. Max depth of cut .015" - .020"
 * bars .312 and smaller do not have flats



ULTRA-DEX

Hardware
pg: 186

Inserts
pg: 167

Proudly Made in Flushing, MI USA
B**BORING**

Steel Boring Bars (Positive)

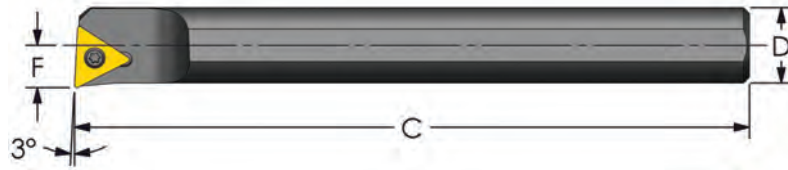

4:1 Ratio

Positive Triangle (-3° Lead)

Coolant Thru

Designation	D Dia.	C OAL	F	Min Bore	Insert	Insert Screw	Key	Price
A04G STUCR/L1.2 *	.250	3.5	.172	.312	TCMT 1.21.20.5	MTS-184	T-6	\$72.00
A05G STUCR/L1.2 *	.312	3.5	.219	.395		MTS-184	T-6	\$72.00
A06K STUCR/L2	.375	5	.250	.460	TCMT 21.51	MTS-255	T-7	\$78.00
A08M STUCR/L2	.500	6	.312	.600		MTS-255	T-7	\$85.00
A10Q STUCR/L2	.625	7	.406	.760		MTS-255	T-7	\$105.00
A12Q STUCR/L3	.750	7	.500	.920	TCMT 32.51	MTS-35	T-15	\$123.00
A16R STUCR/L3	1.000	8	.625	1.185		MTS-35	T-15	\$162.00
A06K STUPR/L2	.375	5	.250	.460	TPMT 21.51	MTS-255	T-7	\$78.00
A08M STUPR/L2	.500	6	.312	.600		MTS-255	T-7	\$85.00
A10Q STUPR/L2	.625	7	.406	.760		MTS-255	T-7	\$105.00
A12Q STUPR/L3	.750	7	.500	.920	TPMT 32.51	MTS-35	T-15	\$123.00
A16R STUPR/L3	1.000	8	.625	1.185		MTS-35	T-15	\$162.00

Also available in: Carbide pg: 60 Heavy Metal pg: 75 Modular pg: 81 Chatter-Free pg: 100, 115

Minimum Clearance

Coolant Thru

Designation	D Dia.	C OAL	F	Min Bore	Insert	Insert Screw	Key	Price
A04G STUCR/L1.2-138 *	.250	3.5	.138	.275	TCMT 1.21.20.5	MTS-184	T-6	\$72.00
A05G STUCR/L1.2-167 *	.312	3.5	.167	.340		MTS-184	T-6	\$72.00
A06K STUCR/L2-203	.375	5	.203	.410	TCMT 21.51	MTS-255	T-7	\$78.00
A08M STUCR/L2-281	.500	6	.281	.560		MTS-255	T-7	\$85.00
A06K STUPR/L2-203	.375	5	.203	.410	TPMT 21.51	MTS-255	T-7	\$78.00
A08M STUPR/L2-281	.500	6	.281	.560		MTS-255	T-7	\$85.00

Minimum Clearance Bars are intended for light machining with minimum bore clearance. Max depth of cut .015" - .020"
 * bars .312 and smaller do not have flats



B

BORING

Steel Boring Bars (Positive)

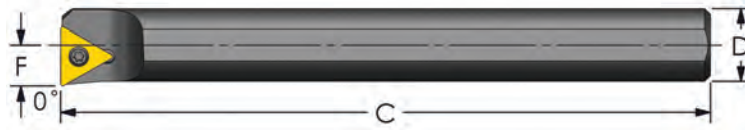

4:1 Ratio

No Coolant

Positive Triangle (0° Lead)

Designation	D Dia.	C OAL	F	Min Bore	Insert	Insert Screw	Key	Price
S04G STFCR/L1.2 *	.250	3.5	.172	.312	TCMT 1.21.20.5	MTS-184	T-6	\$53.00
S05G STFCR/L1.2 *	.312	3.5	.219	.395		MTS-184	T-6	\$53.00
S06K STFCR2	.375	5	.250	.460	TCMT 21.51	MTS-255	T-7	\$59.00
S08M STFCR2	.500	6	.312	.600		MTS-255	T-7	\$66.00
S10Q STFCR2	.625	7	.406	.760		MTS-255	T-7	\$82.00
S12Q STFCR3	.750	7	.500	.920	TCMT 32.51	MTS-35	T-15	\$94.00
S16R STFCR3	1.000	8	.625	1.185		MTS-35	T-15	\$130.00
S06K STFPR2	.375	5	.250	.460	TPMT 21.51	MTS-255	T-7	\$59.00
S08M STFPR2	.500	6	.312	.600		MTS-255	T-7	\$66.00
S10Q STFPR2	.625	7	.406	.760		MTS-255	T-7	\$82.00
S12Q STFPR3	.750	7	.500	.920	TPMT 32.51	MTS-35	T-15	\$94.00
S16R STFPR3	1.000	8	.625	1.185		MTS-35	T-15	\$130.00

Also available in: **Carbide pg: 56**

Minimum Clearance

No Coolant

Designation	D Dia.	C OAL	F	Min Bore	Insert	Insert Screw	Key	Price
S04G STFCR/L1.2-138 *	.250	3.5	.138	.275	TCMT 1.21.20.5	MTS-184	T-6	\$53.00
S05G STFCR/L1.2-167 *	.312	3.5	.167	.340		MTS-184	T-6	\$53.00
S06K STFCR2-203	.375	5	.203	.410	TCMT 21.51	MTS-255	T-7	\$59.00
S08M STFCR2-281	.500	6	.281	.560		MTS-255	T-7	\$66.00
S06K STFPR2-203	.375	5	.203	.410	TPMT 21.51	MTS-255	T-7	\$59.00
S08M STFPR2-281	.500	6	.281	.560		MTS-255	T-7	\$66.00

Minimum Clearance Bars are intended for light machining with minimum bore clearance. Max depth of cut .015" - .020"
 * bars .312 and smaller do not have flats

SAME DAY SHIPPING!

On orders placed before 3:00pm EST
 SEE PAGE 190 for more details...



Hardware
pg: 186



Inserts
pg: 167

Proudly Made in Flushing, MI USA

B
BORING

Steel Boring Bars (Positive)

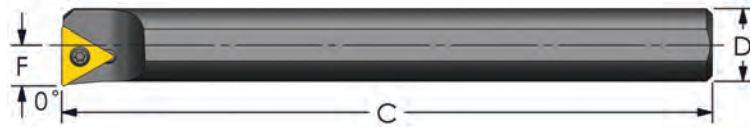

4:1 Ratio

Positive Triangle (0° Lead)

Coolant Thru

Designation	D Dia.	C OAL	F	Min Bore	Insert	Insert Screw	Key	Price
A06K STFCR2	.375	5	.250	.460	TCMT 21.51	MTS-255	T-7	\$78.00
A08M STFCR2	.500	6	.312	.600		MTS-255	T-7	\$85.00
A10Q STFCR2	.625	7	.406	.760		MTS-255	T-7	\$105.00
A12Q STFCR3	.750	7	.500	.920	TCMT 32.51	MTS-35	T-15	\$123.00
A16R STFCR3	1.000	8	.625	1.185		MTS-35	T-15	\$162.00
A06K STFPR2	.375	5	.250	.460	TPMT 21.51	MTS-255	T-7	\$78.00
A08M STFPR2	.500	6	.312	.600		MTS-255	T-7	\$85.00
A10Q STFPR2	.625	7	.406	.760		MTS-255	T-7	\$105.00
A12Q STFPR3	.750	7	.500	.920	TPMT 32.51	MTS-35	T-15	\$123.00
A16R STFPR3	1.000	8	.625	1.185		MTS-35	T-15	\$162.00

Also available in: Carbide pg: 57 Modular pg: 75 Chatter-Free pg: 93, 102

Minimum Clearance

Coolant Thru

Designation	D Dia.	C OAL	F	Min Bore	Insert	Insert Screw	Key	Price
A06K STFCR2-203	.375	5	.203	.410	TCMT 21.51	MTS-255	T-7	\$78.00
A08M STFCR2-281	.500	6	.281	.560		MTS-255	T-7	\$85.00
A06K STFPR2-203	.375	5	.203	.410	TPMT 21.51	MTS-255	T-7	\$78.00
A08M STFPR2-281	.500	6	.281	.560		MTS-255	T-7	\$85.00

Minimum Clearance Bars are intended for light machining with minimum bore clearance. Max depth of cut .015" - .020"
 * bars .312 and smaller do not have flats

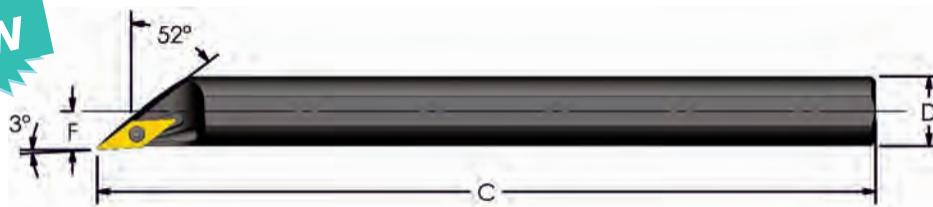

4:1 Ratio

Positive 35° Diamond (-52° Lead) Profiling

Coolant Thru

Designation	D Dia.	C OAL	F	Min Bore	Insert	Insert Screw	Key	Price
A06K SVJBR2	.375	5	.223	.445	VBMT 21.51	MTS-2.5L	T-7	\$78.00
A08M SVJBR2	.500	6	.285	.570		MTS-2.5L	T-7	\$85.00
A10Q SVJBR2	.625	7	.348	.700		MTS-2.5L	T-7	\$103.00
A12Q SVJBR3	.750	7	.421	.840	VBMT 331	MTS-3.5L	T-15	\$120.00

Also available in: Carbide pg: 60 Modular pg: 77

B
BORING

Steel Boring Bars (Positive)

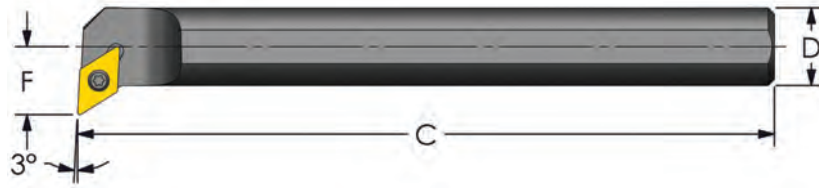

4:1 Ratio

No Coolant

Positive 55° Diamond (-3° Lead) Profiling

Designation	D Dia.	C OAL	F	Min Bore	Insert	Insert Screw	Key	Price
S06K SDUCR/L2	.375	5	.375	.585	DCMT 21.51	MTS-255	T-7	\$72.00
S08M SDUCR/L2	.500	6	.437	.720		MTS-255	T-7	\$82.00
S10Q SDUCR/L2	.625	7	.500	.850		MTS-255	T-7	\$100.00
S12Q SDUCR/L3	.750	7	.625	1.050	DCMT 32.51	MTS-35	T-15	\$113.00
S16R SDUCR/L3	1.000	8	.750	1.310		MTS-35	T-15	\$153.00
S12Q SDUPR/L3	.750	7	.625	1.050	DPMT 32.51	MTS-35	T-15	\$113.00
S16R SDUPR/L3	1.000	8	.750	1.310		MTS-35	T-15	\$153.00

Also available in: **Carbide pg: 58**

Positive 55° Diamond (-3° Lead) Profiling

Coolant Thru

Designation	D Dia.	C OAL	F	Min Bore	Insert	Insert Screw	Key	Price
A06K SDUCR/L2	.375	5	.375	.585	DCMT 21.51	MTS-255	T-7	\$85.00
A08M SDUCR/L2	.500	6	.437	.720		MTS-255	T-7	\$93.00
A10Q SDUCR/L2	.625	7	.500	.850		MTS-255	T-7	\$113.00
A12Q SDUCR/L3	.750	7	.625	1.050	DCMT 32.51	MTS-35	T-15	\$131.00
A16R SDUCR/L3	1.000	8	.750	1.310		MTS-35	T-15	\$171.00
A12Q SDUPR/L3	.750	7	.625	1.050	DPMT 32.51	MTS-35	T-15	\$131.00
A16R SDUPR/L3	1.000	8	.750	1.310		MTS-35	T-15	\$171.00

Also available in: **Carbide pg: 59** **Modular pg: 81** **Chatter-Free pg: 89, 93, 103**

B

BORING



Visit ultradexusa.com

for further information including videos and additional images of our products

Be the first to know when our **NEWEST** products are released!

CHECK FOR MONTHLY SPECIALS!





Hardware
pg: 186



Inserts
pg: 169

Proudly Made in Flushing, MI USA

Steel Boring Bars (Positive)

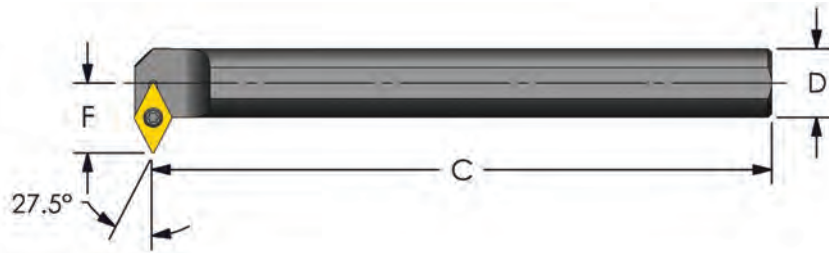

4:1 Ratio

Positive 55° Diamond (27.5° Lead) Profiling

No Coolant

Designation	D Dia.	C OAL	F	Min Bore	Insert	Insert Screw	Key	Price
S08M SDNCR2	.500	6.00	.508	.780	DCMT 21.51	MTS-255	T-7	\$82.00
S10Q SDNCR2	.625	6.86	.562	.920				\$100.00
S12Q SDNCR3	.750	6.80	.765	1.190	DCMT 32.51	MTS-35	T-15	\$113.00
S16R SDNCR3	1.00	7.80	.890	1.450				\$153.00

Also available in: Carbide pg: 65 Modular pg: 82

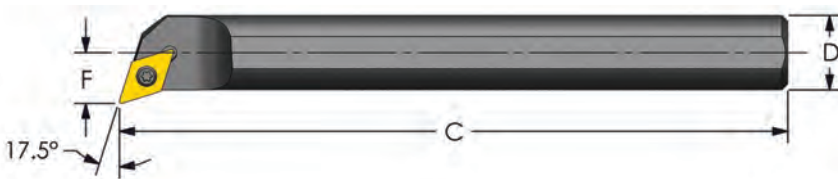

4:1 Ratio

Positive 55° Diamond (-17.5° Lead) Profiling

No Coolant

Designation	D Dia.	C OAL	F	Min Bore	Insert	Insert Screw	Key	Price
S06K SDQCR2	.375	5	.281	.490	DCMT 21.51	MTS-255	T-7	\$72.00
S08M SDQCR2	.500	6	.341	.620		MTS-255	T-7	\$82.00
S10Q SDQCR2	.625	7	.406	.760		MTS-255	T-7	\$100.00

Also available in: Carbide pg: 65

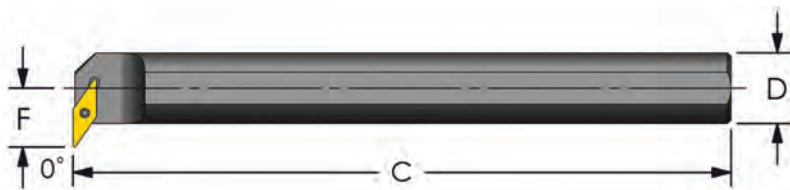

4:1 Ratio

Positive 35° Diamond (0° Lead) Profiling

No Coolant

Designation	D Dia.	C OAL	F	Min Bore	Insert	Insert Screw	Key	Price
S10Q SVFBR2	.625	7	.500	.850	VBMT 21.51	MTS-2.5L	T-7	\$100.00
S12Q SVFBR2	.750	7	.625	1.050		MTS-2.5L	T-7	\$113.00
S16X SVFBR3	1.000	9	.750	1.310	VBMT 331	MTS-3.5L	T-15	\$153.00

B

BORING

Steel Boring Bars (Positive)

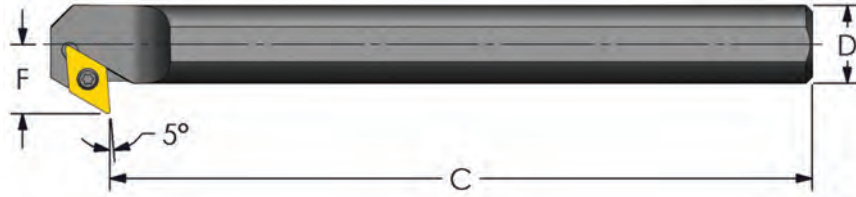

Positive 55° Diamond (5° Lead) Back Facing

4:1 Ratio

No Coolant

Designation	D Dia.	C OAL	F	Min Bore	Insert	Insert Screw	Key	Price
S06J SDXCR/L2	.375	4.5	.375	.585	DCMT 21.51	MTS-255	T-7	\$72.00
S08M SDXCR/L2	.500	6	.437	.720		MTS-255	T-7	\$82.00
S10M SDXCR/L2	.625	6	.500	.850		MTS-255	T-7	\$100.00
S12Q SDXCR/L3	.750	7	.625	1.050	DCMT 32.51	MTS-35	T-15	\$113.00
S16X SDXCR/L3	1.000	9	.750	1.310		MTS-35	T-15	\$153.00

Also available in: **Carbide pg: 60**

Positive 55° Diamond (5° Lead) Back Facing

Coolant Thru

Designation	D Dia.	C OAL	F	Min Bore	Insert	Insert Screw	Key	Price
A06J SDXCR/L2	.375	4.5	.375	.585	DCMT 21.51	MTS-255	T-7	\$85.00
A08M SDXCR/L2	.500	6	.437	.720		MTS-255	T-7	\$93.00
A10M SDXCR/L2	.625	6	.500	.850		MTS-255	T-7	\$113.00
A12Q SDXCR/L3	.750	7	.625	1.050	DCMT 32.51	MTS-35	T-15	\$131.00
A16X SDXCR/L3	1.000	9	.750	1.310		MTS-35	T-15	\$171.00

Also available in: **Carbide pg: 60** **Modular pg: 77** **Chatter-Free pg: 103**

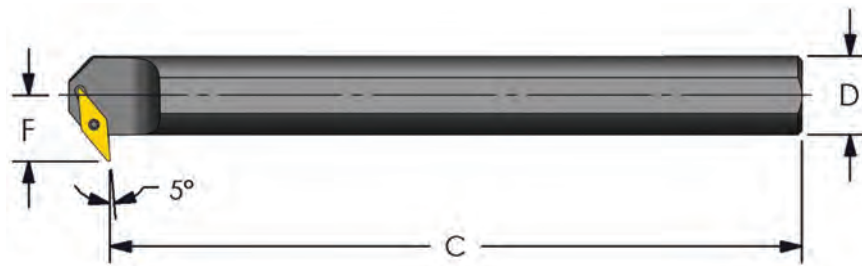

Positive 35° Diamond (5° Lead) Back Facing

4:1 Ratio

No Coolant

Designation	D Dia.	C OAL	F	Min Bore	Insert	Insert Screw	Key	Price
S12Q SVXBR2	.750	6.6	.625	1.050	VBMT 21.51	MTS-2.5L	T-7	\$113.00
S16X SVXBR3	1.000	9	.875	1.435	VBMT 331	MTS-3.5L	T-15	\$153.00

B

BORING



Hardware
pg: 186



Inserts
pg: 167

Proudly Made in Flushing, MI USA

Steel Boring Bars (Negative)

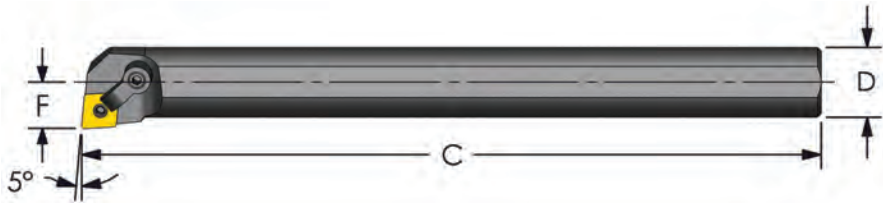

4:1 Ratio

No Coolant

Negative 80° Diamond (-5° Lead)

Designation	D Dia.	C OAL	F	Min Bore	Insert	Shim Seat	Clamp	Clamp Screw	Lock Pin	Price
S12R MCLNR/L3	.750	8	.500	.920	CNMG 322	--	CL-7	XNS-36	NL-33	\$118.00
S16S MCLNR/L3	1.000	10	.640	1.200		--	CL-7	XNS-36	NL-33	\$154.00
S16S MCLNR/L4	1.000	10	.640	1.200	CNMG 432	--	CL-20	XNS-47	NL-44	\$154.00
S20S MCLNR/L4	1.250	10	.765	1.470		ICSN-433	CL-20	XNS-47	NL-46	\$178.00
S20U MCLNR/L4	1.250	14	.765	1.470		ICSN-433	CL-20	XNS-47	NL-46	\$228.00
S24U MCLNR/L4	1.500	14	.890	1.730		ICSN-433	CL-20	XNS-47	NL-46	\$259.00
S32V MCLNR/L4	2.000	16	1.281	2.400		ICSN-433	CL-20	XNS-47	NL-46	\$292.00

Negative 80° Diamond (-5° Lead)

Coolant Thru

Designation	D Dia.	C OAL	F	Min Bore	Insert	Shim Seat	Clamp	Clamp Screw	Lock Pin	Price
A12R MCLNR/L3	.750	8	.500	.920	CNMG 322	--	CL-7	XNS-36	NL-33	\$153.00
A16S MCLNR/L3	1.000	10	.640	1.200		--	CL-7	XNS-36	NL-33	\$194.00
A16S MCLNR/L4	1.000	10	.640	1.200	CNMG 432	--	CL-20	XNS-47	NL-44	\$194.00
A20S MCLNR/L4	1.250	10	.765	1.470		ICSN-433	CL-20	XNS-47	NL-46	\$218.00
A20U MCLNR/L4	1.250	14	.765	1.470		ICSN-433	CL-20	XNS-47	NL-46	\$284.00
A24U MCLNR/L4	1.500	14	.890	1.730		ICSN-433	CL-20	XNS-47	NL-46	\$322.00
A32V MCLNR/L4	2.000	16	1.281	2.400		ICSN-433	CL-20	XNS-47	NL-46	\$360.00

Also available in: **Carbide pg: 61** **Modular pg: 78** **Chatter-Free pg: 94**

B

BORING

DON'T THROW IT

Send Us Your Damaged Tooling for Repair

See **pg. 188**
For More
Details

Steel Boring Bars (Negative)

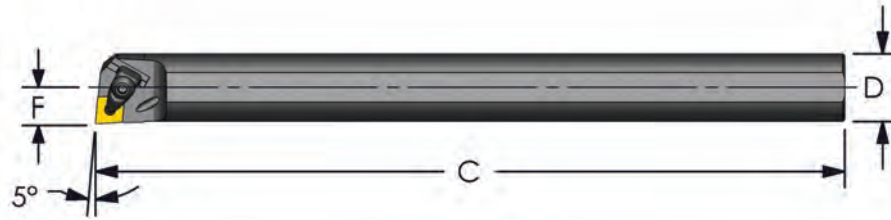

4:1 Ratio

Negative 80° Diamond (-5° Lead)

Coolant Thru

Designation	D Dia.	C OAL	F	Min Bore	Insert	Shim	Shim Screw	Clamp Assy.	Price
A16S DCLNR4	1.000	10	.640	1.200	CNMG 432	--	--	PB4-CA	\$287.00
A20U DCLNR4	1.250	14	.765	1.470		ICSN 433	PB4-SS	PB4-CA	\$311.00
A24U DCLNR4	1.500	14	.890	1.730		ICSN 433	PB4-SS	PB4-CA	\$408.00

Also available in: Carbide pg: 61 Modular pg: 82 Chatter-Free pg: 104

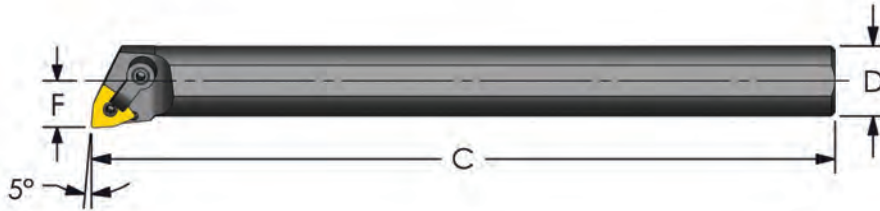

4:1 Ratio

Negative Trigon (-5° Lead)

No Coolant

Designation	D Dia.	C OAL	F	Min Bore	Insert	Shim Seat	Clamp	Clamp Screw	Lock Pin	Price
S12R MWLNR/L3	.750	8	.500	.920	WNMG 332	--	CL-7	XNS-36	NL-33L	\$118.00
S16S MWLNR/L3	1.000	10	.640	1.200		--	CL-7	XNS-36	NL-33L	\$154.00
S16S MWLNR/L4	1.000	10	.640	1.200	WNMG 432	--	CL-20	XNS-47	NL-44	\$154.00
S20S MWLNR/L4	1.250	10	.765	1.470		IWSN-433	CL-20	XNS-47	NL-46	\$178.00
S20U MWLNR/L4	1.250	14	.765	1.470		IWSN-433	CL-20	XNS-47	NL-46	\$216.00
S24U MWLNR/L4	1.500	14	.890	1.730		IWSN-433	CL-20	XNS-47	NL-46	\$259.00
S32V MWLNR/L4	2.000	16	1.281	2.400		IWSN-433	CL-20	XNS-47	NL-46	\$292.00

Negative Trigon (-5° Lead)

Coolant Thru

Designation	D Dia.	C OAL	F	Min Bore	Insert	Shim Seat	Clamp	Clamp Screw	Lock Pin	Price
A12R MWLNR/L3	.750	8	.500	.920	WNMG 332	--	CL-7	XNS-36	NL-33L	\$153.00
A16S MWLNR/L3	1.000	10	.640	1.200		--	CL-7	XNS-36	NL-33L	\$194.00
A16S MWLNR/L4	1.000	10	.640	1.200	WNMG 432	--	CL-20	XNS-47	NL-44	\$194.00
A20S MWLNR/L4	1.250	10	.765	1.470		IWSN-433	CL-20	XNS-47	NL-46	\$218.00
A20U MWLNR/L4	1.250	14	.765	1.470		IWSN-433	CL-20	XNS-47	NL-46	\$284.00
A24U MWLNR/L4	1.500	14	.890	1.730		IWSN-433	CL-20	XNS-47	NL-46	\$322.00
A32V MWLNR/L4	2.000	16	1.281	2.400		IWSN-433	CL-20	XNS-47	NL-46	\$360.00

Also available in: Carbide pg: 62 Modular pg: 79 Chatter Free pg: 95



Hardware
pg: 186



Inserts
pg: 167

Proudly Made in Flushing, MI USA

B
BORING

Steel Boring Bars (Negative)

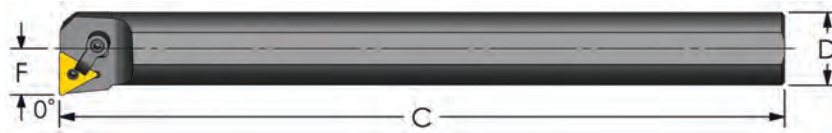

4:1 Ratio

Negative Triangle (0° Lead)

No Coolant

Designation	D Dia.	C OAL	F	Min Bore	Insert	Shim Seat	Clamp	Clamp Screw	Lock Pin	Price
S16S MTFNR3	1.000	10	.640	1.200	TNMG 332	--	CL-7	XNS-36	NL-33L	\$154.00
S20S MTFNR3	1.250	10	.765	1.470		ITSN-323	CL-7	XNS-36	NL-34L	\$178.00
S20U MTFNR3	1.250	14	.765	1.470	ITSN-323	CL-7	XNS-36	NL-34L	\$228.00	
S24U MTFNR4	1.500	14	.890	1.730	TNMG 432	ITSN-433	CL-20	XNS-47	NL-46	\$259.00

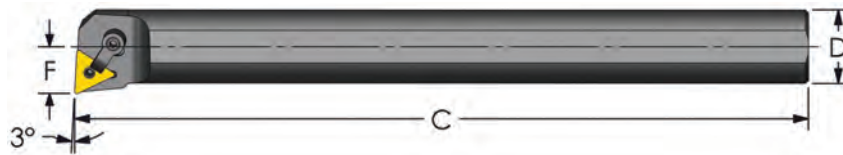

4:1 Ratio

Negative Triangle (-3° Lead)

No Coolant

Designation	D Dia.	C OAL	F	Min Bore	Insert	Shim Seat	Clamp	Clamp Screw	Lock Pin	Price
S16S MTUNR3	1.000	10	.640	1.200	TNMG 332	--	CL-7	XNS-36	NL-33L	\$154.00
S20S MTUNR3	1.250	10	.765	1.470		ITSN-323	CL-7	XNS-36	NL-34L	\$178.00
S20U MTUNR3	1.250	14	.765	1.470	ITSN-323	CL-7	XNS-36	NL-34L	\$228.00	
S24U MTUNR4	1.500	14	.890	1.730	TNMG 432	ITSN-433	CL-20	XNS-47	NL-46	\$259.00

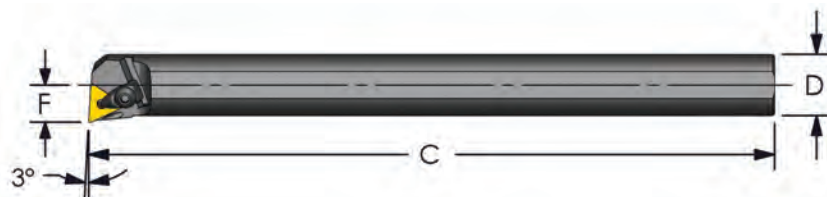

4:1 Ratio

Negative Triangle (-3° Lead)

Coolant Thru

Designation	D Dia.	C OAL	F	Min Bore	Insert	Shim	Shim Screw	Clamp Assy.	Price
A16S DTUNR4	1.000	10	.640	1.200	TNMG 432	--	--	PB4-CA	\$287.00
A20U DTUNR4	1.250	14	.765	1.470		ITSN-433	PB4-SS	PB4-CA	\$311.00
A24U DTUNR4	1.500	14	.890	1.730		ITSN-433	PB4-SS	PB4-CA	\$408.00

Also available in: Modular pg: 82 Chatter-Free pg: 104

B

BORING

Steel Boring Bars (Negative)

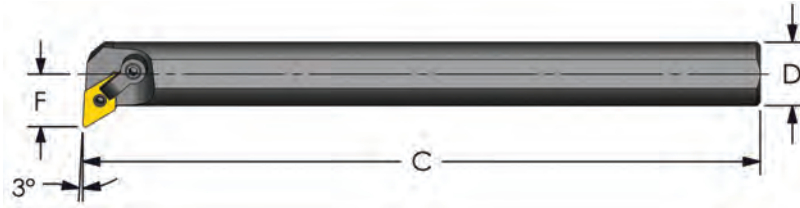

Negative 55° Diamond (-3° Lead) Profiling

4:1 Ratio
No Coolant

Designation	D Dia.	C OAL	F	Min Bore	Insert	Shim Seat	Clamp	Clamp Screw	Lock Pin	Price
S12R MDUNR/L3	.750	8	.625	1.050	DNMG 332	--	CL-7	XNS-36	NL-33L	\$142.00
S16S MDUNR/L3	1.000	10	.750	1.310		--	CL-7	XNS-36	NL-33L	\$182.00
S20T MDUNR/L3	1.250	12	1.000	1.700		IDSN-322	CL-7	XNS-36	NL-34L	\$260.00
S20T MDUNR/L4	1.250	12	1.000	1.700	DNMG 432	IDSN-433	CL-22	XNS-48	NL-46	\$260.00
S24U MDUNR/L4	1.500	14	1.125	1.960		IDSN-433	CL-22	XNS-48	NL-46	\$298.00

Negative 55° Diamond (-3° Lead) Profiling

4:1 Ratio
Coolant Thru

Designation	D Dia.	C OAL	F	Min Bore	Insert	Shim Seat	Clamp	Clamp Screw	Lock Pin	Price
A12R MDUNR/L3	.750	8	.625	1.050	DNMG 332	--	CL-7	XNS-36	NL-33L	\$164.00
A16S MDUNR/L3	1.000	10	.750	1.310		--	CL-7	XNS-36	NL-33L	\$204.00
A20T MDUNR/L3	1.250	12	1.000	1.700		IDSN-322	CL-7	XNS-36	NL-34L	\$290.00
A20T MDUNR/L4	1.250	12	1.000	1.700	DNMG 432	IDSN-433	CL-22	XNS-48	NL-46	\$290.00
A24U MDUNR/L4	1.500	14	1.125	1.960		IDSN-433	CL-22	XNS-48	NL-46	\$333.00

Also available in: Modular pg: 80 Chatter-Free pg: 96

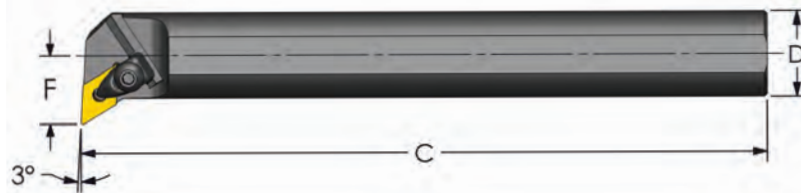

Negative 55° Diamond (-3° Lead)

4:1 Ratio
Coolant Thru

Designation	D Dia.	C OAL	F	Min Bore	Insert	Shim	Shim Screw	Clamp Assy.	Price
A20T DDUNR4	1.250	12	1.000	1.700	DNMG 432	IDSN 433	PB4-SS	PB4-CA	\$336.00
A24U DDUNR4	1.500	14	1.125	1.965		IDSN 433	PB4-SS	PB4-CA	\$408.00

Also available in: Modular pg: 82 Chatter-Free pg: 104



Hardware
pg: 186



Inserts
pg: 167

Proudly Made in Flushing, MI USA

B

BORING

Steel Boring Bars (Negative)

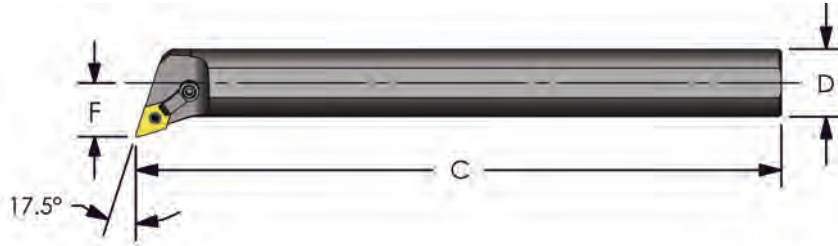

4:1 Ratio

Negative 55° Diamond (-17.5° Lead) Profiling

No Coolant

Designation	D Dia.	C OAL	F	Min Bore	Insert	Shim Seat	Clamp	Clamp Screw	Lock Pin	Price
S20T MDQNR/L4	1.250	12	1.000	1.700	DNMG 432	IDSN-433	CL-22	XNS-48	NL-46	\$260.00
S24U MDQNR/L4	1.500	14	1.125	1.960		IDSN-433	CL-22	XNS-48	NL-46	\$298.00

Negative 55° Diamond (-17.5° Lead) Profiling

Coolant Thru

Designation	D Dia.	C OAL	F	Min Bore	Insert	Shim Seat	Clamp	Clamp Screw	Lock Pin	Price
A20T MDQNR/L4	1.250	12	1.000	1.700	DNMG 432	IDSN-433	CL-22	XNS-48	NL-46	\$290.00
A24U MDQNR/L4	1.500	14	1.125	1.960		IDSN-433	CL-22	XNS-48	NL-46	\$333.00

Also available in: [Modular pg: 80](#)

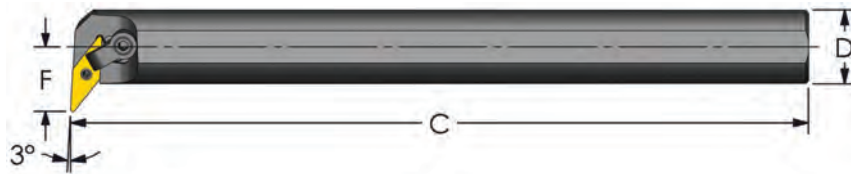

4:1 Ratio

Negative 35° Diamond (-3° Lead) Profiling

No Coolant

Designation	D Dia.	C OAL	F	Min Bore	Insert	Shim Seat	Clamp	Clamp Screw	Lock Pin	Price
S16S MVUNR3	1.000	10	.875	1.435	VNMG 332	IVSN-322	CL-20	XNS-47	NL-34L	\$206.00
S20T MVUNR3	1.250	12	1.000	1.705		IVSN-322	CL-20	XNS-47	NL-34L	\$260.00
S24U MVUNR3	1.500	14	1.120	1.960		IVSN-322	CL-20	XNS-47	NL-34L	\$298.00

Negative 35° Diamond (-3° Lead) Profiling

Coolant Thru

Designation	D Dia.	C OAL	F	Min Bore	Insert	Shim Seat	Clamp	Clamp Screw	Lock Pin	Price
A16S MVUNR3	1.000	10	.875	1.435	VNMG 332	IVSN-322	CL-20	XNS-47	NL-34L	\$187.00
A20T MVUNR3	1.250	12	1.000	1.705		IVSN-322	CL-20	XNS-47	NL-34L	\$264.00
A24U MVUNR3	1.500	14	1.120	1.960		IVSN-322	CL-20	XNS-47	NL-34L	\$304.00

Also available in: [Carbide pg: 62](#) [Modular pg: 81](#) [Chatter-Free pg: 96](#)

B

BORING

Steel Boring Bars

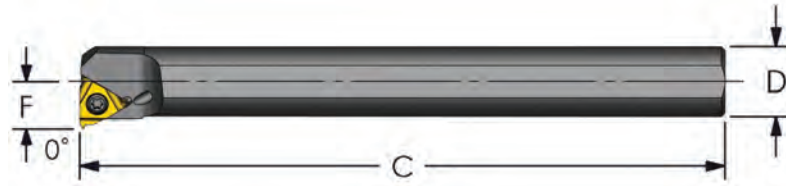

4:1 Ratio

Threading/Grooving Laydown

Coolant Thru

Designation Right Hand	D Dia.	C OAL	F	L	Min Bore	Insert	Insert Screw	Anvil Screw	Anvil	Price
A08M LSER2	.500	6	.308	--	.588	2IR	SR34505	--	--	\$93.00
A10Q LSER2	.625	7	.371	--	.721		SR34505	--	--	\$113.00
A12Q LSER3	.750	7	.510	--	.935	3IR	MTS-35	--	--	\$131.00
A16R LSER3	1.000	8	.650	--	1.210		SA3T	SY3T	Y13	\$180.00

Designation Left Hand	D Dia.	C OAL	F	L	Min Bore	Insert	Insert Screw	Anvil Screw	Anvil	Price
A12Q LSEL3	.750	7	.510	--	.935	3IL	MTS-35	--	--	\$131.00
A16R LSEL3	1.000	8	.650	--	1.210		SA3T	SY3T	YE3	\$180.00

Also available in: Carbide pg: 63 Modular pg: 83 Chatter-Free pg: 89,97,106

B

BORING

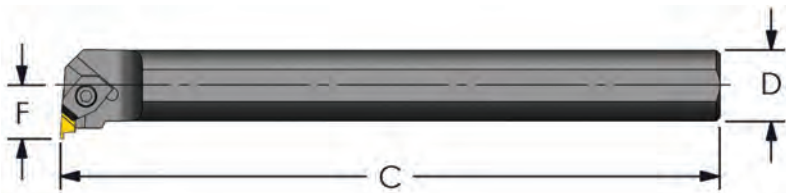

4:1 Ratio

Threading/Grooving Top Notch

No Coolant

Designation Right Hand	D Dia.	C OAL	F	Min Bore	Insert	Clamp	Clamp Screw	Price
S08M NER2	.500	6	.437	.730	NG 2L	CM-147	6-32	\$155.00
S10Q NER2	.625	7	.500	1.000		CM-75	6-32	\$146.00
S12Q NER2	.750	7	.562	1.120		CM-75	6-32	\$149.00
S16R NER3	1.000	8	.688	1.250	NG 3L	CM-73	10-32	\$198.00
Designation Left Hand	D Dia.	C OAL	F	Min Bore	Insert	Clamp	Clamp Screw	Price
S08M NEL2	.500	6	.437	.730	NG 2R	CM-146	6-32	\$155.00
S10Q NEL2	.625	7	.500	1.000		CM-74	6-32	\$146.00
S12Q NEL2	.750	7	.562	1.120		CM-74	6-32	\$149.00
S16R NEL3	1.000	8	.688	1.250	NG 3R	CM-72	10-32	\$198.00

Also available in: Carbide pg: 63 Modular pg: 84 Chatter-Free pg: 98,106



Hardware
pg: 186



Inserts
pg: 167

Proudly Made in Flushing, MI USA

Steel Boring Bars (Kits)

B
BORING

Steel Boring Bar Kits

Coolant Thru



Order No.: PDBK-356

- (1) A06K SCLCR2 (3/8" Bar)
- (1) A08M SCLCR2 (1/2" Bar)
- (1) A10Q SCLCR2 (5/8" Bar)
- (5) CCMT 21.51 ZX3-UD51

\$246.00



Order No.: PDBK-671

- (1) A10Q SCLCR3 (5/8" Bar)
- (1) A12Q SCLCR3 (3/4" Bar)
- (1) A16R SCLCR3 (1" Bar)
- (5) CCMT 32.51 ZX3-UD51

\$322.00

Mini-Steel Boring Bar Kits

No Coolant



Order No.: PDBK-MINI

- (1) S03G SCLDR1.2
- (1) S03.5G SCLDR1.5
- (1) S04G SCLDR1.5
- (1) S05G SCLPR1.8

- (2) CDHB 1.20.60 UD51
- (2) CDGW 1.510 UD51
- (2) CPMT 1.81.20.5 LX6-UD52

**ONLY
\$215.00**

Right Hand Bar	D Dia.	C OAL	F	Min. Bore
S03G SCLDR1.2 *	.187	3.5	.102	.205
S03.5G SCLDR1.5 *	.218	3.5	.125	.245
S04G SCLDR1.5 *	.250	3.5	.172	.312
S05G SCLPR1.8*	.312	3.5	.219	.395

* bars .312 and smaller do not have flats

Steel Boring Bars (Reduced Neck)

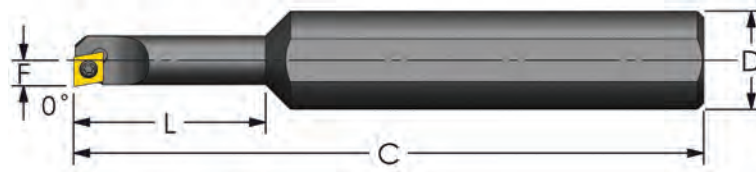

Positive 80° Diamond (0° Lead) Reduced Neck

No Coolant

Designation	D Dia.	C OAL	L Neck Length	F	Min Bore	Insert	Insert Screw	Key	Price
SCFDR2-5	.625	4	.500	.138	.276	CDGW 1.510	MTS-184	T-6	\$91.00
SCFDR2-15	.625	4	1.000	.138	.276		MTS-184	T-6	\$91.00
SCFDR2-25	.625	4	.750	.167	.334		MTS-184	T-6	\$91.00
SCFDR2-35	.625	4	1.250	.167	.334		MTS-184	T-6	\$91.00
SCFDR2-45	.625	4	1.000	.203	.450		MTS-184	T-6	\$91.00
SCFDR2-55	.625	4	1.500	.203	.450		MTS-184	T-6	\$91.00

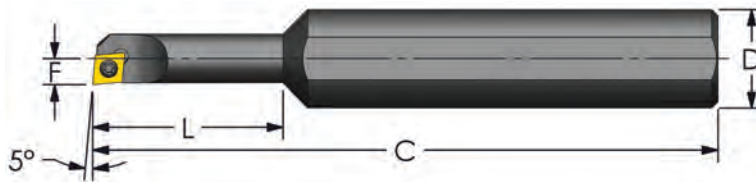

Positive 80° Diamond (-5° Lead) Reduced Neck

No Coolant

Designation	D Dia.	C OAL	L Neck Length	F	Min Bore	Insert	Insert Screw	Key	Price
SCLDR2-5	.625	4	.500	.138	.276	CDGW 1.510	MTS-184	T-6	\$91.00
SCLDR2-15	.625	4	1.000	.138	.276		MTS-184	T-6	\$91.00
SCLDR2-25	.625	4	.750	.167	.334		MTS-184	T-6	\$91.00
SCLDR2-35	.625	4	1.250	.167	.334		MTS-184	T-6	\$91.00
SCLDR2-45	.625	4	1.000	.203	.450		MTS-184	T-6	\$91.00
SCLDR2-55	.625	4	1.500	.203	.450		MTS-184	T-6	\$91.00

B

BORING



Hardware
pg: 186



Inserts
pg: 167

Proudly Made in Flushing, MI USA

Steel Boring Bars (Reduced Neck)

B
BORING

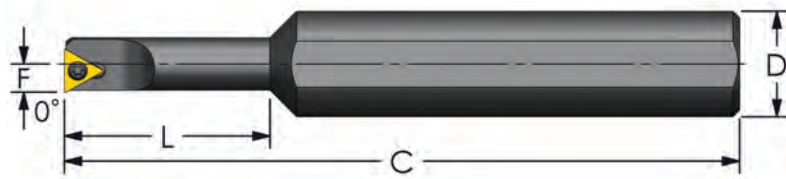

Positive Triangle (0° Lead) Reduced Neck

No Coolant

Designation	D Dia.	C OAL	L Neck Length	F	Min Bore	Insert	Insert Screw	Key	Price
STFCR2-5	.625	4	.500	.138	.276	TCMT 1.21.20.5	MTS-184	T-6	\$91.00
STFCR2-15	.625	4	1.000	.138	.276		MTS-184	T-6	\$91.00
STFCR2-25	.625	4	.750	.167	.334		MTS-184	T-6	\$91.00
STFCR2-35	.625	4	1.250	.167	.334		MTS-184	T-6	\$91.00
STFCR2-45	.625	4	1.000	.203	.450		MTS-184	T-6	\$91.00
STFCR2-55	.625	4	1.500	.203	.450		MTS-184	T-6	\$91.00

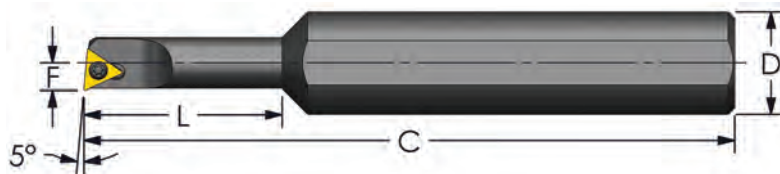

Positive Triangle (-5° Lead) Reduced Neck

No Coolant

Designation	D Dia.	C OAL	L Neck Length	F	Min Bore	Insert	Insert Screw	Key	Price
STLCR2-5	.625	4	.500	.138	.276	TCMT 1.21.20.5	MTS-184	T-6	\$91.00
STLCR2-15	.625	4	1.000	.138	.276		MTS-184	T-6	\$91.00
STLCR2-25	.625	4	.750	.167	.334		MTS-184	T-6	\$91.00
STLCR2-35	.625	4	1.250	.167	.334		MTS-184	T-6	\$91.00
STLCR2-45	.625	4	1.000	.203	.450		MTS-184	T-6	\$91.00
STLCR2-55	.625	4	1.500	.203	.450		MTS-184	T-6	\$91.00

Steel Boring Bars (Reduced Neck)

SERIES "C"

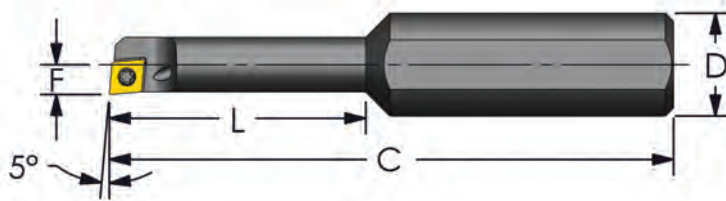

Positive 80° Diamond (-5° Lead) Reduced Neck

Coolant Thru

Designation	D Dia.	Head Dia.	C OAL	L Neck Length	F	Min Bore	Insert	Insert Screw	Key	Price
CSUD-180/375-1/2-5R	.375	.180	2.5	.500	.104	.208	CDHB 1.20.60.5	MTS-183	T-6	\$119.00
CSUD-180/375-1-5R	.375	.180	2.5	1.000	.104	.208		MTS-183	T-6	\$119.00
CSUD-203/375-1/2-5R	.375	.203	2.5	.500	.116	.230		MTS-183	T-6	\$119.00
CSUD-203/375-1-5R	.375	.203	2.5	1.000	.116	.230		MTS-183	T-6	\$119.00
CSUD-250/375-1 1/4-5R	.375	.250	2.5	1.250	.145	.285		MTS-183	T-6	\$116.00
CSUD-180/500-1/2-5R	.500	.180	2.75	.500	.104	.208		MTS-183	T-6	\$124.00
CSUD-180/500-1-5R	.500	.180	2.75	1.000	.104	.208		MTS-183	T-6	\$124.00
CSUD-203/500-1/2-5R	.500	.203	2.75	.500	.116	.230		MTS-183	T-6	\$130.00
CSUD-203/500-1-5R	.500	.203	2.75	1.000	.116	.230		MTS-183	T-6	\$124.00
CSUD-250/500-3/4-5R	.500	.250	2.75	.750	.145	.285		MTS-184	T-6	\$124.00
CSUD-250/500-1 1/4-5R	.500	.250	2.75	1.250	.145	.285		MTS-184	T-6	\$124.00

Also available in: Carbide pg: 64

SERIES "F, Q"

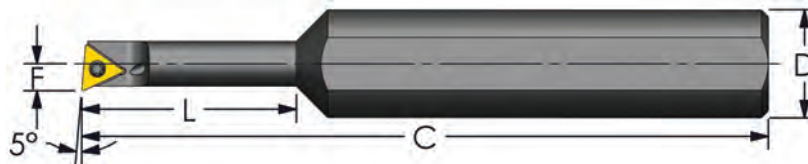

Positive Triangle (-5° Lead) Reduced Neck

Coolant Thru

Designation	D Dia.	Head Dia.	C OAL	L Neck Length	F	Min Bore	Insert	Insert Screw	Key	Price
FSUD-203/500-1/2-5R	.500	.203	3	.500	.126	.275	TDHB 1.280.750.5	MTS-224	T-7	\$114.00
FSUD-203/500-1-5R	.500	.203	3	1.000	.126	.275		MTS-224	T-7	\$123.00
FSUD-250/500-3/4-5R	.500	.259	3	.750	.156	.300		MTS-224	T-7	\$119.00
FSUD-312/500-1-5R	.500	.321	3	1.000	.187	.360		MTS-224	T-7	\$114.00
FSUD-312/500-1 1/2-5R	.500	.321	3	1.500	.187	.360		MTS-224	T-7	\$123.00
FSUD-203/625-1/2-5R	.625	.203	4	.500	.126	.275		MTS-224	T-7	\$131.00
FSUD-250/625-3/4-5R	.625	.259	4	.750	.156	.300		MTS-224	T-7	\$119.00
FSUD-250/625-1 1/4-5R	.625	.259	4	1.250	.156	.300		MTS-224	T-7	\$119.00
FSUD-312/625-1-5R	.625	.321	4	1.000	.187	.360		MTS-224	T-7	\$119.00
QSUD-375/500-1 1/8-5R	.500	.390	3.75	1.125	.221	.438		TPCB 220.5	ETS 4-40	T-10
QSUD-375/500-1 7/8-5R	.500	.390	3.75	1.875	.221	.438	ETS 4-40		T-10	\$114.00
QSUD-375/625-1 1/8-5R	.625	.390	4.25	1.125	.221	.438	ETS 4-40		T-10	\$124.00
QSUD-375/625-1 7/8-5R	.625	.390	4.25	1.875	.221	.438	ETS 4-40		T-10	\$124.00
QSUD-375/750-1 1/2-5R	.750	.390	4	1.500	.221	.438	ETS 4-40		T-10	\$133.00
QSUD-625/750-2 1/2-5R	.750	.635	4.5	2.500	.353	.688	ETS 4-40		T-10	\$146.00

Also available in: Carbide pg: 64



Hardware
pg: 186



Inserts
pg: 167

Proudly Made in Flushing, MI USA

Carbide Boring Bars

CARBIDE BORING BARS

B
BORING

MAXIMUM Rigidity / Efficiency

For use in TOUGHER application

8:1 Ratio

.156" - 1.5" Diameters

MICHIGAN MADE

Other Pages of Interest

Pg 64 **Reduced Neck Bars**

Pg 65 **Solid Small Boring**

Pg 66 **Cut-Off/Extra Flat Service**

Pg 66 **Steel Coolant Adaptor**



Series Style Boring Bars

pgs **51, 52, 58, 64**



Metric Carbide Boring Bars

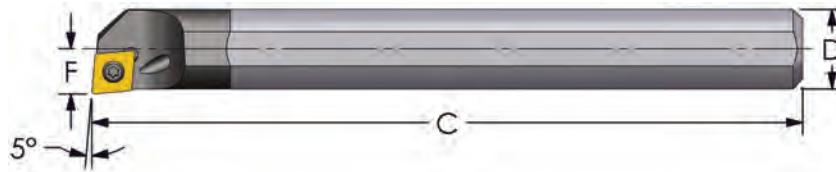

Positive 80° Diamond (-5° Lead)

8:1 Ratio
Coolant Thru

Designation	D Dia. (mm)	C OAL (mm)	F (mm)	Min Bore (mm)	Insert	Insert Screw	Key	Price
M-E06H SCLDR/L04 *	6	100	3.5	7	CDGW 1.510	MTS-184	T-6	\$174.00
M-E08K SCLCR/L06 *	8	125	6	11	CCMT 21.51	MTS-255	T-7	\$183.00
M-E10M SCLCR/L06	10	150	7	13		MTS-255	T-7	\$208.00
M-E12Q SCLCR/L06	12	180	9	16	CCMT 32.51	MTS-255	T-7	\$229.00
M-E16R SCLCR/L09	16	200	11	20		MTS-35	T-15	\$351.00
M-E20S SCLCR/L09	20	250	13	25		MTS-35	T-15	\$487.00
M-E25T SCLCR/L09	25	300	17	32	MTS-35	T-15	\$793.00	

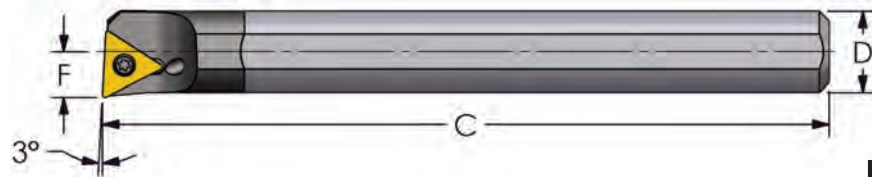

Positive Triangle (-3° Lead)

8:1 Ratio
Coolant Thru

Designation	D Dia. (mm)	C OAL (mm)	F (mm)	Min Bore (mm)	Insert	Insert Screw	Key	Price
M-E06H STUCR/L06 *	6	100	3.5	7	TCMT 1.21.20.5	MTS-184	T-6	\$174.00
M-E08K STUCR/L06 *	8	125	6	11		MTS-184	T-6	\$183.00
M-E10M STUCR/L11	10	150	7	13	TCMT 21.51	MTS-255	T-7	\$208.00
M-E12Q STUCR/L11	12	180	9	16		MTS-255	T-7	\$229.00
M-E16R STUCR/L11	16	200	11	20		MTS-255	T-7	\$351.00
M-E20S STUCR/L16	20	250	13	25	TCMT 32.51	MTS-35	T-15	\$487.00
M-E25T STUCR/L16	25	300	17	32		MTS-35	T-15	\$793.00

*bars 8mm and smaller do not have flats

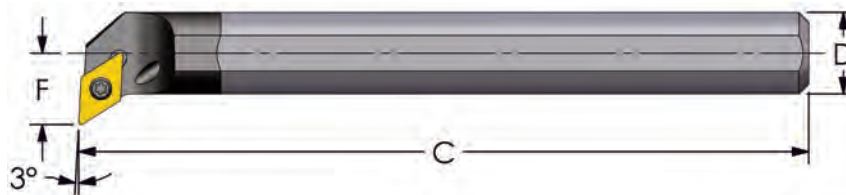

Positive 55° Diamond (-3° Lead) Profiling

8:1 Ratio
Coolant Thru

Designation	D Dia. (mm)	C OAL (mm)	F (mm)	Min Bore (mm)	Insert	Insert Screw	Key	Price
M-E10M SDUCR/L07	10	150	9	15	DCMT 21.51	MTS-255	T-7	\$217.00
M-E12Q SDUCR/L07	12	180	11	18		MTS-255	T-7	\$267.00
M-E16R SDUCR/L07	16	200	13	22		MTS-255	T-7	\$360.00
M-E20S SDUCR/L11	20	250	15	27	DCMT 32.51	MTS-35	T-15	\$497.00
M-E25T SDUCR/L11	25	300	18	33		MTS-35	T-15	\$811.00



Hardware
pg: 186



Inserts
pg: 167

Proudly Made in Flushing, MI USA

B

BORING

Carbide Boring Bars (Positive)

**! USE THE RIGHT SET SCREW
FLAT POINT, NOT CUP POINT !**

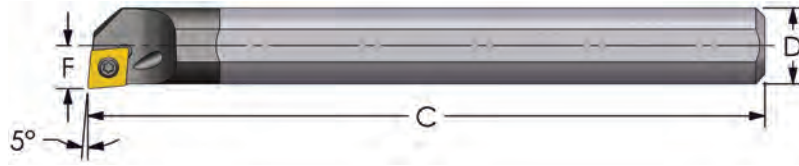

8:1 Ratio

Positive 80° Diamond (-5° Lead)

No Coolant

Designation	D Dia.	C OAL	F	Min Bore	Insert	Insert Screw	Key	Price
C02.5G SCLDR/L1.2 *	.156	3.5	.090	.175	CDHB 1.20.60	MTS-182	T-6	\$156.00
C03H SCLDR/L1.2 *	.187	4	.102	.205		MTS-183	T-6	\$156.00
C03.5H SCLDR/L1.5 *	.218	4	.125	.245	CDGW 1.510	MTS-184	T-6	\$156.00
C04H SCLDR/L1.5 *	.250	4	.172	.312		MTS-184	T-6	\$156.00
C05K SCLPR/L1.8 *	.312	5	.219	.395	CPMT 1.81.20.5	MTS-224	T-7	\$156.00
C06M SCLPR/L2	.375	6	.250	.460	CPMT 21.51	MTS-255	T-7	\$179.00
C08J SCLPR/L2	.500	4.5	.312	.600		MTS-255	T-7	\$202.00
C08R SCLPR/L2	.500	8	.312	.600		MTS-255	T-7	\$232.00
C08J SCLPR/L3	.500	4.5	.344	.625	CPMT 32.51	MTS-35	T-15	\$202.00
C08R SCLPR/L3	.500	8	.344	.625		MTS-35	T-15	\$232.00
C06M SCLCR/L2	.375	6	.250	.460	CCMT 21.51	MTS-255	T-7	\$179.00
C08J SCLCR/L2	.500	4.5	.312	.600		MTS-255	T-7	\$202.00
C08R SCLCR/L2	.500	8	.312	.600		MTS-255	T-7	\$232.00
C08J SCLCR/L3	.500	4.5	.344	.625	CCMT 32.51	MTS-35	T-15	\$202.00
C08R SCLCR/L3	.500	8	.344	.625		MTS-35	T-15	\$232.00

Also available in: [Steel pg: 24](#) [Heavy Metal pg: 68](#)

Minimum Clearance

No Coolant

Designation	D Dia.	C OAL	F	Min Bore	Insert	Insert Screw	Key	Price
C04H SCLDR/L1.5-138 *	.250	4	.138	.275	CDGW 1.510	MTS-184	T-6	\$156.00
C05K SCLPR/L1.8-167 *	.312	5	.167	.340	CPMT 1.81.20.5	MTS-224	T-7	\$156.00
C06M SCLPR/L2-203	.375	6	.203	.410	CPMT 21.51	MTS-255	T-7	\$179.00
C08J SCLPR/L2-281	.500	4.5	.281	.560		MTS-255	T-7	\$202.00
C08R SCLPR/L2-281	.500	8	.281	.560		MTS-255	T-7	\$232.00
C06M SCLCR/L2-203	.375	6	.203	.410	CCMT 21.51	MTS-255	T-7	\$179.00
C08J SCLCR/L2-281	.500	4.5	.281	.560		MTS-255	T-7	\$202.00
C08R SCLCR/L2-281	.500	8	.281	.560		MTS-255	T-7	\$232.00

Minimum Clearance Bars are intended for light machining with minimum bore clearance. Max depth of cut .015" - .020"

* bars .312 and smaller do not have flats

B

BORING

Carbide Boring Bars (Positive)

**! USE THE RIGHT SET SCREW
FLAT POINT, NOT CUP POINT !**

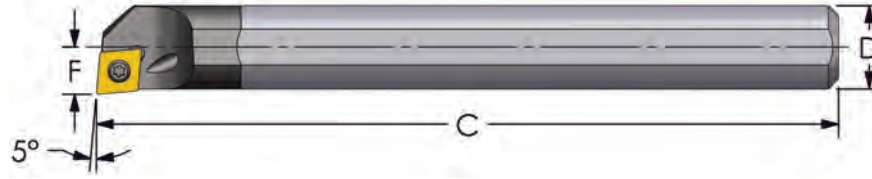

8:1 Ratio

Positive 80° Diamond (-5° Lead)

Coolant Thru

Designation	D Dia.	C OAL	F	Min Bore	Insert	Insert Screw	Key	Price
E02.5G SCLDR/L1.2 *	.156	3.5	.090	.175	CDHB 1.20.60	MTS-183	T-6	\$176.00
E03H SCLDR/L1.2 *	.187	4	.102	.205		MTS-183	T-6	\$176.00
E03.5H SCLDR/L1.5 *	.218	4	.125	.245	CDGW 1.510	MTS-184	T-6	\$176.00
E04H SCLDR/L1.5 *	.250	4	.172	.312		MTS-184	T-6	\$176.00
E05K SCLPR/L1.8 *	.312	5	.219	.395	CPMT 1.81.20.5	MTS 224	T-7	\$176.00
E06M SCLPR/L2	.375	6	.250	.460	CPMT 21.51	MTS-255	T-7	\$197.00
E08J SCLPR/L2	.500	4.5	.312	.600		MTS-255	T-7	\$221.00
E08R SCLPR/L2	.500	8	.312	.600		MTS-255	T-7	\$250.00
E10Q SCLPR/L2	.625	7	.406	.770		MTS-255	T-7	\$311.00
E10S SCLPR/L2	.625	10	.406	.770		MTS-255	T-7	\$379.00
E08J SCLPR/L3	.500	4.5	.344	.625	CPMT 32.51	MTS-35	T-15	\$221.00
E08R SCLPR/L3	.500	8	.344	.625		MTS-35	T-15	\$250.00
E10Q SCLPR/L3	.625	7	.406	.760		MTS-35	T-15	\$311.00
E10S SCLPR/L3	.625	10	.406	.760		MTS-35	T-15	\$379.00
E12Q SCLPR/L3	.750	7	.500	.920		MTS-35	T-15	\$391.00
E12S SCLPR/L3	.750	10	.500	.920		MTS-35	T-15	\$452.00
E16R SCLPR/L3	1.000	8	.625	1.185		MTS-35	T-15	\$578.00
E16T SCLPR/L3	1.000	12	.625	1.185	MTS-35	T-15	\$736.00	

Also available in: [Steel pg: 25](#) [Heavy Metal pg: 68](#) [Modular pg: 74](#) [Chatter-Free pg: 89,92,102](#)

Minimum Clearance

Coolant Thru

Designation	D Dia.	C OAL	F	Min Bore	Insert	Insert Screw	Key	Price
E04H SCLDR/L1.5-138 *	.250	4	.138	.270	CDGW 1.510	MTS-184	T-6	\$176.00
E05K SCLPR/L1.8-167 *	.312	5	.167	.340	CPMT 1.81.20.5	MTS 224	T-7	\$176.00
E06M SCLPR/L2-203	.375	6	.203	.410	CPMT 21.51	MTS-255	T-7	\$197.00
E08J SCLPR/L2-281	.500	4.5	.281	.560		MTS-255	T-7	\$221.00
E08R SCLPR/L2-281	.500	8	.281	.560		MTS-255	T-7	\$250.00

Minimum Clearance Bars are intended for light machining with minimum bore clearance. Max depth of cut .015" - .020"
* bars .312 and smaller do not have flats

B
BORING



Hardware
pg: 186



Inserts
pg: 167

continued on next page...

Proudly Made in Flushing, MI USA

Carbide Boring Bars (Positive)

**! USE THE RIGHT SET SCREW
FLAT POINT, NOT CUP POINT !**

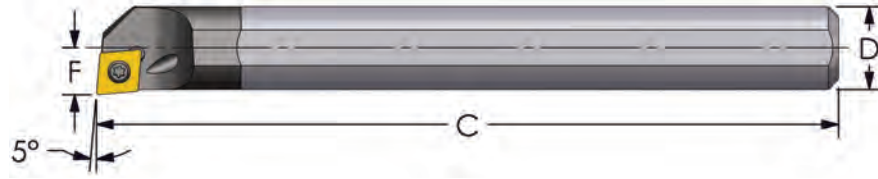

B

BORING

Positive 80° Diamond (-5° Lead)

Coolant Thru

Designation	D Dia.	C OAL	F	Min Bore	Insert	Insert Screw	Key	Price
E06M SCLCR/L2	.375	6	.250	.460	CCMT 21.51	MTS-255	T-7	\$197.00
E08J SCLCR/L2	.500	4.5	.312	.600		MTS-255	T-7	\$221.00
E08R SCLCR/L2	.500	8	.312	.600		MTS-255	T-7	\$250.00
E10Q SCLCR/L2	.625	7	.406	.760		MTS-255	T-7	\$311.00
E10S SCLCR/L2	.625	10	.406	.760		MTS-255	T-7	\$379.00
E08J SCLCR/L3	.500	4.5	.344	.625	CCMT 32.51	MTS-35	T-15	\$221.00
E08R SCLCR/L3	.500	8	.344	.625		MTS-35	T-15	\$250.00
E10Q SCLCR/L3	.625	7	.406	.760		MTS-35	T-15	\$311.00
E10S SCLCR/L3	.625	10	.406	.760		MTS-35	T-15	\$379.00
E12Q SCLCR/L3	.750	7	.500	.920		MTS-35	T-15	\$391.00
E12S SCLCR/L3	.750	10	.500	.920	MTS-35	T-15	\$452.00	
E16R SCLCR/L3	1.000	8	.625	1.185	MTS-35	T-15	\$578.00	
E16T SCLCR/L3	1.000	12	.625	1.185	MTS-35	T-15	\$736.00	
E20U SCLCR/L3	1.250	14	.765	1.465	MTS-35	T-15	\$1,375.00	
E20U SCLCR/L4	1.250	14	.765	1.465	CCMT 432	MTS-4	T-20	\$1,375.00
E24U SCLCR/L4	1.500	14	.890	1.730		MTS-4	T-20	\$1,660.00

Also available in: Steel pg: 25 Heavy Metal pg: 68 Modular pg: 74 Chatter-Free pg: 89,92,102

Minimum Clearance

Coolant Thru

Designation	D Dia.	C OAL	F	Min Bore	Insert	Insert Screw	Key	Price
E06M SCLCR/L2-203	.375	6	.203	.410	CCMT 21.51	MTS-255	T-7	\$197.00
E08J SCLCR/L2-281	.500	4.5	.281	.560		MTS-255	T-7	\$221.00
E08R SCLCR/L2-281	.500	8	.281	.560		MTS-255	T-7	\$250.00

Minimum Clearance Bars are intended for light machining with minimum bore clearance. Max depth of cut .015" - .020"

Carbide Boring Bars (Positive)

**! USE THE RIGHT SET SCREW
FLAT POINT, NOT CUP POINT !**



Positive 80° Diamond (-7° Lead)

8:1 Ratio

Coolant Thru

Designation	D Dia.	C OAL	F	Min Bore	Insert	Insert Screw	Key	Price
CCUD-165/156-6-7R *	.156	6	.095	.180	CDHB 1.20.60.5	MTS-183	T-6	\$212.00

Also available in: [Steel pg: 26](#)

* bars .312 and smaller do not have flats



Positive 80° Diamond (-5° Lead)

8:1 Ratio

Coolant Thru

Designation	D Dia.	C OAL	F	Min Bore	Insert	Insert Screw	Key	Price
CCUD-180/187-4-5R *	.187	4	.104	.208	CDHB 1.20.60.5	MTS-183	T-6	\$200.00
CCUD-180/187-6-5R *	.187	6	.104	.208		MTS-183	T-6	\$212.00
CCUD-187-4-5R *	.187	4	.111	.222		MTS-183	T-6	\$200.00
CCUD-187-6-5R *	.187	6	.111	.222		MTS-183	T-6	\$212.00
CCUD-250-4-5R *	.250	4	.145	.285		MTS-184	T-6	\$200.00
CCUD-250-6-5R *	.250	6	.145	.285		MTS-184	T-6	\$212.00
CCUD-312-5-5R *	.312	5	.185	.360	CDGW 1.510	MTS-184	T-6	\$212.00
CCUD-250-4-5R-1.5 *	.250	4	.145	.285		MTS-184	T-6	\$200.00

Also available in: [Steel pg: 26](#)

* bars .312 and smaller do not have flats

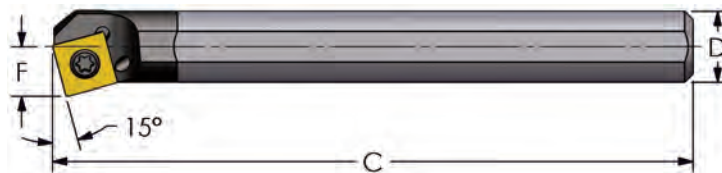

Positive Square (15° Lead)

8:1 Ratio

Coolant Thru

Designation	D Dia.	C OAL	F	Min Bore	Insert	Insert Screw	Key	Price
E08R SSKCR3	.500	8	.344	.625	SCMT 32.51	MTS-35	T-15	\$250.00
E10S SSKCR3	.625	10	.406	.760		MTS-35	T-15	\$379.00

Also available in: [Steel pg: 26](#)

[Modular pg: 75](#)



Hardware
pg: 186



Inserts
pg: 167

Proudly Made in Flushing, MI USA

B

BORING

Carbide Boring Bars (Positive)

**! USE THE RIGHT SET SCREW
FLAT POINT, NOT CUP POINT !**

SERIES "G, Q, S"

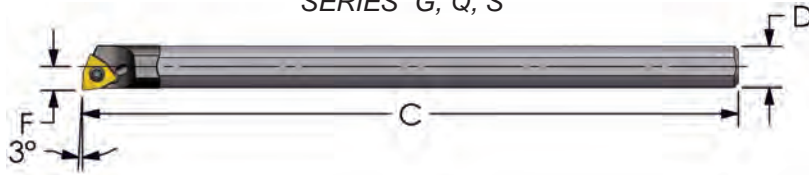

Positive Trigon (-3° Lead)

8:1 Ratio
Coolant Thru

Designation	D Dia.	C OAL	F	Min Bore	Insert	Insert Screw	Key	Price
GCUDW-187-6-3R/L	.187	6	.126	.260	WPGT 1.511	MTS-184	T-6	\$200.00
GCUDW-250-6-3R/L	.250	6	.143	.285		MTS-184	T-6	\$200.00
GCUDW-312-6-3R/L	.312	6	.174	.374		MTS-184	T-6	\$200.00
QCUDW-375-6-3R/L	.375	6	.211	.415	WPGT 21.50	MTS-255	T-7	\$226.00
QCUDW-500-8-3R/L	.500	8	.273	.540		MTS-255	T-7	\$292.00
SCUDW-625-10-3R	.625	10	.345	.675	WPMT 32.51	MTS-35	T-15	\$506.00
SCUDW-750-10-3R	.750	10	.407	.800		MTS-35	T-15	\$551.00

Also available in: [Steel pg: 28](#)

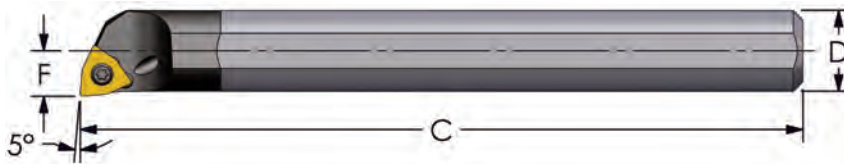

Positive Trigon (-5° Lead)

8:1 Ratio
No Coolant

Designation	D Dia.	C OAL	F	Min Bore	Insert	Insert Screw	Key	Price
C03H SWLCR1.2 *	.187	4	.102	.205	WCMT 1.210.5	MTS-183	T-6	\$171.00
C04H SWLCR1.2 *	.250	4	.172	.312		MTS-184	T-6	\$171.00
C05K SWLCR1.5 *	.312	5	.219	.395	WCMT 1.51.50.5	MTS-2	T-6	\$171.00
C06M SWLCR/L2	.375	6	.250	.460	WCMT 21.51	MTS-255	T-7	\$179.00
C08J SWLCR/L2	.500	4.5	.312	.600		MTS-255	T-7	\$202.00
C08R SWLCR/L2	.500	8	.312	.600		MTS-255	T-7	\$232.00

Also available in: [Steel pg: 27](#) [Heavy Metal pg: 69](#)

Minimum Clearance

No Coolant

Designation	D Dia.	C OAL	F	Min Bore	Insert	Insert Screw	Key	Price
C04H SWLCR1.2-138 *	.250	4	.138	.275	WCMT 1.210.5	MTS-184	T-6	\$171.00
C05K SWLCR1.5-167 *	.312	5	.167	.345	WCMT 1.51.50.5	MTS-2	T-6	\$171.00
C06M SWLCR/L2-203	.375	6	.203	.400	WCMT 21.51	MTS-255	T-7	\$179.00
C08J SWLCR/L2-281	.500	4.5	.281	.560		MTS-255	T-7	\$202.00
C08R SWLCR/L2-281	.500	8	.281	.560		MTS-255	T-7	\$232.00

Minimum Clearance Bars are intended for light machining with minimum bore clearance Max depth of cut .015" - .020"
* bars .312 and smaller do not have flats

B

BORING

Carbide Boring Bars (Positive)

**! USE THE RIGHT SET SCREW
FLAT POINT, NOT CUP POINT !**

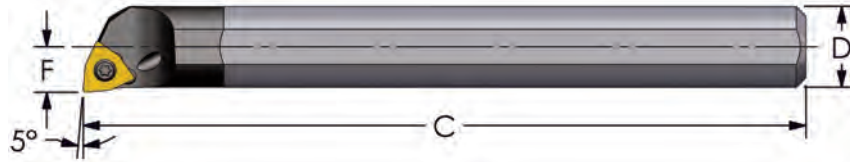

8:1 Ratio

Positive Trigon (-5° Lead)

Coolant Thru

Designation	D Dia.	C OAL	F	Min Bore	Insert	Insert Screw	Key	Price
E03H SWLCR1.2 *	.187	4	.102	.205	WCMT 1.210.5	MTS-183	T-6	\$188.00
E04H SWLCR1.2 *	.250	4	.172	.395		MTS-184	T-6	\$188.00
E05K SWLCR1.5 *	.312	5	.219	.410	WCMT 1.51.50.5	MTS-2	T-6	\$188.00
E06M SWLCR/L2	.375	6	.250	.460	WCMT 21.51	MTS-255	T-7	\$197.00
E08J SWLCR/L2	.500	4.5	.312	.600		MTS-255	T-7	\$221.00
E08R SWLCR/L2	.500	8	.312	.600		MTS-255	T-7	\$250.00
E10Q SWLCR/L2	.625	7	.406	.760		MTS-255	T-7	\$311.00
E10S SWLCR/L2	.625	10	.406	.760		MTS-255	T-7	\$379.00
E10Q SWLCR/L3	.625	7	.406	.760	WCMT 32.51	MTS-35	T-15	\$311.00
E10S SWLCR/L3	.625	10	.406	.760		MTS-35	T-15	\$379.00
E12Q SWLCR/L3	.750	7	.500	.920		MTS-35	T-15	\$391.00
E12S SWLCR/L3	.750	10	.500	.920		MTS-35	T-15	\$452.00
E16R SWLCR/L3	1.000	8	.625	1.185		MTS-35	T-15	\$578.00
E16T SWLCR/L3	1.000	12	.625	1.185		MTS-35	T-15	\$736.00

Also available in: [Steel pg: 27](#) [Heavy Metal pg: 69](#) [Modular pg: 75](#)

Minimum Clearance

Coolant Thru

Designation	D Dia.	C OAL	F	Min Bore	Insert	Insert Screw	Key	Price
E04H SWLCR1.2-138 *	.250	4	.138	.275	WCMT 1.210.5	MTS-184	T-6	\$188.00
E05K SWLCR1.5-167 *	.312	5	.167	.345	WCMT 1.51.50.5	MTS-2	T-6	\$188.00
E06M SWLCR/L2-203	.375	6	.203	.410	WCMT 21.51	MTS-255	T-7	\$197.00
E08J SWLCR/L2-281	.500	4.5	.281	.560		MTS-255	T-7	\$221.00
E08R SWLCR/L2-281	.500	8	.281	.560		MTS-255	T-7	\$250.00

Minimum Clearance Bars are intended for light machining with minimum bore clearance. Max depth of cut .015" - .020"
*bars .312 and smaller do not have flats

B

BORING



Hardware
pg: 186



Inserts
pg: 167

Proudly Made in Flushing, MI USA

Carbide Boring Bars (Positive)

**! USE THE RIGHT SET SCREW
FLAT POINT, NOT CUP POINT !**

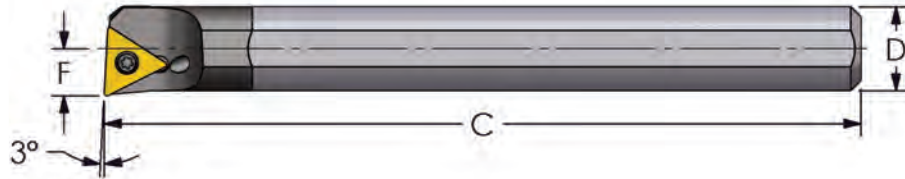

8:1 Ratio

Positive Triangle (-3° Lead)

No Coolant

Designation	D Dia.	C OAL	F	Min Bore	Insert	Insert Screw	Key	Price
C04H STUCR/L1.2 *	.250	4	.172	.312	TCMT 1.21.20.5	MTS-184	T-6	\$156.00
C05K STUCR/L1.2 *	.312	5	.219	.395		MTS-184	T-6	\$156.00
C06M STUCR/L2	.375	6	.250	.460	TCMT 21.51	MTS-255	T-7	\$186.00
C08J STUCR/L2	.500	4.5	.312	.600		MTS-255	T-7	\$202.00
C08R STUCR/L2	.500	8	.312	.600		MTS-255	T-7	\$232.00
C06M STUPR/L2	.375	6	.250	.460	TPMT 21.51	MTS-255	T-7	\$186.00
C08J STUPR/L2	.500	4.5	.312	.600		MTS-255	T-7	\$202.00
C08R STUPR/L2	.500	8	.312	.600		MTS-255	T-7	\$232.00

Also available in: [Steel pg: 29](#) [Heavy Metal pg: 70](#)

Minimum Clearance

No Coolant

Designation	D Dia.	C OAL	F	Min Bore	Insert	Insert Screw	Key	Price
C04H STUCR/L1.2-138 *	.250	4	.138	.275	TCMT 1.21.20.5	MTS-184	T-6	\$156.00
C05K STUCR/L1.2-167 *	.312	5	.167	.340		MTS-184	T-6	\$156.00
C06M STUCR/L2-203	.375	6	.203	.410	TCMT 21.51	MTS-255	T-7	\$186.00
C08J STUCR/L2-281	.500	4.5	.281	.560		MTS-255	T-7	\$202.00
C08R STUCR/L2-281	.500	8	.281	.570		MTS-255	T-7	\$232.00
C06M STUPR/L2-203	.375	6	.203	.410	TPMT 21.51	MTS-255	T-7	\$186.00
C08J STUPR/L2-281	.500	4.5	.281	.560		MTS-255	T-7	\$202.00
C08R STUPR/L2-281	.500	8	.281	.560		MTS-255	T-7	\$232.00

Minimum Clearance Bars are intended for light machining with minimum bore clearance. Max depth of cut .015" - .020"
* bars .312 and smaller do not have flats



**MICHIGAN
MANUFACTURED**

Carbide Boring Bars (Positive)

**! USE THE RIGHT SET SCREW
FLAT POINT, NOT CUP POINT !**

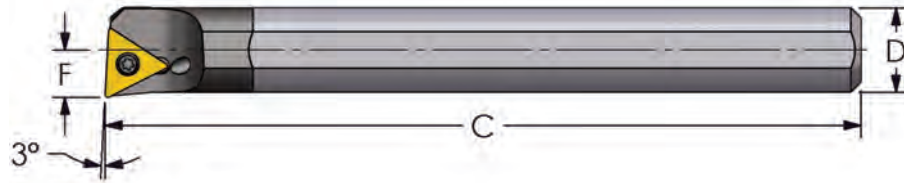

8:1 Ratio

Positive Triangle (-3° Lead)

Coolant Thru

Designation	D Dia.	C OAL	F	Min Bore	Insert	Insert Screw	Key	Price
E04H STUCR/L1.2 *	.250	4	.172	.312	TCMT 1.21.20.5	MTS-184	T-6	\$176.00
E05K STUCR/L1.2 *	.312	5	.219	.395		MTS-184	T-6	\$176.00
E06M STUCR/L2	.375	6	.250	.460	TCMT 21.51	MTS-255	T-7	\$197.00
E08J STUCR/L2	.500	4.5	.312	.600		MTS-255	T-7	\$221.00
E08R STUCR/L2	.500	8	.312	.600		MTS-255	T-7	\$250.00
E10Q STUCR/L2	.625	7	.406	.760		MTS-255	T-7	\$311.00
E10S STUCR/L2	.625	10	.406	.760		MTS-255	T-7	\$379.00
E12Q STUCR/L3	.750	7	.500	.920	TCMT 32.51	MTS-35	T-15	\$391.00
E12S STUCR/L3	.750	10	.500	.920		MTS-35	T-15	\$452.00
E16R STUCR/L3	1.000	8	.625	1.185		MTS-35	T-15	\$578.00
E16T STUCR/L3	1.000	12	.625	1.185		MTS-35	T-15	\$736.00
E06M STUPR/L2	.375	6	.250	.460	TPMT 21.51	MTS-255	T-7	\$197.00
E08J STUPR/L2	.500	4.5	.312	.600		MTS-255	T-7	\$221.00
E08R STUPR/L2	.500	8	.312	.600		MTS-255	T-7	\$250.00
E10Q STUPR/L2	.625	7	.406	.760		MTS-255	T-7	\$311.00
E10S STUPR/L2	.625	10	.406	.760		MTS-255	T-7	\$379.00
E12Q STUPR/L3	.750	7	.500	.920	TPMT 32.51	MTS-35	T-15	\$391.00
E12S STUPR/L3	.750	10	.500	.920		MTS-35	T-15	\$452.00
E16R STUPR/L3	1.000	8	.625	1.185		MTS-35	T-15	\$578.00
E16T STUPR/L3	1.000	12	.625	1.185		MTS-35	T-15	\$736.00

Also available in: Steel pg: 30 Heavy Metal pg: 70 Modular pg: 75 Chatter-Free pg: 92,102

Minimum Clearance

Coolant Thru

Designation	D Dia.	C OAL	F	Min Bore	Insert	Insert Screw	Key	Price
E04H STUCR/L1.2-138 *	.250	4	.138	.275	TCMT 1.21.20.5	MTS-184	T-6	\$176.00
E05K STUCR/L1.2-167 *	.312	5	.167	.340		MTS-184	T-6	\$176.00
E06M STUCR/L2-203	.375	6	.203	.410	TCMT 21.51	MTS-255	T-7	\$197.00
E08J STUCR/L2-281	.500	4.5	.281	.560		MTS-255	T-7	\$221.00
E08R STUCR/L2-281	.500	8	.281	.560		MTS-255	T-7	\$250.00
E06M STUPR/L2-203	.375	6	.203	.410	TPMT 21.51	MTS-255	T-7	\$197.00
E08J STUPR/L2-281	.500	4.5	.281	.560		MTS-255	T-7	\$221.00
E08R STUPR/L2-281	.500	8	.281	.560		MTS-255	T-7	\$250.00

Minimum Clearance Bars are intended for light machining with minimum bore clearance. Max depth of cut .015" - .020"
* bars .312 and smaller do not have flats



Hardware
pg: 186



Inserts
pg: 167

Proudly Made in Flushing, MI USA

B

BORING

Carbide Boring Bars (Positive)

**! USE THE RIGHT SET SCREW
FLAT POINT, NOT CUP POINT !**

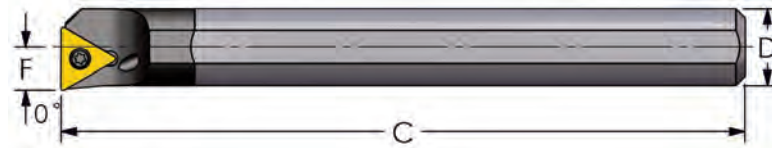

8:1 Ratio

No Coolant

Positive Triangle (0° Lead)

Designation	D Dia.	C OAL	F	Min Bore	Insert	Insert Screw	Key	Price
C06M STFPR2	.375	6	.250	.460	TPMT 21.51	MTS-255	T-7	\$179.00
C08J STFPR2	.500	4.5	.312	.600		MTS-255	T-7	\$202.00
C08R STFPR2	.500	8	.312	.600		MTS-255	T-7	\$232.00
C06M STFCR2	.375	6	.250	.460	TCMT 21.51	MTS-255	T-7	\$179.00
C08J STFCR2	.500	4.5	.312	.600		MTS-255	T-7	\$202.00
C08R STFCR2	.500	8	.312	.600		MTS-255	T-7	\$232.00

Also available in: Steel pg: 31

Minimum Clearance

No Coolant

Designation	D Dia.	C OAL	F	Min Bore	Insert	Insert Screw	Key	Price
C06M STFPR2-203	.375	6	.203	.410	TPMT 21.51	MTS-255	T-7	\$179.00
C08J STFPR2-281	.500	4.5	.281	.560		MTS-255	T-7	\$202.00
C08R STFPR2-281	.500	8	.281	.560		MTS-255	T-7	\$232.00
C06M STFCR2-203	.375	6	.203	.410	TCMT 21.51	MTS-255	T-7	\$179.00
C08J STFCR2-281	.500	4.5	.281	.560		MTS-255	T-7	\$202.00
C08R STFCR2-281	.500	8	.281	.560		MTS-255	T-7	\$232.00

Minimum Clearance Bars are intended for light machining with minimum bore clearance. Max depth of cut .015" - .020"



B

BORING

**! USE THE RIGHT SET SCREW
FLAT POINT, NOT CUP POINT !**

Carbide Boring Bars (Positive)

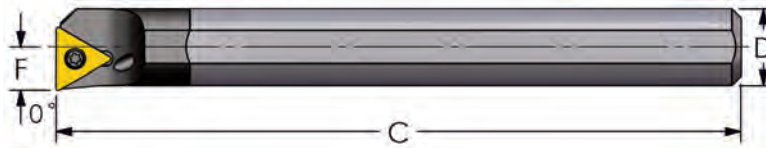

8:1 Ratio

Positive Triangle (0° Lead)

Coolant Thru

Designation	D Dia.	C OAL	F	Min Bore	Insert	Insert Screw	Key	Price
E06M STFPR2	.375	6	.250	.460	TPMT 21.51	MTS-255	T-7	\$197.00
E08J STFPR2	.500	4.5	.312	.600		MTS-255	T-7	\$221.00
E08R STFPR2	.500	8	.312	.600		MTS-255	T-7	\$250.00
E10Q STFPR2	.625	7	.406	.760		MTS-255	T-7	\$311.00
E10S STFPR2	.625	10	.406	.760		MTS-255	T-7	\$379.00
E12Q STFPR3	.750	7	.500	.920	TPMT 32.51	MTS-35	T-15	\$391.00
E12S STFPR3	.750	10	.500	.920		MTS-35	T-15	\$452.00
E16R STFPR3	1.000	8	.625	1.185		MTS-35	T-15	\$578.00
E16T STFPR3	1.000	12	.625	1.185		MTS-35	T-15	\$736.00
E06M STFCR2	.375	6	.250	.460	TCMT 21.51	MTS-255	T-7	\$197.00
E08J STFCR2	.500	4.5	.312	.600		MTS-255	T-7	\$221.00
E08R STFCR2	.500	8	.312	.600		MTS-255	T-7	\$250.00
E10Q STFCR2	.625	7	.406	.760		MTS-255	T-7	\$311.00
E10S STFCR2	.625	10	.406	.760		MTS-255	T-7	\$379.00
E12Q STFCR3	.750	7	.500	.920	TCMT 32.51	MTS-35	T-15	\$391.00
E12S STFCR3	.750	10	.500	.920		MTS-35	T-15	\$452.00
E16R STFCR3	1.000	8	.625	1.185		MTS-35	T-15	\$578.00
E16T STFCR3	1.000	12	.625	1.185		MTS-35	T-15	\$736.00

Also available in: Modular pg: 75 Steel pg: 32 Chatter-Free pg: 93,102

Minimum Clearance

Coolant Thru

Designation	D Dia.	C OAL	F	Min Bore	Insert	Insert Screw	Key	Price
E06M STFPR2-203	.375	6	.203	.410	TPMT 21.51	MTS-255	T-7	\$197.00
E08J STFPR2-281	.500	4.5	.281	.560		MTS-255	T-7	\$221.00
E08R STFPR2-281	.500	8	.281	.560		MTS-255	T-7	\$250.00
E06M STFCR2-203	.375	6	.203	.410	TCMT 21.51	MTS-255	T-7	\$197.00
E08J STFCR2-281	.500	4.5	.281	.560		MTS-255	T-7	\$221.00
E08R STFCR2-281	.500	8	.281	.560		MTS-255	T-7	\$250.00

Minimum Clearance Bars are intended for light machining with minimum bore clearance. Max depth of cut .015" - .020"



Hardware
pg: 186



Inserts
pg: 167

Proudly Made in Flushing, MI USA

B
BORING

Carbide Boring Bars (Positive)

**! USE THE RIGHT SET SCREW
FLAT POINT, NOT CUP POINT !**

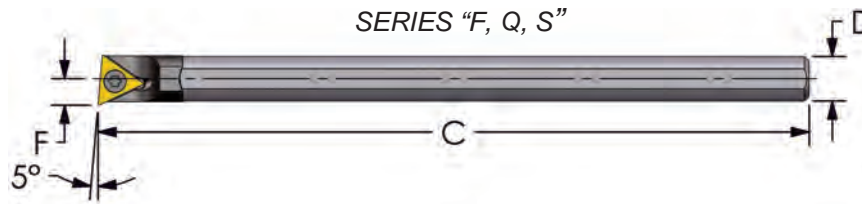

8:1 Ratio

Positive Triangle (-5° Lead)

Coolant Thru

Designation	D Dia.	C OAL	F	Min Bore	Insert	Insert Screw	Key	Price
FCUD-187-4-5R *	.187	4	.126	.275	TDHB 1.280.750.5	MTS-224	T-7	\$186.00
FCUD-187-6-5R *	.187	6	.126	.275		MTS-224	T-7	\$217.00
FCUD-250-4-5R *	.250	4	.156	.300		MTS-224	T-7	\$186.00
FCUD-250-6-5R *	.250	6	.156	.300		MTS-224	T-7	\$200.00
FCUD-312-4-5R *	.312	4	.187	.360		MTS-224	T-7	\$186.00
FCUD-312-6-5R *	.312	6	.187	.360		MTS-224	T-7	\$200.00
QCUD-375-6-5R	.375	6	.228	.438	TPCB 220.5	ETS 4-40	T-10	\$226.00
QCUD-375-10-5R	.375	10	.228	.438		ETS 4-40	T-10	\$248.00
QCUD-500-8-5R	.500	8	.296	.563		ETS 4-40	T-10	\$292.00
SCUD-625-6-5R	.625	6	.393	.731	TD 320.5	ETS 4-40	T-10	\$292.00
SCUD-625-10-5R	.625	10	.393	.731		ETS 4-40	T-10	\$440.00
SCUD-750-10-5R	.750	10	.460	.855		ETS 4-40	T-10	\$506.00
SCUD-1000-12-5R	1.000	12	.585	1.105		ETS 4-40	T-10	\$620.00

Also available in: **Steel pg: 28**

*bars .312 and smaller do not have flats

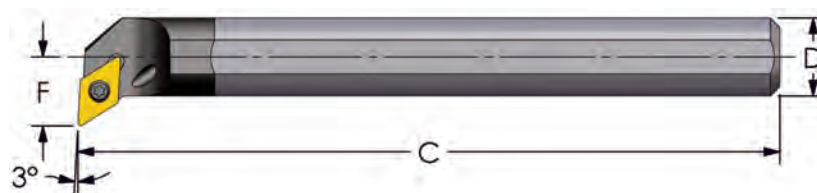

8:1 Ratio

Positive 55° Diamond (-3° Lead) Profiling

No Coolant

Designation	D Dia.	C OAL	F	Min Bore	Insert	Insert Screw	Key	Price
C06M SDUCR/L2	.375	6	.375	.585	DCMT 21.51	MTS-255	T-7	\$188.00
C08J SDUCR/L2	.500	4.5	.437	.720		MTS-255	T-7	\$219.00
C08R SDUCR/L2	.500	8	.437	.720		MTS-255	T-7	\$249.00

Also available in: **Steel pg: 33**

B

BORING

Carbide Boring Bars (Positive)

**! USE THE RIGHT SET SCREW
FLAT POINT, NOT CUP POINT !**

Positive 55° Diamond (-3° Lead) Profiling

Coolant Thru

Designation	D Dia.	C OAL	F	Min Bore	Insert	Insert Screw	Key	Price
E06M SDUCR/L2	.375	6	.375	.585	DCMT 21.51	MTS-255	T-7	\$207.00
E08J SDUCR/L2	.500	4.5	.437	.720		MTS-255	T-7	\$228.00
E08R SDUCR/L2	.500	8	.437	.720		MTS-255	T-7	\$261.00
E10Q SDUCR/L2	.625	7	.500	.850		MTS-255	T-7	\$321.00
E10S SDUCR/L2	.625	10	.500	.850		MTS-255	T-7	\$390.00
E12Q SDUCR/L3	.750	7	.625	1.050	DCMT 32.51	MTS-35	T-15	\$400.00
E12S SDUCR/L3	.750	10	.625	1.050		MTS-35	T-15	\$463.00
E16R SDUCR/L3	1.000	8	.750	1.310		MTS-35	T-15	\$594.00
E16T SDUCR/L3	1.000	12	.750	1.310		MTS-35	T-15	\$755.00
E12Q SDUPR/L3	.750	7	.625	1.050	DPMT 32.51	MTS-35	T-15	\$400.00
E12S SDUPR/L3	.750	10	.625	1.050		MTS-35	T-15	\$463.00
E16R SDUPR/L3	1.000	8	.750	1.310		MTS-35	T-15	\$594.00
E16T SDUPR/L3	1.000	12	.750	1.310		MTS-35	T-15	\$755.00

Also available in: Steel pg: 33 Modular pg: 76 CFT pg: 89,93,103

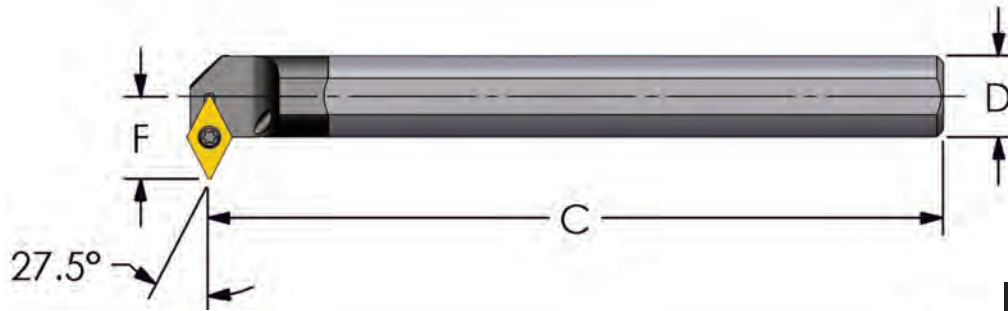

8:1 Ratio

Positive 55° Diamond (27.5° Lead) Profiling

Coolant Thru

Designation	D Dia.	C OAL	F	Min Bore	Insert	Insert Screw	Key	Price
E10Q SDNCR2	.625	6.86	.562	.920	DCMT 21.51	MTS-255	T-7	\$321.00
E12S SDNCR3	.750	9.80	.765	1.190	DCMT 32.51	MTS-35	T-15	\$463.00

Also available in: Modular pg: 76 Chatter-Free pg: 103

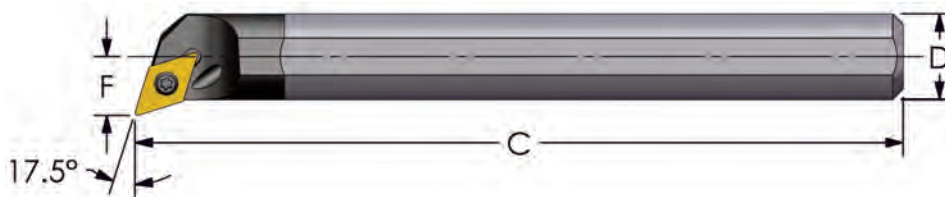

8:1 Ratio

Positive 55° Diamond (-17.5° Lead) Profiling

Coolant Thru

Designation	D Dia.	C OAL	F	Min Bore	Insert	Insert Screw	Key	Price
E06M SDQCR2	.375	6	.281	.490	DCMT 21.51	MTS-255	T-7	\$207.00
E08R SDQCR2	.500	8	.341	.620		MTS-255	T-7	\$261.00
E10S SDQCR2	.625	10	.406	.760		MTS-255	T-7	\$390.00

Also available in: Modular pg: 76

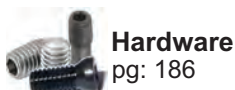

Hardware
pg: 186



Inserts
pg: 167

Proudly Made in Flushing, MI USA

B

BORING

Carbide Boring Bars (Positive)

**! USE THE RIGHT SET SCREW
FLAT POINT, NOT CUP POINT !**

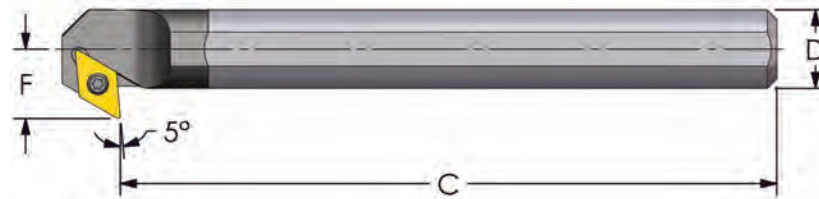

8:1 Ratio

Positive 55° Diamond (5° Lead) Back Facing

No Coolant

Designation	D Dia.	C OAL	F	Min Bore	Insert	Insert Screw	Key	Price
C06M SDXCR/L2	.375	6	.375	.585	DCMT 21.51	MTS-255	T-7	\$188.00
C08J SDXCR/L2	.500	4.5	.437	.720		MTS-255	T-7	\$199.70
C08R SDXCR/L2	.500	8	.437	.720		MTS-255	T-7	\$227.14

Also available in: [Steel pg: 35](#)

Positive 55° Diamond (5° Lead) Back Facing

Coolant Thru

Designation	D Dia.	C OAL	F	Min Bore	Insert	Insert Screw	Key	Price
E06M SDXCR/L2	.375	6	.375	.585	DCMT 21.51	MTS-255	T-7	\$207.00
E08J SDXCR/L2	.500	4.5	.437	.720		MTS-255	T-7	\$228.00
E08R SDXCR/L2	.500	8	.437	.720		MTS-255	T-7	\$261.00
E10Q SDXCR/L2	.625	7	.500	.850		MTS-255	T-7	\$321.00
E10S SDXCR/L2	.625	10	.500	.850		MTS-255	T-7	\$390.00
E12Q SDXCR/L3	.750	7	.625	1.050	DCMT 32.51	MTS-35	T-15	\$400.00
E12S SDXCR/L3	.750	10	.625	1.050		MTS-35	T-15	\$463.00
E16R SDXCR/L3	1.000	8	.750	1.310		MTS-35	T-15	\$594.00
E16T SDXCR/L3	1.000	12	.750	1.310		MTS-35	T-15	\$755.00

Also available in: [Steel pg: 35](#) [Modular pg: 77](#) [Chatter-Free pg: 103](#)

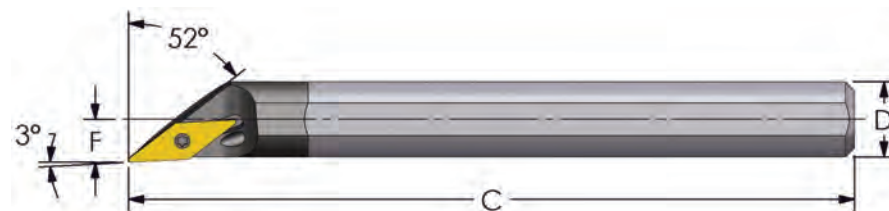

8:1 Ratio

Positive 35° Diamond (-52° Lead) Profiling

Coolant Thru

Designation	D Dia.	C OAL	F	Min Bore	Insert	Insert Screw	Key	Price
E06M SVJBR2	.375	6	.223	.445	VBMT 21.51	MTS-2.5L	T-7	\$207.00
E08R SVJBR2	.500	8	.285	.570		MTS-2.5L	T-7	\$261.00
E10S SVJBR2	.625	10	.348	.700		MTS-2.5L	T-7	\$390.00
E12S SVJBR3	.750	10	.421	.840	VBMT 331	MTS-3.5L	T-15	\$463.00

Also available in: [Steel pg: 32](#) [Modular pg: 77](#)

B

BORING



**! USE THE RIGHT SET SCREW
FLAT POINT, NOT CUP POINT !**

Carbide Boring Bars

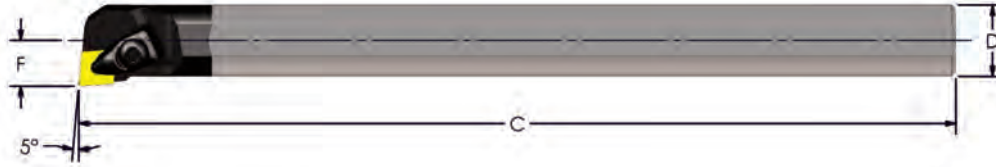

Negative 80° Diamond (-5° Lead) Shank

Coolant Thru 8:1 Ratio

Designation	D Dia.	C OAL	F	Min Bore	Insert	Shim	Shim Screw	Clamp Assy.	Price
E16T DCLNR4	1.000	12	.640	1.200	CNMG 432	--	--	PB4-CA	\$794.00
E20U DCLNR4	1.250	14	.765	1.470		ICSN 433	PB4-SS	PB4-CA	\$1,452.00

Also available in: Modular pg: 82 Chatter-Free pg: 104

B

BORING

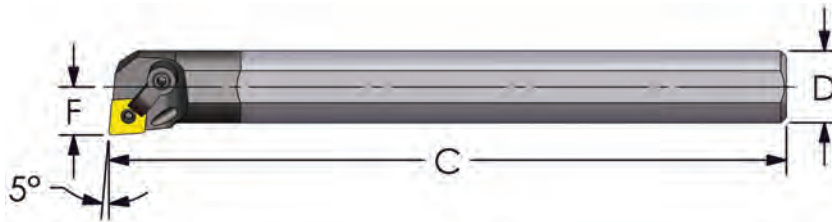

Negative 80° Diamond (-5° Lead)

8:1 Ratio

Coolant Thru

Designation	D Dia.	C OAL	F	Min Bore	Insert	Shim Seat	Clamp	Clamp Screw	Lock Pin	Price
E12Q MCLNR/L3	.750	7	.500	.920	CNMG 322	--	CL-7	XNS-36	NL-33	\$425.00
E12S MCLNR/L3	.750	10	.500	.920		--	CL-7	XNS-36	NL-33	\$489.00
E16R MCLNR/L3	1.000	8	.640	1.200		--	CL-7	XNS-36	NL-33	\$613.00
E16T MCLNR/L3	1.000	12	.640	1.200		--	CL-7	XNS-36	NL-33	\$770.00
E16R MCLNR/L4	1.000	8	.640	1.200	CNMG 432	--	CL-20	XNS-47	NL-44	\$613.00
E16T MCLNR/L4	1.000	12	.640	1.200		--	CL-20	XNS-47	NL-44	\$770.00
E20U MCLNR/L4	1.250	14	.765	1.470		ICSN-433	CL-20	XNS-47	NL-46	\$1,425.00
E24U MCLNR/L4	1.500	14	.890	1.730		ICSN-433	CL-20	XNS-47	NL-46	\$1,698.00

Also available in: Steel pg: 36 Modular pg: 78 Chatter-Free pg: 94



Hardware
pg: 186



Inserts
pg: 167

Proudly Made in Flushing, MI USA



Carbide Boring Bars (Negative)

**! USE THE RIGHT SET SCREW
FLAT POINT, NOT CUP POINT !**

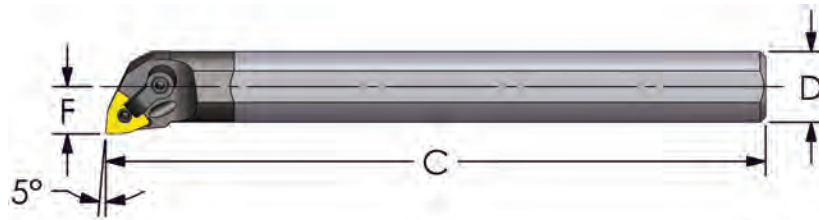

8:1 Ratio

Negative Trigon (-5° Lead)

Coolant Thru

Designation	D Dia.	C OAL	F	Min Bore	Insert	Shim Seat	Clamp	Clamp Screw	Lock Pin	Price
E12Q MWLNR/L3	.750	7	.500	.920	WNMG 332	--	CL-7	XNS-36	NL-33L	\$425.00
E12S MWLNR/L3	.750	10	.500	.920		--	CL-7	XNS-36	NL-33L	\$489.00
E16R MWLNR/L3	1.000	8	.640	1.200		--	CL-7	XNS-36	NL-33L	\$613.00
E16T MWLNR/L3	1.000	12	.640	1.200		--	CL-7	XNS-36	NL-33L	\$770.00
E16R MWLNR/L4	1.000	8	.640	1.200	WNMG 432	--	CL-20	XNS-47	NL-44	\$613.00
E16T MWLNR/L4	1.000	12	.640	1.200		--	CL-20	XNS-47	NL-44	\$770.00
E20U MWLNR/L4	1.250	14	.765	1.470		IWSN-433	CL-20	XNS-47	NL-46	\$1,425.00
E24U MWLNR/L4	1.500	14	.890	1.730		IWSN-433	CL-20	XNS-47	NL-46	\$1,698.00

Also available in: [Steel pg: 37](#) [Modular pg: 79](#) [Chatter-Free pg: 95](#)



Negative 55° Diamond (-3° Lead) Shank

Coolant Thru 8:1 Ratio

Designation	D Dia.	C OAL	F	Min Bore	Insert	Shim	Shim Screw	Clamp Assy.	Price
E20U DDUNR4	1.250	14	1.000	1.700	DNMG 432	IDSN 433	PB4-SS	PB4-CA	\$1,452.00

Also available in: [Steel pg: 39](#) [Modular pg: 82](#) [Chatter-Free pg: 104](#)

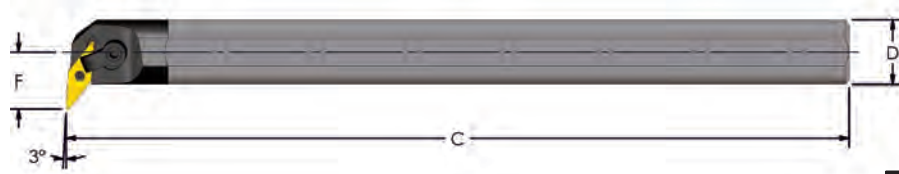

8:1 Ratio

Negative 35° Diamond (-3° Lead) Profiling

No Coolant

Designation	D Dia.	C OAL	F	Min Bore	Insert	Shim Seat	Clamp	Clamp Screw	Lock Pin	Price
E16T MVUNR3	1.000	12	.875	1.435	VNMG 332	IVSN-322	CL-20	XNS-47	NL-34L	\$712.00
E20U MVUNR3	1.250	14	1.000	1.705		IVSN-322	CL-20	XNS-47	NL-34L	\$1310.00
E24U MVUNR3	1.500	14	1.120	1.960		IVSN-322	CL-20	XNS-47	NL-34L	\$1559.00

Also available in: [Steel pg: 40](#) [Modular pg: 81](#) [Chatter-Free pg: 96](#)

B

BORING

Carbide Boring Bars (Laydown/Top Notch)

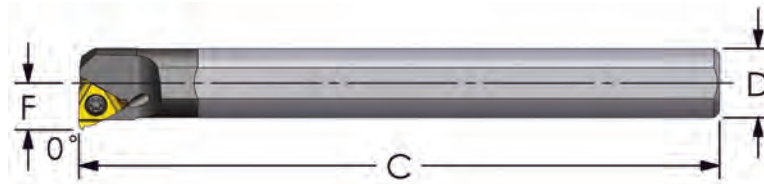

8:1 Ratio

Threading/Grooving Laydown

Coolant Thru

Designation Right Hand	D Dia.	C OAL	F	Min Bore	Insert	Insert Screw	Anvil Screw	Anvil	Price
E08R LSER2	.500	8	.308	.588	2IR	SR34505L	--	--	\$261.00
E10Q LSER2	.625	7	.371	.721		SR34505L	--	--	\$322.00
E12Q LSER3	.750	7	.510	.935	3IR	MTS-35	--	--	\$425.00
E12S LSER3	.750	10	.510	.935		MTS-35	--	--	\$489.00
E16R LSER3	1.000	8	.650	1.210		SA3T	SY3T	YI3	\$613.00
E16T LSER3	1.000	12	.650	1.210		SA3T	SY3T	YI3	\$770.00

Designation Left Hand	D Dia.	C OAL	F	Min Bore	Insert	Insert Screw	Anvil Screw	Anvil	Price
E08R LSEL2	.500	8	.308	.588	2IL	SR34505L	--	--	\$261.00
E10Q LSEL2	.625	7	.371	.721		SR34505L	--	--	\$322.00
E12Q LSEL3	.750	7	.510	.935	3IL	MTS-35	--	--	\$425.00
E12S LSEL3	.750	10	.510	.935		MTS-35	--	--	\$489.00
E16R LSEL3	1.000	8	.650	1.210		SA3T	SY3T	YE3	\$613.00
E16T LSEL3	1.000	12	.650	1.210		SA3T	SY3T	YE3	\$770.00

Also available in: [Steel pg: 40](#) [Modular pg: 83](#) [Chatter-Free pg: 89,97,106](#)

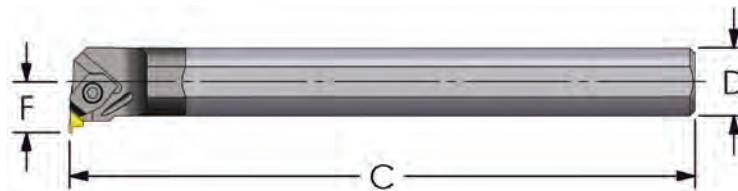

8:1 Ratio

Threading/Grooving Top Notch

Coolant Thru

Designation Right Hand	D Dia.	C OAL	F	Min Bore	Insert	Clamp	Clamp Screw	Price
E08R NER2	.500	8	.437	.730	NG 2L	CM-147	6-32	\$356.00
E10S NER2	.625	10	.500	1.000		CM-75	6-32	\$488.00
E12S NER2	.750	10	.562	1.120		CM-75	6-32	\$569.00

Designation Left Hand	D Dia.	C OAL	F	Min Bore	Insert	Clamp	Clamp Screw	Price
E08R NEL2	.500	8	.437	.730	NG 2R	CM-146	6-32	\$356.00
E10S NEL2	.625	10	.500	1.000		CM-74	6-32	\$488.00
E12S NEL2	.750	10	.562	1.120		CM-74	6-32	\$569.00

Also available in: [Steel pg: 41](#) [Modular pg: 84](#) [Chatter-Free pg: 98,106](#)

B
BORING



Hardware
pg: 186



Inserts
pg: 167

Proudly Made in Flushing, MI USA

Carbide Boring Bars (Reduced Neck)

**! USE THE RIGHT SET SCREW
FLAT POINT, NOT CUP POINT !**

B

BORING

SERIES "C"

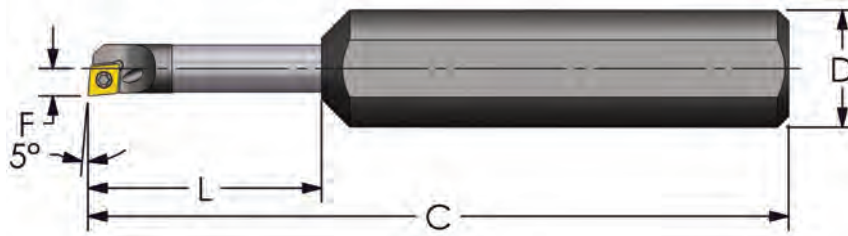

Positive 80° Diamond (-5° Lead) Reduced Neck

Coolant Thru

Designation	D Dia.	Head Dia.	C OAL	L Neck Length	F	Min Bore	Insert	Insert Screw	Key	Price
CCUD-180/500-7/8-5R	.500	.189	2.38	.875	.104	.208	CDHB 1.20.60.5	MTS-183	T-6	\$267.00
CCUD-203/500-1-5R	.500	.210	2.5	1.000	.119	.230		MTS-183	T-6	\$267.00
CCUD-180/625-7/8-5R	.625	.189	3	.875	.104	.208		MTS-183	T-6	\$296.00
CCUD-203/625-1-5R	.625	.210	3.5	1.000	.119	.230		MTS-183	T-6	\$267.00
CCUD-250/625-1 1/4-5R	.625	.260	3	1.250	.145	.285		MTS-184	T-6	\$286.00

Also available in: **Steel pg: 45**

SERIES "F"

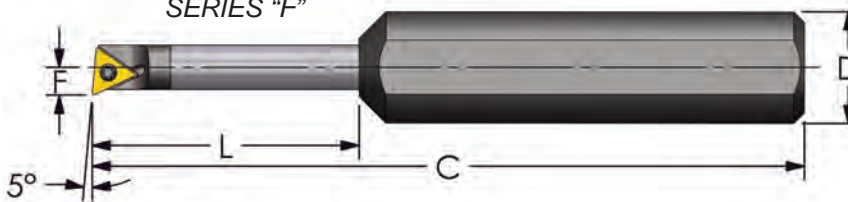

Positive Triangle (-5° Lead) Reduced Neck

Coolant Thru

Designation	D Dia.	Head Dia.	C OAL	L Neck Length	F	Min Bore	Insert	Insert Screw	Key	Price
FCUD-250/500-1 1/4-5R	.500	.260	2.75	1.250	.156	.300	TDHB 1.280.750.5	MTS-224	T-7	\$254.00
FCUD-312/500-3 1/8-5R	.500	.322	4.63	3.125	.187	.360		MTS-224	T-7	\$259.00
FCUD-250/625-1 1/4-5R	.625	.260	4	1.250	.156	.300		MTS-224	T-7	\$267.00
FCUD-312/625-1 1/2-5R	.625	.322	4	1.500	.187	.360		MTS-224	T-7	\$267.00

Also available in: **Steel pg: 45**



**! USE THE RIGHT SET SCREW
FLAT POINT, NOT CUP POINT !**

SOLID Carbide Boring Bars

SOLID CARBIDE SMALL BORING BARS

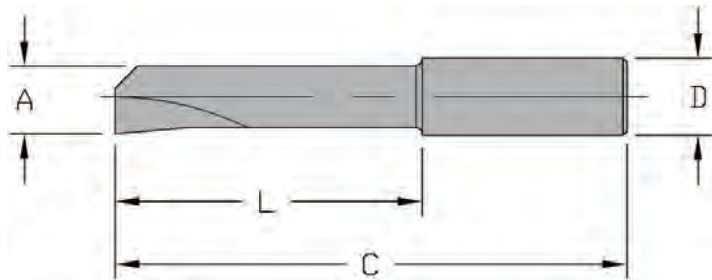

Coated & Uncoated

B

BORING

New sizes available!

8:1 Ratio

Positive 80° Diamond

No Coolant

New sizes

Designation	A Min Hole Dia.	L Max Depth	D Shank Dia.	C OAL	Price by Grade		
					UD5	UD51	UD52
UD125-060-75R	.020	.075	.125	1.500	\$36.00	\$43.00	\$45.00
UD125-060-100R	.030	.100	.125		\$33.00	\$36.00	\$43.00
UD125-060-150R	.040	.150	.125		\$33.00	\$36.00	\$43.00
UD125-060-150R	.050	.150	.125		\$26.00	\$27.00	\$28.00
UD125-060-188R	.060	.188	.125		\$23.00	\$26.00	\$27.00
UD125-080-375R	.080	.375	.125		\$23.00	\$26.00	\$27.00
UD125-090-500R	.090	.500	.125		\$23.00	\$26.00	\$27.00
UD125-120-625R	.120	.625	.125		\$23.00	\$26.00	\$27.00
UD188-150-750R	.150	.750	.188	2.000	\$28.00	\$32.00	\$32.00
UD188-180-1.00R	.180	1.000	.188		\$28.00	\$32.00	\$32.00
UD250-210-1.25R	.210	1.250	.250	2.500	\$36.00	\$44.00	\$46.00
UD250-240-1.25R	.240	1.250	.250		\$37.00	\$45.00	\$47.00
UD312-270-1.25R	.270	1.250	.312		\$46.00	\$53.00	\$55.00
UD312-300-1.25R	.300	1.250	.312		\$46.00	\$53.00	\$55.00
UD375-330-1.50R	.330	1.500	.375		\$63.00	\$71.00	\$73.00
UD375-360-1.50R	.360	1.500	.375		\$63.00	\$71.00	\$73.00

UD5 Uncoated – Used for machining carbon alloy steels, this grade of insert provides excellent toughness and wear resistance.

UD51 General purpose Tin (CVD) coated steel grade - used for roughing and semi-finishing of carbon alloy and stainless steel.

UD52 Tough general purpose steel grade with multi-layer titanium aluminum nitride coating for alloy steel, aluminum alloys, austenitic stainless and carbon steels, copper alloys and exotic alloys.



Hardware
pg: 186



Inserts
pg: 167

Proudly Made in Flushing, MI USA

Carbide Boring Bar Services

**! USE THE RIGHT SET SCREW
FLAT POINT, NOT CUP POINT !**

The following services are for **Carbide** bars only:

Cut-Off Service	Extra-Flat Service
up to 3/8" diameter: \$15	up to 5/16" diameter: \$19
1/2" diameter: \$20	3/8" - 1/2" diameter: \$24
5/8" diameter: \$25	5/8" - 3/4" diameter: \$29
3/4" diameter: \$30	1" - 2" diameter: \$51
1" diameter: \$45	
1 1/4" diameter: \$55	
1 1/2" diameter: \$80	
1 3/4" diameter: \$90	
2" diameter: \$105	

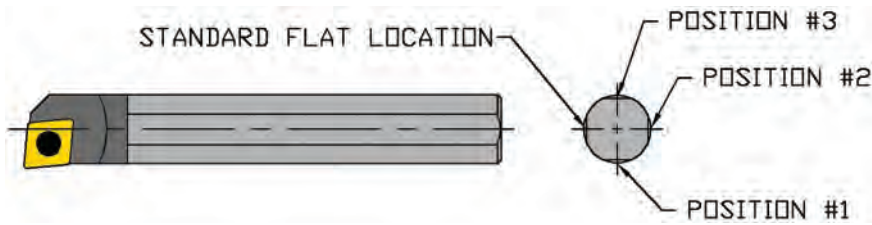

Ordering is easy, Use part # "Cut-Off" and specify the length in the item description
Use part # "Extra-Flat" and specify the location in the item description

Have us braze on a steel coolant adapter to any Carbide Boring Bar 1/2" or larger!



Comes with 1/16-27 NPT (or) 1/8-27 NPT
Plastic loc-line NOT included

Item Designations:
Coolant Adapter - 1/16
Coolant Adapter - 1/8

**ONLY
\$41.00**

Designation Depends on the Diameter of the Bar:
Coolant Adapter-1/16 for 1/2" Diameter Bars
Coolant Adapter-1/8 for 5/8" Diameter Bars and Larger

B

BORING

HEAVY METAL BORING BARS

Vibration DAMPENING

Help Reduce Chatter in your Application

- Machine Deeper Bores
- Achieve Better Precision and Finish

6:1 Ratio

.187" - .750" Diameters

**MADE IN
MICHIGAN**



B

BORING



Hardware
pg: 186



Inserts
pg: 167

Heavy Metal Boring Bars (Positive)

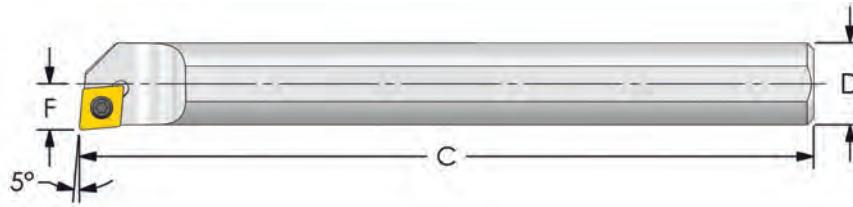

6:1 Ratio

No Coolant

Positive 80° Diamond (-5° Lead)

Designation	D Dia.	C OAL	F	Min Bore	Insert	Insert Screw	Key	Price
J03F SCLDR/L1.2 *	.187	3	.102	.205	CDHB 1.20.60	MTS-183	T-6	\$109.00
J04F SCLDR/L1.5-138 * ■	.250	3	.138	.275	CDGW 1.510	MTS-184	T-6	\$120.00
J05H SCLPR/L1.8-167 * ■	.312	4	.167	.340	CPMT 1.81.20.5	MTS-224	T-7	\$146.00

Also available in: Steel pg: 23 Carbide pg: 48

Positive 80° Diamond (-5° Lead)

Coolant Thru

Designation	D Dia.	C OAL	F	Min Bore	Insert	Insert Screw	Key	Price
HM06J SCLPR/L2-203 ■	.375	4.5	.203	.410	CPMT 21.51	MTS-255	T-7	\$144.00
HM06Q SCLPR/L2-203 ■	.375	7	.203	.410		MTS-255	T-7	\$189.00
HM08J SCLPR/L2-281 ■	.500	4.5	.281	.560		MTS-255	T-7	\$185.00
HM08Q SCLPR/L2-281 ■	.500	7	.281	.560		MTS-255	T-7	\$257.00
HM10J SCLPR/L2	.625	4.5	.406	.760		MTS-255	T-7	\$240.00
HM10Q SCLPR/L2	.625	7	.406	.760		MTS-255	T-7	\$320.00
HM10J SCLPR/L3	.625	4.5	.406	.760	CPMT 32.51	MTS-35	T-15	\$240.00
HM10Q SCLPR/L3	.625	7	.406	.760		MTS-35	T-15	\$320.00
HM12J SCLPR/L3	.750	4.5	.500	.920		MTS-35	T-15	\$342.00
HM12Q SCLPR/L3	.750	7	.500	.920		MTS-35	T-15	\$475.00

HM06J SCLCR/L2-203 ■	.375	4.5	.203	.410	CCMT 21.51	MTS-255	T-7	\$144.00
HM06Q SCLCR/L2-203 ■	.375	7	.203	.410		MTS-255	T-7	\$189.00
HM08J SCLCR/L2-281 ■	.500	4.5	.281	.560		MTS-255	T-7	\$185.00
HM08Q SCLCR/L2-281 ■	.500	7	.281	.560		MTS-255	T-7	\$257.00
HM10J SCLCR/L2	.625	4.5	.406	.760		MTS-255	T-7	\$240.00
HM10Q SCLCR/L2	.625	7	.406	.760		MTS-255	T-7	\$320.00
HM10J SCLCR/L3	.625	4.5	.406	.760	CCMT 32.51	MTS-35	T-15	\$240.00
HM10Q SCLCR/L3	.625	7	.406	.760		MTS-35	T-15	\$320.00
HM12J SCLCR/L3	.750	4.5	.500	.920		MTS-35	T-15	\$342.00
HM12Q SCLCR/L3	.750	7	.500	.920		MTS-35	T-15	\$475.00

Also available in: Steel pg: 25 Carbide pg: 49,50 Modular pg: 79 Chatter-Free pg: 89,92,102

■ Minimum Clearance Bars are intended for light machining with minimum bore clearance. Max depth of cut .015" - .020"
 * bars .312 and smaller do not have flats



BORING

Heavy Metal Boring Bars (Positive)

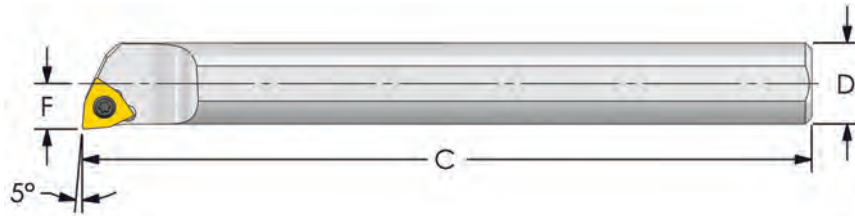

6:1 Ratio

Positive Trigon (-5° Lead)

No Coolant

Designation	D Dia.	C OAL	F	Min Bore	Insert	Insert Screw	Key	Price
J03F SWLCR1.2 *	.187	3	.102	.205	WCMT 1.210.5	MTS-183	T-6	\$109.00
J04F SWLCR1.2-138 * ■	.250	3	.138	.275		MTS-184	T-6	\$120.00
J05H SWLCR1.5-167 * ■	.312	4	.167	.342	WCMT 1.51.50.5	MTS-2	T-6	\$146.00

Also available in: [Steel pg: 27](#) [Carbide pg: 52](#)

B

BORING

Positive Trigon (-5° Lead)

Coolant Thru

Designation	D Dia.	C OAL	F	Min Bore	Insert	Insert Screw	Key	Price
HM06J SWLCR/L2-203 ■	.375	4.5	.203	.410	WCMT 21.51	MTS-255	T-7	\$144.00
HM06Q SWLCR/L2-203 ■	.375	7	.203	.410		MTS-255	T-7	\$189.00
HM08J SWLCR/L2-281 ■	.500	4.5	.281	.560		MTS-255	T-7	\$185.00
HM08Q SWLCR/L2-281 ■	.500	7	.281	.560		MTS-255	T-7	\$257.00
HM10J SWLCR/L2	.625	4.5	.406	.760		MTS-255	T-7	\$240.00
HM10Q SWLCR/L2	.625	7	.406	.760		MTS-255	T-7	\$320.00
HM10J SWLCR/L3	.625	4.5	.406	.760	WCMT 32.51	MTS-35	T-15	\$240.00
HM10Q SWLCR/L3	.625	7	.406	.760		MTS-35	T-15	\$320.00
HM12J SWLCR/L3	.750	4.5	.500	.920		MTS-35	T-15	\$342.00
HM12Q SWLCR/L3	.750	7	.500	.920		MTS-35	T-15	\$475.00

Also available in: [Steel pg: 27](#) [Carbide pg: 53](#) [Modular pg: 75](#)

■ Minimum Clearance Bars are intended for light machining with minimum bore clearance. Max depth of cut .015" - .020"
 * bars .312 and smaller do not have flats



Hardware
pg: 186



Inserts
pg: 167

Proudly Made in Flushing, MI USA

Heavy Metal Boring Bars (Positive)

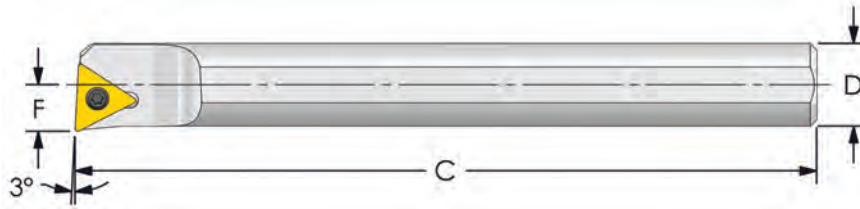

6:1 Ratio

Positive Triangle (-3° Lead)

No Coolant

Designation	D Dia.	C OAL	F	Min Bore	Insert	Insert Screw	Key	Price
J04F STUCR/L1.2-138 * ■	.250	3	.138	.275	TCMT 1.21.20.5	MTS-184	T-6	\$120.00
J05H STUCR/L1.2-167 * ■	.312	4	.167	.340		MTS-184	T-6	\$146.00

Also available in: Steel pg: 29 Carbide pg: 54

Positive Triangle (-3° Lead)

Coolant Thru

Designation	D Dia.	C OAL	F	Min Bore	Insert	Insert Screw	Key	Price	
HM06J STUCR/L1.2-203 ■	.375	4.5	.203	.410	TCMT 1.21.20.5	MTS-184	T-6	\$144.00	
HM06Q STUCR/L1.2-203 ■	.375	7	.203	.410		MTS-184	T-6	\$189.00	
HM06J STUPR/L2-203 ■	.375	4.5	.203	.410	TPMT 21.51	MTS-255	T-7	\$144.00	
HM06Q STUPR/L2-203 ■	.375	7	.203	.410		MTS-255	T-7	\$189.00	
HM08J STUPR/L2-281 ■	.500	4.5	.281	.560		MTS-255	T-7	\$185.00	
HM08Q STUPR/L2-281 ■	.500	7	.281	.560		MTS-255	T-7	\$257.00	
HM10J STUPR/L2	.625	4.5	.406	.760		MTS-255	T-7	\$240.00	
HM10Q STUPR/L2	.625	7	.406	.760		MTS-255	T-7	\$320.00	
HM12J STUPR/L3	.750	4.5	.500	.920		TPMT 32.51	MTS-35	T-15	\$342.00
HM12Q STUPR/L3	.750	7	.500	.920			MTS-35	T-15	\$475.00
HM06J STUCR/L2-203 ■	.375	4.5	.203	.410	TCMT 21.51	MTS-255	T-7	\$144.00	
HM06Q STUCR/L2-203 ■	.375	7	.203	.410		MTS-255	T-7	\$189.00	
HM08J STUCR/L2-281 ■	.500	4.5	.281	.560		MTS-255	T-7	\$185.00	
HM08Q STUCR/L2-281 ■	.500	7	.281	.560		MTS-255	T-7	\$257.00	
HM10J STUCR/L2	.625	4.5	.406	.760		MTS-255	T-7	\$240.00	
HM10Q STUCR/L2	.625	7	.406	.760		MTS-255	T-7	\$320.00	
HM12J STUCR/L3	.750	4.5	.500	.920	TCMT 32.51	MTS-35	T-15	\$342.00	
HM12Q STUCR/L3	.750	7	.500	.920		MTS-35	T-15	\$475.00	

Also available in: Steel pg: 30 Carbide pg: 55 Modular pg: 75 Chatter-Free pg: 92,102

■ Minimum Clearance Bars are intended for light machining with minimum bore clearance. Max depth of cut .015" - .020"
 * bars .312 and smaller do not have flats

B

BORING



MODULAR BORING BARS

Endless Possibilities...

...and the convenience of ONE Bar with 28 different insert style configurations

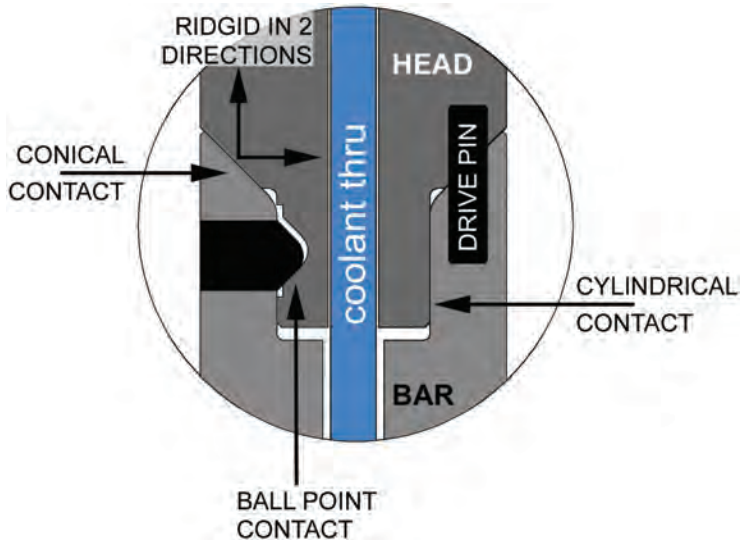

This rigid, high-precision Modular Boring Bar connection is designed with great accuracy to provide a secure union between the bar and the head. The system has internal coolant supply in all components as well.



Modular Boring Bars



4:1 Ratio

Steel Shank

Coolant Thru

Designation	D Dia.	C OAL	Min Bore	Set Screw	Price
MBS 1295	.750	9.5	.930	MH12S	\$136.00
MBS 1612	1.000	11.5	1.200	MH16S	\$159.00
MBS 2014	1.250	14	1.500	MH20S	\$206.00
MBS 2414	1.500	14	1.710	MH24S	\$229.00
MBS 2816	1.750	16	2.010	MH28S	\$273.00
MBS 3210	2.000	10	2.400	MH32S	\$240.00
MBS 3220	2.000	20	2.400	MH32S	\$360.00
MBS 4012*	2.500	12	2.930	MH32S	\$410.00
MBS 4024*	2.500	24	2.930	MH32S	\$624.00
MBS 4828*	3.000	28	3.460	MH32S	\$766.00

* 2.5" and 3" bars take 2" heads

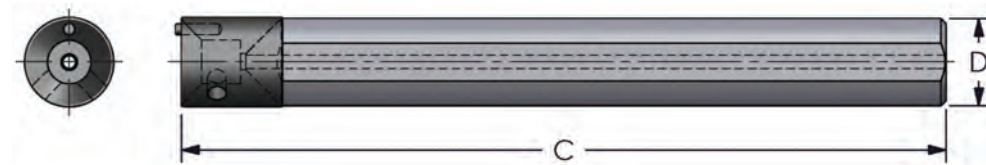

8:1 Ratio

Carbide Shank

Coolant Thru

Designation	D Dia.	C OAL	Min Bore	Set Screw	Price
MB 1295	.750	9.5	.920	MH12S	\$465.00
MB 1220M	20mm	241mm	.930	MH12S	\$540.00
MB 1612	1.000	11.5	1.185	MH16S	\$699.00
MB 2014	1.250	14	1.465	MH20S	\$1,355.00
MB 2414	1.500	14	1.730	MH24S	\$1,593.00
MB 2816	1.750	16	2.010	MH28S	\$2,738.00
MB 3220	2.000	20	2.400	MH32S	\$4,559.00

B

BORING

Modular Boring Bars

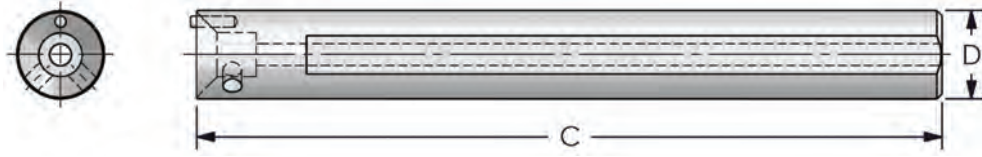

Heavy Metal Shank

6:1 Ratio
Coolant Thru

Designation	D Dia.	C OAL	Min Bore	Set Screw	Price
MBH 1212	.750	12	.930	MH12S	\$493.00
MBH 1612	1.000	12	1.200	MH16S	\$743.00
MBH 2012	1.250	12	1.500	MH20S	\$1,133.00
MBH 2412	1.500	12	1.710	MH24S	\$1,480.00
MBH 2414	1.500	14	1.710	MH24S	\$2,978.00
MBH 2812	1.750	12	2.010	MH28S	\$1,900.00
MBH 2816 *	1.750	16	2.010	MH28S	\$4,276.00
MBH 3212	2.000	12	2.400	MH32S	\$2,366.00
MBH 3218 *	2.000	18	2.400	MH32S	\$5,420.00
MBH 4024 **	2.500	24	2.900	MH32S	\$11,055.00
MBH 4828 **	3.000	28	3.300	MH32S	\$16,692.00

* non-stock item; call for delivery

* 2.5" and 3" bars take 2" heads

B

BORING

MADE IN MICHIGAN

ULTRA-DEX



Hardware
pg: 186



Inserts
pg: 167

Proudly Made in Flushing, MI USA

Steel Boring Bars (Positive)

Modular Head Nomenclature

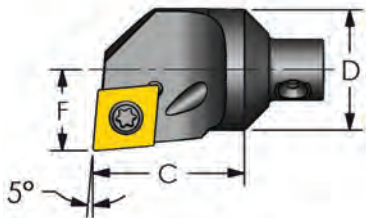
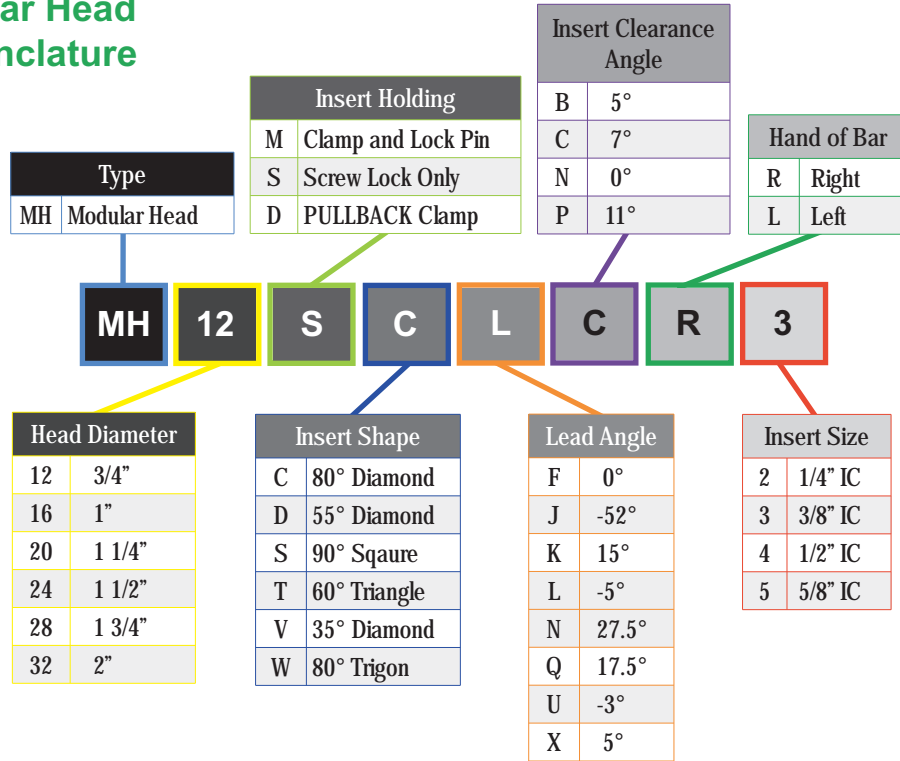

Positive 80° Diamond (-5° Lead)
Coolant Thru

Designation	D Dia.	C OAL	F	Min Bore	Insert	Insert Screw	Key	Price
MH12 SCLCR/L3	.750	.940	.500	.920	CCMT 32.51	MTS-35	T-15	\$82.00
MH16 SCLCR/L3	1.000	1.000	.625	1.185		MTS-35	T-15	\$94.00
MH12 SCLPR/L3	.750	.940	.500	.920	CPMT 32.51	MTS-35	T-15	\$82.00
MH16 SCLPR/L3	1.000	1.000	.625	1.185		MTS-35	T-15	\$94.00
MH20 SCLCR4	1.250	1.300	.765	1.465	CCMT 432	MTS-4	T-20	\$130.00
MH24 SCLCR4	1.500	1.520	.890	1.730		MTS-4	T-20	\$154.00
MH28 SCLCR4	1.750	1.770	1.015	2.000		MTS-4	T-20	\$178.00
MH32 SCLCR4	2.000	2.030	1.281	2.400		MTS-4	T-20	\$213.00

Steel pg: 25 Carbide pg: 49,50 Heavy Metal pg: 68 Chatter-Free pg: 89,92,102

Modular Boring Heads (Positive)

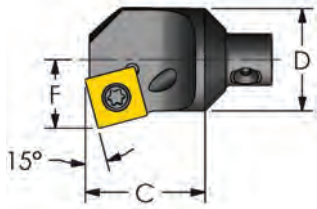

Positive Square
(15° Lead)
Coolant Thru

Designation	D Dia.	C OAL	F	Min Bore	Insert	Insert Screw	Key	Price
MH12 SSKCR3	.750	.875	.500	.920	SCMT 32.51	MTS-35	T-15	\$82.00
MH16 SSKCR4	1.000	.935	.625	1.185	SCMT 432	MTS-4	T-20	\$94.00

Also available in: [Steel pg: 26](#) [Carbide pg: 51](#)

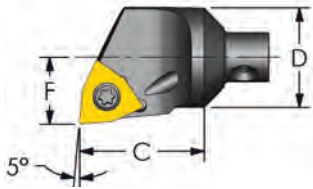

Positive Trigon
(-5° Lead)
Coolant Thru

Designation	D Dia.	C OAL	F	Min Bore	Insert	Insert Screw	Key	Price
MH12 SWLCR/L3	.750	.940	.500	.920	WCMT 32.51	MTS-35	T-15	\$82.00
MH16 SWLCR/L3	1.000	1.000	.625	1.185		MTS-35	T-15	\$94.00

Also available in: [Steel pg: 27](#) [Carbide pg: 53](#) [Heavy Metal pg: 69](#)

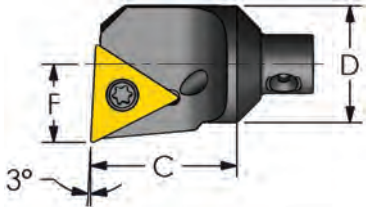

Positive Triangle
(-3° Lead)
Coolant Thru

Designation	D Dia.	C OAL	F	Min Bore	Insert	Insert Screw	Key	Price
MH12 STUCR/L3	.750	.940	.500	.920	TCMT 32.51	MTS-35	T-15	\$82.00
MH16 STUCR/L3	1.000	1.000	.625	1.185		MTS-35	T-15	\$94.00

Also available in: [Steel pg: 30](#) [Carbide pg: 55](#) [Heavy Metal pg: 70](#) [Chatter-Free pg: 92,102](#)

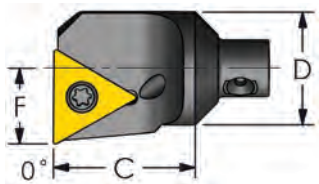

Positive Triangle
(0° Lead)
Coolant Thru

Designation	D Dia.	C OAL	F	Min Bore	Insert	Insert Screw	Key	Price
MH12 STFCCR/L3	.750	.940	.500	.920	TCMT 32.51	MTS-35	T-15	\$82.00
MH16 STFCCR/L3	1.000	1.000	.625	1.185		MTS-35	T-15	\$94.00

Also available in: [Steel pg: 32](#) [Carbide pg: 57](#) [Chatter-Free pg: 93,102](#)

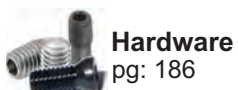

Hardware
pg: 186



Inserts
pg: 167

Proudly Made in Flushing, MI USA

TModular Boring Heads (Positive)

B

BORING

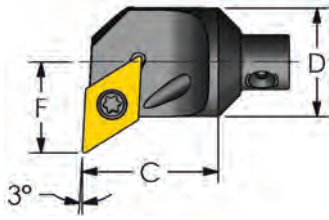

**Positive 55° Diamond
(-3° Lead) Profiling
Coolant Thru**

Designation	D Dia.	C OAL	F	Min Bore	Insert	Insert Screw	Key	Price
MH12 SDUCR/L3	.750	.940	.625	1.050	DCMT 32.51	MTS-35	T-15	\$94.00
MH16 SDUCR/L3	1.000	1.000	.750	1.310		MTS-35	T-15	\$106.00
MH20 SDUCR3-8	1.250	1.300	.800	1.500		MTS-35	T-15	\$130.00
MH20 SDUCR/L3	1.250	1.300	1.000	1.700		MTS-35	T-15	\$130.00
MH24 SDUCR/L3	1.500	1.520	1.120	1.960		MTS-35	T-15	\$154.00
MH28 SDUCR/L3	1.750	1.770	1.250	2.230		MTS-35	T-15	\$178.00
MH32 SDUCR/L3	2.000	2.030	1.375	2.500		MTS-35	T-15	\$213.00

Also available in: Steel pg: 33 Carbide pg: 59 Chatter-Free pg: 89,93,103

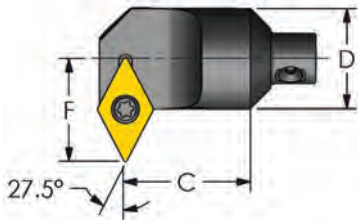

**Positive 55° Diamond
(27.5° Lead) Profiling
Coolant Thru**

Designation	D Dia.	C OAL	F	Min Bore	Insert	Insert Screw	Key	Price
MH12 SDNCR3	.750	.940	.765	1.190	DCMT 32.51	MTS-35	T-15	\$101.00
MH16 SDNCR3	1.000	1.000	.890	1.450		MTS-35	T-15	\$113.00

Also available in: Carbide pg: 59 Chatter-Free pg: 103

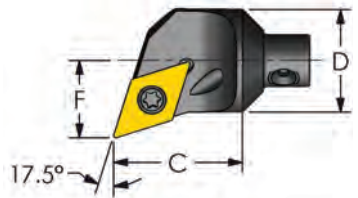

**Positive 55° Diamond
(-17.5° Lead) Profiling
Coolant Thru**

Designation	D Dia.	C OAL	F	Min Bore	Insert	Insert Screw	Key	Price
MH12 SDQCR/L3	.750	.940	.562	1.000	DCMT 32.51	MTS-35	T-15	\$94.00
MH16 SDQCR/L3	1.000	1.000	.625	1.185		MTS-35	T-15	\$106.00

Also available in: Carbide pg: 59

TModular Boring Heads (Positive)

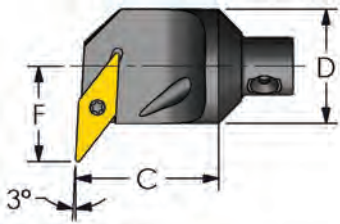

**Positive 35° Diamond
(-3° Lead) Profiling
Coolant Thru**

Designation	D Dia.	C OAL	F	Min Bore	Insert	Insert Screw	Key	Price
MH12 SVUBR/L2	.750	.940	.625	1.045	VBMT 21.51	MTS-2.5L	T-7	\$94.00
MH16 SVUBR/L3	1.000	1.000	.875	1.435	VBMT 331	MTS-3.5L	T-15	\$106.00

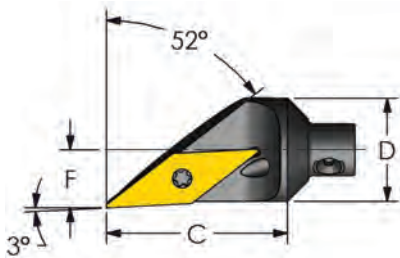

**Positive 35° Diamond
(-52° Lead) Profiling
Coolant Thru**

Designation	D Dia.	C OAL	F	Min Bore	Insert	Insert Screw	Key	Price
MH12 SVJBR/L3	.750	1.315	.421	.840	VBMT 331	MTS-3.5L	T-15	\$94.00
MH16 SVJBR/L3	1.000	1.375	.546	1.110		MTS-3.5L	T-15	\$106.00
MH20 SVJBR/L3	1.250	1.675	.671	1.700		MTS-3.5L	T-15	\$130.00
MH24 SVJBR/L3	1.500	1.895	.796	1.960		MTS-3.5L	T-15	\$154.00
MH28 SVJBR/L3	1.750	2.145	.921	2.230		MTS-3.5L	T-15	\$178.00
MH32 SVJBR/L3	2.000	2.405	1.046	2.500		MTS-3.5L	T-15	\$213.00

Also available in: Steel pg 32 Carbide pg: 60

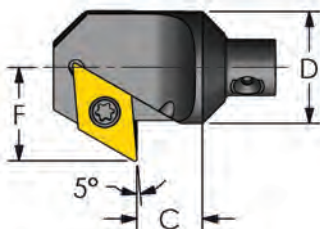

**Positive 55° Diamond
(5° Lead) Back Facing
Coolant Thru**

Designation	D Dia.	C OAL	F	Min Bore	Insert	Insert Screw	Key	Price
MH12 SDXCR/L3	.750	.440	.625	1.050	DCMT 32.51	MTS-35	T-15	\$94.00
MH16 SDXCR/L3	1.000	.525	.750	1.310		MTS-35	T-15	\$106.00

Also available in: Steel pg: 35 Carbide pg: 60 Chatter-Free pg: 103

B

BORING



Hardware
pg: 186



Inserts
pg: 167

Proudly Made in Flushing, MI USA

tModular Boring Heads

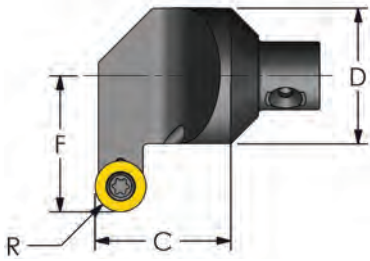

Positive Round
Coolant Thru

Designation	D Dia.	C OAL	F	R	Min Bore	Insert	Screw	Price
MH16 SRNCR/L3	1.000	1.000	1.000	.188	1.560	RCMT 32.5	MTS-35	\$94.00
MH24 SRNCR/L4	1.500	1.520	1.250	.250	2.090	RCMT 43	MTS-4	\$154.00

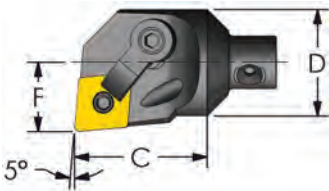

Negative 80° Diamond
(-5° Lead)
Coolant Thru

Designation	D Dia.	C OAL	F	Min Bore	Insert	Shim	Clamp	Clamp Screw	Lock Pin	Price
MH12 MCLNR/L3	.750	.940	.500	.920	CNMG 322	--	CL-7	XNS-36	NL-33	\$106.00
MH16 MCLNR/L3	1.000	1.000	.640	1.200		--	CL-7	XNS-36	NL-33	\$118.00
MH16 MCLNR/L4	1.000	1.000	.640	1.200	CNMG 432	--	CL-20	XNS-47	NL-44	\$118.00
MH20 MCLNR/L4	1.250	1.300	.765	1.470		ICSN-433	CL-20	XNS-47	NL-46	\$154.00
MH24 MCLNR/L4	1.500	1.520	.890	1.730		ICSN-433	CL-20	XNS-47	NL-46	\$178.00
MH28 MCLNR/L4	1.750	1.770	1.015	1.995		ICSN-433	CL-20	XNS-47	NL-46	\$201.00
MH32 MCLNR/L4	2.000	2.030	1.281	2.400		ICSN-433	CL-20	XNS-47	NL-46	\$237.00
MH32 MCLNR/L5	2.000	2.030	1.281	2.400	CNMG 543	ICSN-533	CL-12	XNS-510	NL-58	\$237.00

Also available in: Steel pg: 36 Carbide pg: 61 Chatter-Free pg:94

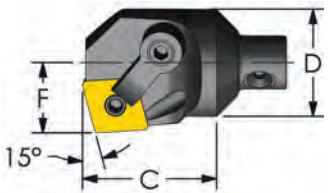

Negative 80° Diamond
(15° Lead)
Coolant Thru

Designation	D Dia.	C OAL	F	Min Bore	Insert	Shim	Clamp	Clamp Screw	Lock Pin	Price
MH12 MCKNR/L3	.750	.875	.490	.910	CNMG 322	--	CL-7	XNS-36	NL-33	\$106.00
MH16 MCKNR/L3	1.000	.935	.630	1.190		--	CL-7	XNS-36	NL-33	\$118.00
MH20 MCKNR/L4	1.250	1.210	.755	1.455	CNMG 432	ICSN-433	CL-20	XNS-47	NL-46	\$154.00
MH24 MCKNR/L4	1.500	1.430	.880	1.720		ICSN-433	CL-20	XNS-47	NL-46	\$178.00
MH28 MCKNR/L4	1.750	1.680	1.005	1.985		ICSN-433	CL-20	XNS-47	NL-46	\$201.00
MH32 MCKNR/L4	2.000	1.940	1.271	2.390		ICSN-433	CL-20	XNS-47	NL-46	\$237.00

B

BORING

Modular Boring Bars (Negative)

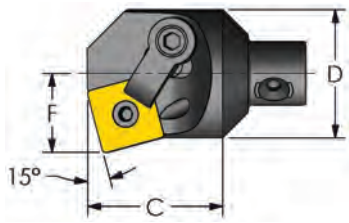

**Negative Square
(15° Lead)
Coolant Thru**

Designation	D Dia.	C OAL	F	Min Bore	Insert	Shim	Clamp	Clamp Screw	Lock Pin	Price
MH16 MSKNR4	1.000	1.060	.630	1.190	SNMG 432	--	CL-20	XNS-47	NL-44	\$118.00
MH20 MSKNR4	1.250	1.210	.755	1.455		ISSN-432	CL-20	XNS-47	NL-46	\$154.00
MH24 MSKNR4	1.500	1.430	.880	1.720		ISSN-432	CL-20	XNS-47	NL-46	\$178.00
MH32 MSKNR4	2.000	1.680	1.271	2.390		ISSN-432	CL-20	XNS-47	NL-46	\$237.00

Also available in: **Chatter-Free pg: 94**

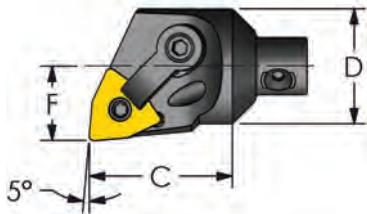

**Negative Trigon
(-5° Lead)
Coolant Thru**

Designation	D Dia.	C OAL	F	Min Bore	Insert	Shim	Clamp	Clamp Screw	Lock Pin	Price
MH12 MWLNR/L3	.750	.940	.500	.920	WNMG 332	--	CL-7	XNS-36	NL-33L	\$106.00
MH16 MWLNR/L3	1.000	1.000	.640	1.200		--	CL-7	XNS-36	NL-33L	\$118.00
MH16 MWLNR/L4	1.000	1.000	.640	1.240	WNMG 432	--	CL-20	XNS-47	NL-44	\$118.00
MH20 MWLNR/L4	1.250	1.300	.765	1.470		IWSN-433	CL-20	XNS-47	NL-46	\$154.00
MH24 MWLNR/L4	1.500	1.520	.890	1.730		IWSN-433	CL-20	XNS-47	NL-46	\$178.00
MH28 MWLNR/L4	1.750	1.770	1.015	1.995		IWSN-433	CL-20	XNS-47	NL-46	\$201.00
MH32 MWLNR/L4	2.000	2.030	1.281	2.400		IWSN-433	CL-20	XNS-47	NL-46	\$237.00

Also available in: **Steel pg: 37** **Carbide pg: 62** **Chatter-Free pg: 95**

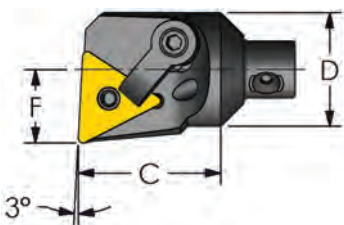

**Negative Triangle
(-3° Lead)
Coolant Thru**

Designation	D Dia.	C OAL	F	Min Bore	Insert	Shim	Clamp	Clamp Screw	Lock Pin	Price
MH12 MTUNR/L3	.750	.940	.500	.920	TNMG 332	--	CL-7	XNS-36	NL-33L	\$106.00
MH16 MTUNR/L3	1.000	1.000	.640	1.200		--	CL-7	XNS-36	NL-33L	\$118.00
MH20 MTUNR/L3	1.250	1.300	.765	1.470		ITSN-323	CL-7	XNS-36	NL-34L	\$154.00
MH24 MTUNR/L3	1.500	1.520	.890	1.470		ITSN-323	CL-7	XNS-36	NL-34L	\$178.00
MH20 MTUNR/L4	1.250	1.300	.765	1.730	TNMG 432	ITSN-433	CL-20	XNS-47	NL-46	\$154.00
MH24 MTUNR/L4	1.500	1.520	.890	1.730		ITSN-433	CL-20	XNS-47	NL-46	\$178.00
MH28 MTUNR/L4	1.750	1.770	1.015	1.995		ITSN-433	CL-20	XNS-47	NL-46	\$201.00
MH32 MTUNR/L4	2.000	2.030	1.281	2.400		ITSN-433	CL-20	XNS-47	NL-46	\$237.00

Also available in: **Chatter-Free pg: 95**



Hardware
pg: 186



Inserts
pg: 167

Proudly Made in Flushing, MI USA

B
BORING



Modular Boring Bars (Negative)

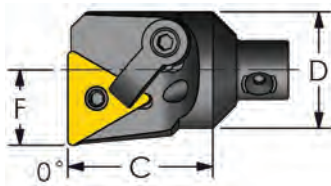

**Negative Triangle
(0° Lead)
Coolant Thru**

Designation	D Dia.	C OAL	F	Min Bore	Insert	Shim	Clamp	Clamp Screw	Lock Pin	Price
MH12 MTFNR/L3	.750	.940	.500	.920	TNMG 332	--	CL-7	XNS-36	NL-33L	\$106.00
MH16 MTFNR/L3	1.000	1.000	.640	1.200		--	CL-7	XNS-36	NL-33L	\$118.00
MH20 MTFNR/L3	1.250	1.300	.765	1.470		ITSN-323	CL-7	XNS-36	NL-34L	\$141.55
MH24 MTFNR/L3	1.500	1.520	.890	1.730		ITSN-323	CL-7	XNS-36	NL-34L	\$178.00
MH20 MTFNR/L4	1.250	1.300	.765	1.470	TNMG 432	ITSN-433	CL-20	XNS-47	NL-46	\$154.00
MH24 MTFNR/L4	1.500	1.520	.890	1.730		ITSN-433	CL-20	XNS-47	NL-46	\$178.00
MH28 MTFNR/L4	1.750	1.770	1.015	1.995		ITSN-433	CL-20	XNS-47	NL-46	\$201.00
MH32 MTFNR/L4	2.000	2.030	1.281	1.995		ITSN-433	CL-20	XNS-47	NL-46	\$237.00

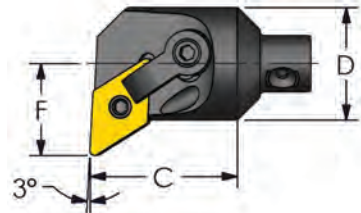

**Negative 55° Diamond
(-3° Lead) Profiling
Coolant Thru**

Designation	D Dia.	C OAL	F	Min Bore	Insert	Shim	Clamp	Clamp Screw	Lock Pin	Price
MH12 MDUNR/L3	.750	.940	.625	1.050	DNMG 332	--	CL-7	XNS-36	NL-33L	\$118.00
MH16 MDUNR/L3	1.000	1.000	.750	1.310		--	CL-7	XNS-36	NL-33L	\$130.00
MH20 MDUNR4-7	1.250	1.300	.775	1.475	DNMG 432	IDSN-433	CL-22	XNS-48	NL-46	\$166.00
MH20 MDUNR/L4	1.250	1.300	1.000	1.700		IDSN-433	CL-22	XNS-48	NL-46	\$166.00
MH24 MDUNR/L4	1.500	1.520	1.120	1.960		IDSN-433	CL-22	XNS-48	NL-46	\$189.00
MH28 MDUNR/L4	1.750	1.770	1.250	2.250		IDSN-433	CL-22	XNS-48	NL-46	\$213.00
MH32 MDUNR/L4	2.000	2.030	1.375	2.500		IDSN-433	CL-22	XNS-48	NL-46	\$249.00

Also available in: Steel pg: 39 Chatter-Free pg: 96

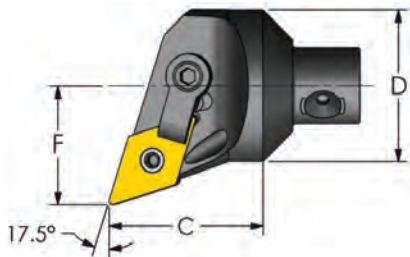

**Negative 55° Diamond
(-17.5° Lead) Profiling
Coolant Thru**

Designation	D Dia.	C OAL	F	Min Bore	Insert	Shim	Clamp	Clamp Screw	Lock Pin	Price
MH20 MDQNR/L4	1.250	1.300	1.000	1.700	DNMG 432	IDSN-433	CL-22	XNS-48	NL-46	\$166.00
MH24 MDQNR/L4	1.500	1.520	1.120	1.960		IDSN-433	CL-22	XNS-48	NL-46	\$189.00
MH28 MDQNR/L4	1.750	1.770	1.250	2.250		IDSN-433	CL-22	XNS-48	NL-46	\$213.00
MH32 MDQNR/L4	2.000	2.030	1.281	2.400		IDSN-433	CL-22	XNS-48	NL-46	\$249.00

Also available in: Steel pg: 40

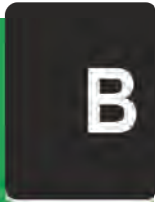

BORING



Modular Boring Heads (Negative)

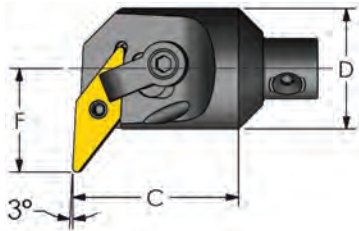

**Negative 35° Diamond
(-3° Lead) Profiling
Coolant Thru**

Designation	D Dia.	C OAL	F	Min Bore	Insert	Shim	Clamp	Clamp Screw	Lock Pin	Price
MH16 MVUNR/L3	1.000	1.300	.875	1.435	VNMG 332	IVSN-322	CL-20	XNS-47	NL-34L	\$130.00
MH20 MVUNR/L3	1.250	1.300	1.000	1.700		IVSN-322	CL-20	XNS-47	NL-34L	\$166.00
MH24 MVUNR/L3	1.500	1.520	1.120	2.000		IVSN-322	CL-20	XNS-47	NL-34L	\$189.00
MH28 MVUNR/L3	1.750	1.770	1.250	2.250		IVSN-322	CL-20	XNS-47	NL-34L	\$213.00
MH32 MVUNR/L3	2.000	2.030	1.375	2.500		IVSN-322	CL-20	XNS-47	NL-34L	\$249.00
MH28 MVUNR/L4	1.750	1.770	1.250	2.250	VNMG 432	IVSN-432	CL-22	XNS-48	NL-46	\$213.00
MH32 MVUNR/L4	2.000	2.030	1.375	2.500		IVSN-432	CL-22	XNS-48	NL-46	\$249.00

Also available in: Carbide -pg: 62 Steel pg: 40 Chatter-Free pg:96

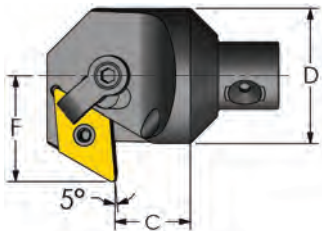

**Negative 55° Diamond
(5° Lead) Back Facing
Coolant Thru**

Designation	D Dia.	C OAL	F	Min Bore	Insert	Shim	Clamp	Clamp Screw	Lock Pin	Price
MH20 MDXNR/L4	1.250	.700	1.000	1.700	DNMG 432	IDSN-433	CL-22	XNS-48	NL-46	\$178.00
MH24 MDXNR/L4	1.500	.650	1.120	1.960		IDSN-433	CL-22	XNS-48	NL-46	\$201.00
MH28 MDXNR/L4	1.750	.780	1.250	2.250		IDSN-433	CL-22	XNS-48	NL-46	\$225.00
MH32 MDXNR/L4	2.000	.780	1.500	2.620		IDSN-433	CL-22	XNS-48	NL-46	\$261.00

**MICHIGAN
MADE**



Hardware
pg: 186



Inserts
pg: 167

Proudly Made in Flushing, MI USA

Modular Boring Heads (Negative)

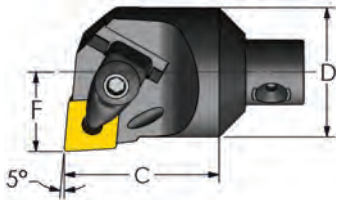

PULLBACK Clamp
 Negative 80° Diamond
 (-5° Lead)
 Coolant Thru

Designation	D Dia.	C OAL	F	Min Bore	Insert	Shim	Shim Screw	Clamp Assy.	Price
MH16 DCLNR4	1.000	1.500	.640	1.200	CNMG 432	--	--	PB4-CA	\$211.00
MH20 DCLNR4	1.250	1.500	.765	1.470		ICSN-433	PB4-SS		\$247.00
MH24 DCLNR4	1.500	1.520	.890	1.730		ICSN-433	PB4-SS		\$300.00
MH28 DCLNR4	1.750	1.770	1.015	1.995		ICSN-433	PB4-SS		\$324.00
MH32 DCLNR4	2.000	2.030	1.281	2.400		ICSN-433	PB4-SS		\$360.00

Also available in: [Steel pg: 37](#) [Carbide pg: 61](#) [Chatter-Free pg: 104](#)

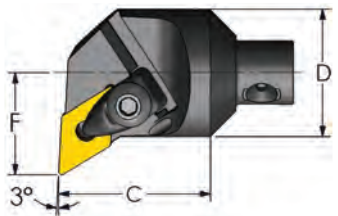

PULLBACK Clamp
 Negative 55° Diamond
 (-3° Lead)
 Coolant Thru

Designation	D Dia.	C OAL	F	Min Bore	Insert	Shim	Shim Screw	Clamp Assy.	Price
MH20 DDUNR4	1.250	1.500	1.000	1.700	DNMG 432	IDSN-433	PB4-SS	PB4-CA	\$247.00
MH24 DDUNR4	1.500	1.520	1.120	1.960		IDSN-433	PB4-SS		\$300.00
MH28 DDUNR4	1.750	1.770	1.250	2.250		IDSN-433	PB4-SS		\$324.00
MH32 DDUNR4	2.000	2.030	1.375	2.500		IDSN-433	PB4-SS		\$360.00

Also available in: [Steel pg: 39](#) [Carbide pg: 62](#) [Chatter-Free pg: 104](#)

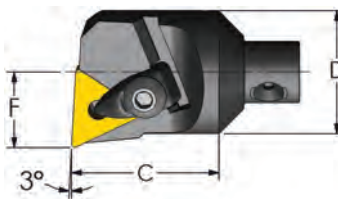

PULLBACK Clamp
 Negative Triangle
 (-3° Lead)
 Coolant Thru

Designation	D Dia.	C OAL	F	Min Bore	Insert	Shim	Shim Screw	Clamp Assy.	Price
MH20 DTUNR4	1.250	1.500	.765	1.470	TNMG 432	ITSN-433	PB4-SS	PB4-CA	\$247.00
MH24 DTUNR4	1.500	1.520	.890	1.730		ITSN-433	PB4-SS		\$300.00
MH28 DTUNR4	1.750	1.770	1.015	1.995		ITSN-433	PB4-SS		\$324.00
MH32 DTUNR4	2.000	2.030	1.281	2.400		ITSN-433	PB4-SS		\$360.00

Also available in: [Steel pg: 38](#) [Chatter-Free pg: 104](#)



BORING

Modular Boring Heads (Negative)

Threading / Grooving Modular Head Nomenclature

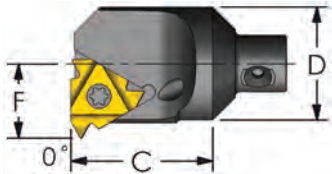
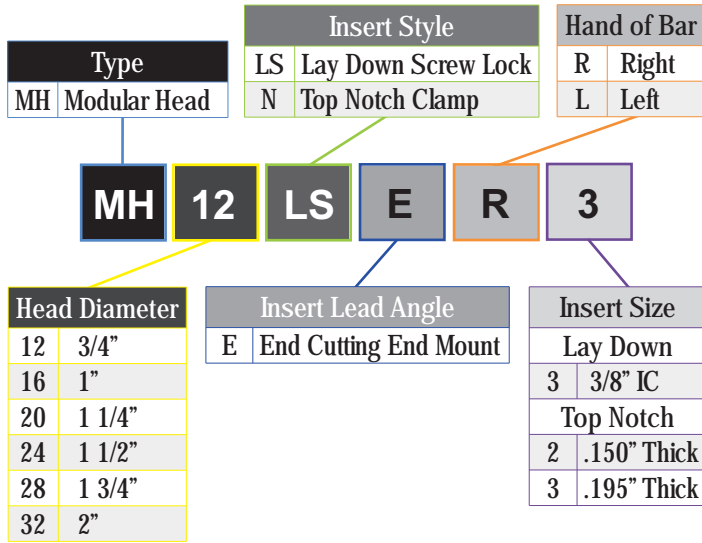

Threading / Grooving
Laydown
Coolant Thru

Designation Right Hand	D Dia.	C OAL	F	Min Bore	Insert	Insert Screw	Anvil Screw	Anvil	Price
MH12 LSER3	.750	.940	.510	.930	3IR	MTS-35	--	--	\$106.00
MH16 LSER3	1.000	1.000	.650	1.210		SA3T	SY3T	YI3	\$130.00
MH20 LSER3	1.250	1.300	.770	1.470		SA3T	SY3T	YI3	\$166.00
MH24 LSER3	1.500	1.520	.900	1.740		SA3T	SY3T	YI3	\$189.00
MH28 LSER3	1.750	1.770	1.090	2.070		SA3T	SY3T	YI3	\$213.00
MH32 LSER3	2.000	2.030	1.281	2.400		SA3T	SY3T	YI3	\$249.00

Designation Left Hand	D Dia.	C OAL	F	Min Bore	Insert	Insert Screw	Anvil Screw	Anvil	Price
MH12 LSEL3	.750	.940	.510	.930	3IL	MTS-35	--	--	\$106.00
MH16 LSEL3	1.000	1.000	.650	1.210		SA3T	SY3T	YE3	\$130.00
MH20 LSEL3	1.250	1.300	.770	1.470		SA3T	SY3T	YE3	\$166.00
MH24 LSEL3	1.500	1.520	.900	1.740		SA3T	SY3T	YE3	\$189.00
MH28 LSEL3	1.750	1.770	1.090	2.070		SA3T	SY3T	YE3	\$213.00
MH32 LSEL3	2.000	2.030	1.281	2.400		SA3T	SY3T	YE3	\$249.00

Also available in: Steel pg: 41 Carbide pg: 63 Chatter-Free pg: 89,97,106



Hardware
pg: 186



Inserts
pg: 167

Proudly Made in Flushing, MI USA

B
BORING

PULLBACK Modular Boring Heads

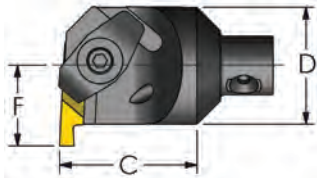

Threading / Grooving
 Top Notch
 Coolant Thru

B

BORING

Designation Right Hand	D Dia.	C OAL	F	Min Bore	Insert	Clamp	Clamp Screw	Price
MH12 NER2	.750	.920	.562	1.120	NG 2L	CM-75	6-32	\$118.00
MH16 NER2	1.000	1.180	.688	1.380		CM-75	6-32	\$130.00
MH16 NER3	1.000	1.180	.688	1.380	NG 3L	CM-73	10-32	\$130.00
MH20 NER3	1.250	1.300	.875	1.750		CM-73	10-32	\$168.00
MH24 NER3	1.500	1.520	1.000	2.000		CM-73	10-32	\$194.00
MH28 NER3	1.750	1.770	1.125	2.250		CM-73	10-32	\$220.00
MH32 NER3	2.000	2.030	1.250	2.500		CM-73	10-32	\$260.00

Designation	D Dia.	C OAL	F	Min Bore	Insert	Clamp	Clamp Screw	Price
MH12 NEL2	.750	.920	.562	1.120	NG 2R	CM-74	6-32	\$118.00
MH16 NEL2	1.000	1.180	.688	1.380		CM-74	6-32	\$130.00
MH16 NEL3	1.000	1.180	.688	1.380	NG 3R	CM-72	10-32	\$130.00
MH20 NEL3	1.250	1.300	.875	1.750		CM-72	10-32	\$168.00
MH24 NEL3	1.500	1.520	1.000	2.000		CM-72	10-32	\$194.00
MH28 NEL3	1.750	1.770	1.125	2.250		CM-72	10-32	\$220.00
MH32 NEL3	2.000	2.030	1.250	2.500		CM-72	10-32	\$260.00

Steel pg: 41 Carbide pg: 63 Chatter-Free pg: 98,106

CUSTOM MODULAR HEADS AVAILABLE!

CALL: 810-638-5388

Chatter-Free Boring Bars & Heads

CHATTER-FREE BORING BARS

Tunable Internal Dampening Technology...

provides optimal dynamic stability yielding significant increases in machining performance. Most importantly, the bars pay for themselves quickly by increasing speed and precision. Additionally, you can leave Chatter-Free Tooling "CFT" in the machine and use it for deep or shallow bore applications, thus reducing changeover and setup time.

5:1 Ratio up to 14:1 Ratio

- Fully tunable boring bar (arrives pre-tuned)
- Labeled dial for ease of tuning
- Quick setup flat located on connection end of bar
- Solves difficult deep boring applications
- Increase surface finish
- Increase output by more aggressive cutting
- Increase tool life from reduced vibration
- Multiple head configurations

**MADE IN
USA**



B

BORING

Chatter-Free DIRECTORY / Proper Holding

- p89 SOLID Bars
p91 Modular Head Nomenclature



STANDARD (Pin) Connection

- p87 Modular Bars
p90 "CFT Style" Modular Bars
p92 Modular Heads



SERRATED Connection

- p100 Modular Bars
p99 "CFT Style" Modular Bars
p102 Modular Heads

B

BORING



Proper Workholding Using the Split Collar System

To assure the best rigidity of the boring bar, the split collar system is the best holder. This process is achieved by locking the bar 360° on the diameter.

Other workholding, like set-screws, damage the structural surface of the bar and are NOT recommended.



For more information download the Chatter-Free brochure or request a physical copy at www.ultradexusa.com

STANDARD Chatter-Free Boring Bars (English)

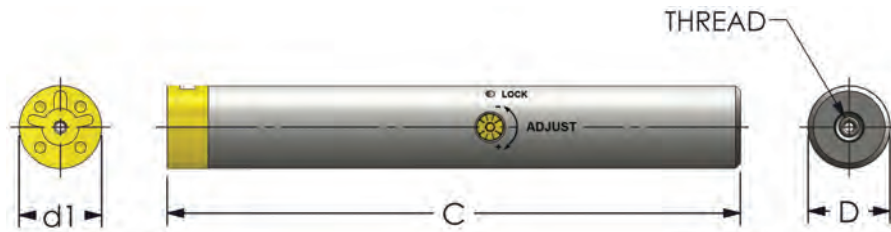

Modular Chatter-Free Bars

Coolant Thru

Designation	D Dia.	d1 (Coupling)	C OAL	Min Bore	Head Bolts	Thread	Price
5:1 Ratio							
CFT B1500-9	1.500	1.500	9	1.760	10-24 HB	1/8-27 NPT	\$1,158.00
CFT B2000-12	2.000	2.000	12	2.400	1/4-20 HB	1/8-27 NPT	\$1,407.00
CFT B2500-16	2.500	2.500	16	2.800	5/16-18 HB	1/8-27 NPT	\$1,914.00
7:1 Ratio							
CFT B1000-10	1.000	1.000	10	1.200	8-32 HB	1/8-27 NPT	\$889.00
CFT B1250-12	1.250	1.250	12	1.470	10-24 HB	1/8-27 NPT	\$993.00
CFT B1500-15	1.500	1.500	15	1.760	10-24 HB	1/8-27 NPT	\$1,158.00
CFT B1750-18	1.750	1.750	18	2.010	1/4-20 HB	1/8-27 NPT	\$1,328.00
CFT B2000-20	2.000	2.000	20	2.400	1/4-20 HB	1/8-27 NPT	\$1,407.00
CFT B2500-27	2.500	2.500	27	2.800	5/16-18 HB	1/4-18 NPT	\$1,914.00
CFT B3000-31	3.000	2.500	31	3.525	5/16-18 HB	1/4-18 NPT	\$2,304.00
10:1 Ratio							
CFT B1000-14	1.000	1.000	14	1.200	8-32 HB	1/8-27 NPT	\$1,716.00
CFT B1250-16	1.250	1.250	16	1.470	10-24 HB	1/8-27 NPT	\$1,870.00
CFT B1500-19	1.500	1.500	19	1.760	10-24 HB	1/8-27 NPT	\$1,919.00
CFT B1750-23	1.750	1.750	23	2.010	1/4-20 HB	1/8-27 NPT	\$2,024.00
CFT B2000-26	2.000	2.000	26	2.400	1/4-20 HB	1/8-27 NPT	\$2,134.00
CFT B2500-33	2.500	2.500	33	2.800	5/16-18 HB	1/4-18 NPT	\$2,910.00
CFT B3000-40	3.000	2.500	40	3.525	5/16-18 HB	1/4-18 NPT	\$4,222.00
CFT B4000-50	4.000	2.500	50	4.350	5/16-18 HB	1/4-18 NPT	\$7,466.00
12:1 Ratio							
CFT B1000-16	1.000	1.000	16	1.200	8-32 HB	--	\$3,805.00
CFT B1250-18	1.250	1.250	18	1.470	10-24 HB	--	\$4,710.00
CFT B1500-22	1.500	1.500	22	1.760	10-24 HB	--	\$5,807.00
CFT B1750-25	1.750	1.750	25	2.010	1/4-20 HB	--	\$7,098.00
CFT B2000-29	2.000	2.000	29	2.400	1/4-20 HB	--	\$8,904.00
14:1 Ratio							
CFT B1000-18	1.000	1.000	18	1.200	8-32 HB	--	\$7,420.00
CFT B1250-21	1.250	1.250	21	1.470	10-24 HB	--	\$8,843.00
CFT B1500-25	1.500	1.500	25	1.760	10-24 HB	--	\$10,263.00
CFT B1750-29	1.750	1.750	29	2.010	1/4-20 HB	--	\$11,940.00
CFT B2000-33	2.000	2.000	33	2.400	1/4-20 HB	--	\$15,297.00



Hardware
pg: 186



Inserts
pg: 167

Proudly Made in Flushing, MI USA

STANDARD Chatter-Free Boring Bars (Metric)

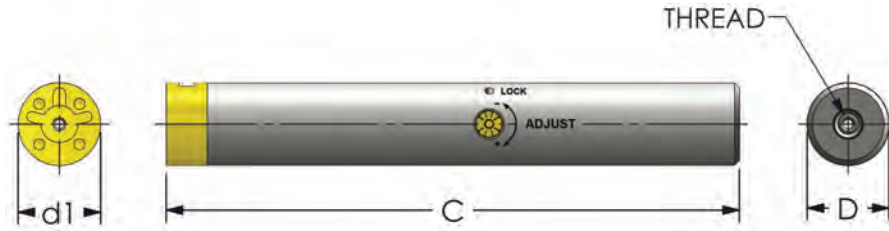

Modular Chatter-Free Bars

Coolant Thru

Designation	D Dia.	d1 (Coupling)	C OAL	Min Bore	Head Bolts	Thread	Price
7:1 Ratio							
CFT B25MM-250	25mm	1.000	250mm	1.200	8-32 HB	1/8-27 NPT	\$889.00
CFT B32MM-320	32mm	1.250	320mm	1.470	10-24 HB	1/8-27 NPT	\$993.00
CFT B40MM-400	40mm	1.500	400mm	1.760	10-24 HB	1/8-27 NPT	\$1,158.00
CFT B50MM-500	50mm	2.000	500mm	2.400	1/4-20 HB	1/8-27 NPT	\$1,407.00
CFT B60MM-600	60mm	2.000	600mm	2.830	1/4-20 HB	1/8-27 NPT	\$1,914.00
10:1 Ratio							
CFT B25MM-325	25mm	1.000	325mm	1.200	8-32 HB	1/8-27 NPT	\$1,716.00
CFT B32MM-416	32mm	1.250	416mm	1.470	10-24 HB	1/8-27 NPT	\$1,870.00
CFT B40MM-520	40mm	1.500	520mm	1.760	10-24 HB	1/8-27 NPT	\$1,919.00
CFT B50MM-650	50mm	2.000	650mm	2.400	1/4-20 HB	1/8-27 NPT	\$2,134.00
CFT B60MM-780	60mm	2.000	780mm	2.830	1/4-20 HB	1/8-27 NPT	\$2,910.00
12:1 Ratio							
CFT B32MM-480	32mm	1.250	480mm	1.470	10-24 HB	--	\$4,710.00
CFT B40MM-600	40mm	1.500	600mm	1.760	10-24 HB	--	\$5,807.00
CFT B50MM-750	50mm	2.000	750mm	2.400	1/4-20 HB	--	\$8,904.00
14:1 Ratio							
CFT B32MM-544	32mm	1.250	544mm	1.470	10-24 HB	--	\$8,843.00
CFT B40MM-680	40mm	1.500	680mm	1.760	10-24 HB	--	\$10,263.00
CFT B50MM-850	50mm	2.000	850mm	2.400	1/4-20 HB	--	\$15,297.00

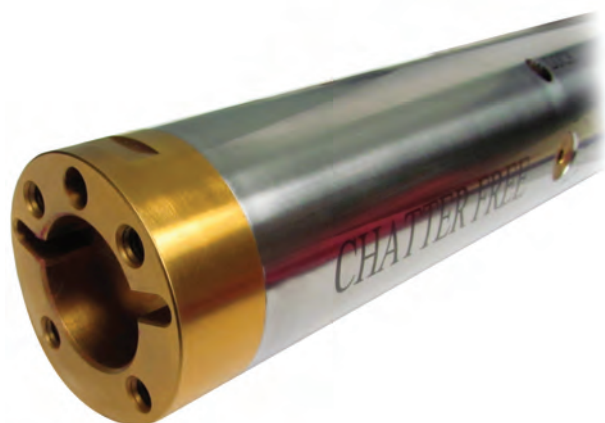

B

BORING

SOLID Chatter-Free Boring Bars



SOLID Positive 80° Diamond (-5° Lead)

8:1 Ratio
Coolant Thru

Designation	D Dia.	C OAL	F	Min Bore	Insert	Insert Screw	Key	Price
D08R SCLCR2	.500	8	.281	.580	CCMT 21.51	MTS-255	T-7	\$653.00
D10X SCLCR3	.625	9	.406	.770	CCMT 32.51	MTS-35	T-15	\$708.00
D12S SCLCR3	.750	10	.500	.930		MTS-35	T-15	\$763.00

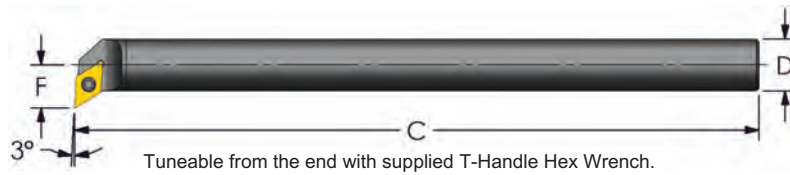

SOLID Positive 55° Diamond (-3° Lead)

8:1 Ratio
Coolant Thru

Designation	D Dia.	C OAL	F	Min Bore	Insert	Insert Screw	Key	Price
D08R SDUCR2	.500	8	.437	.730	DCMT 21.51	MTS-255	T-7	\$653.00
D10X SDUCR2	.625	9	.500	.850		MTS-255	T-7	\$708.00
D12S SDUCR3	.750	10	.625	1.050	DCMT 32.51	MTS-35	T-15	\$763.00

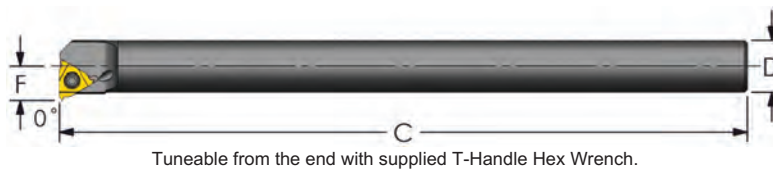

SOLID Threading/Grooving Laydown

8:1 Ratio
Coolant Thru

Designation	D Dia.	C OAL	F	Min Bore	Insert	Insert Screw	Price
D12S LSER3	.750	10	.510	.935	3IR	MTS-35	\$763.00

B

BORING

ULTRA-DEX



Hardware
pg: 186



Inserts
pg: 167

Proudly Made in Flushing, MI USA

STANDARD "CFT Style" Boring Bars



In addition to our Chatter-Free bars, we offer a solid carbide or steel alternative with the same connection! These solid bars fit all heads following this page with the ending "-CFT" designation.

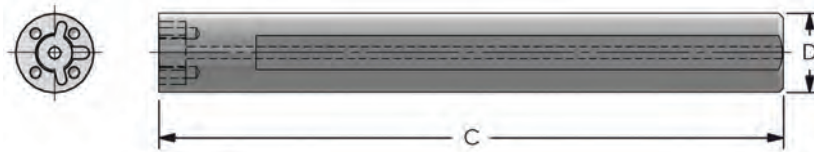

B

BORING

Steel Shank

4:1 Ratio
Coolant Thru

Designation	D Dia.	C OAL	Min Bore	Head Bolts	Price
A1000-12	1.000	12	1.200	8-32	\$176.00
A1250-14	1.250	14	1.500	10-24	\$227.00
A1500-14	1.500	14	1.710	10-24	\$251.00
A1750-16	1.750	16	2.010	1/4-20	\$300.00
A2000-20	2.000	20	2.400	1/4-20	\$395.00
A2500-12	2.500	12	2.900	5/16-18	\$452.00
A2500-24	2.500	24	2.900	5/16-18	\$646.00
A3000-18 *	3.000	18	3.525	5/16-18	\$742.00

* 3" bar takes 2.5" head

Carbide Shank

8:1 Ratio
Coolant Thru

Designation	D Dia.	C OAL	Min Bore	Head Bolts	Price
E1000-12	1.000	12	1.200	8-32	\$1,025.00
E1250-14	1.250	14	1.500	10-24	\$1,787.00
E1500-14	1.500	14	1.710	10-24	\$2,116.00
E1750-16	1.750	16	2.010	1/4-20	\$3,173.00
E2000-20	2.000	20	2.400	1/4-20	\$4,702.00

Chatter-Free Modular Boring Bar NOMENCLATURE

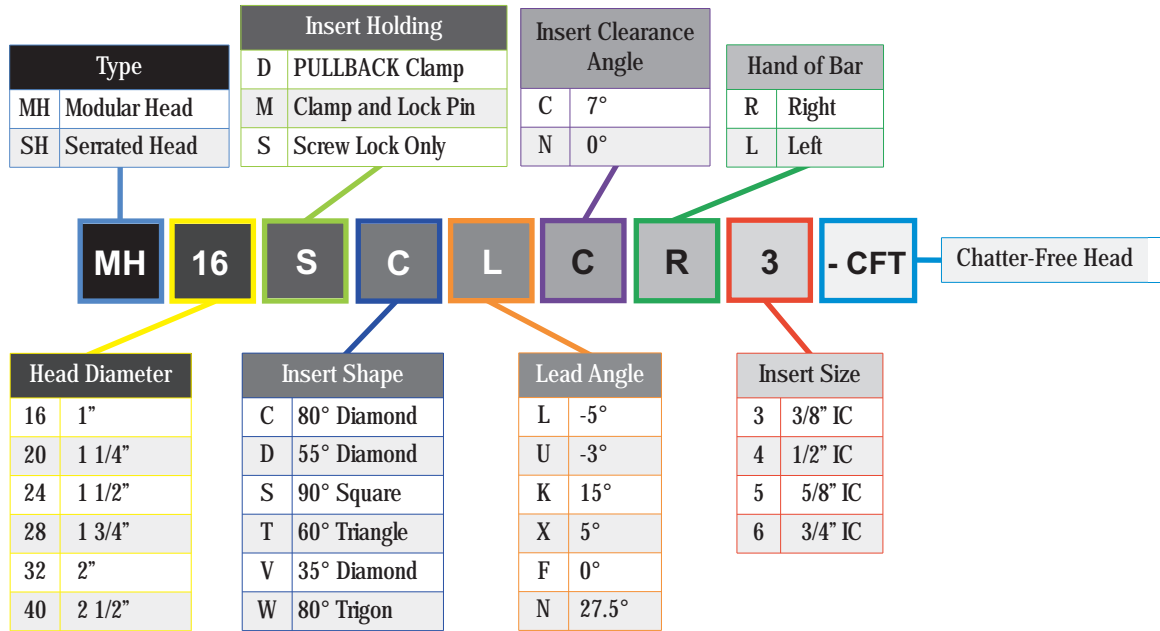

B
BORING

Threading / Grooving

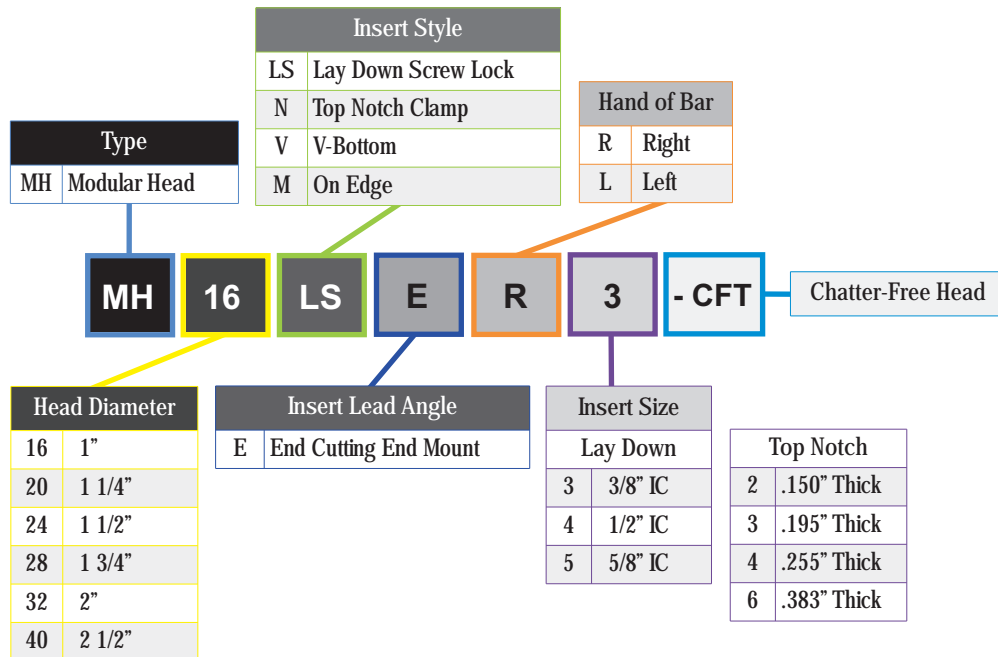

Hardware
pg: 186



Inserts
pg: 167



Proudly Made in Flushing, MI USA

STANDARD Chatter-Free Heads (Positive)

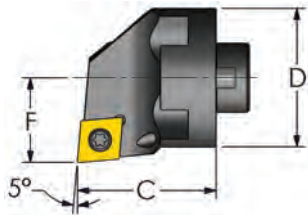

**Positive 80° Diamond
(-5° Lead)
Coolant Thru**

Designation	D Dia.	C OAL	F	Min Bore	Insert	Insert Screw	Key	Price
MH16 SCLCR/L3-CFT	1.000	.790	.625	1.200	CCMT 32.51	MTS-35	T-15	\$169.00
MH20 SCLCR/L3-CFT	1.250	1.250	.765	1.470		MTS-35	T-15	\$174.00
MH24 SCLCR/L3-CFT	1.500	1.250	.890	1.760		MTS-35	T-15	\$182.00
MH28 SCLCR/L3-CFT	1.750	1.250	1.015	2.030		MTS-35	T-15	\$192.00
MH24 SCLCR4-CFT	1.500	1.250	.890	1.760	CCMT 432	MTS-4	T-20	\$182.00
MH28 SCLCR4-CFT	1.750	1.250	1.015	2.030		MTS-4	T-20	\$192.00
MH32 SCLCR/L4-CFT	2.000	1.625	1.281	2.400		MTS-4	T-20	\$215.00
MH40 SCLCR/L4-CFT	2.500	1.625	1.500	2.800		MTS-4	T-20	\$230.00

Steel pg: 25

Carbide pg: 49,50

Heavy Metal pg: 68

Modular pg: 74

Serrated Chatter Free pg: 102

B

BORING

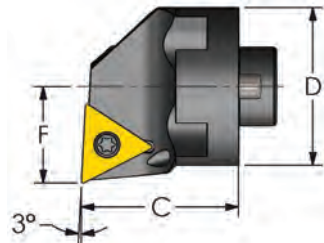

**Positive Triangle
(-3° Lead)
Coolant Thru**

Designation	D Dia.	C OAL	F	Min Bore	Insert	Insert Screw	Key	Price
MH16 STUCR/L2-CFT	1.000	.790	.625	1.200	TCMT 21.51	MTS-255	T-7	\$169.00
MH20 STUCR/L3-CFT	1.250	1.250	.765	1.470	TCMT 32.51	MTS-35	T-15	\$174.00
MH24 STUCR/L3-CFT	1.500	1.250	.890	1.760		MTS-35	T-15	\$182.00
MH28 STUCR/L3-CFT	1.750	1.250	1.015	2.030		MTS-35	T-15	\$192.00
MH32 STUCR/L3-CFT	2.000	1.625	1.281	2.400		MTS-35	T-15	\$215.00
MH40 STUCR/L3-CFT	2.500	1.625	1.500	2.800		MTS-35	T-15	\$230.00

Also available in:

Steel pg: 30

Carbide pg: 55

Heavy Metal pg: 70

Modular pg: 75



STANDARD Chatter-Free Heads (Positive)

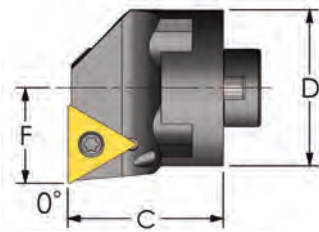

**Positive Triangle
(0° Lead)
Coolant Thru**

Designation Right Hand	D Dia.	C OAL	F	Min Bore	Insert	Insert Screw	Key	Price
MH16 STFCR/L2-CFT	1.000	.790	.625	1.200	TCMT 21.51	MTS-255	T-7	\$169.00
MH20 STFCR/L3-CFT	1.250	1.250	.765	1.470	TCMT 32.51	MTS-35	T-15	\$174.00
MH24 STFCR/L3-CFT	1.500	1.250	.890	1.760		MTS-35	T-15	\$182.00
MH28 STFCR/L3-CFT	1.750	1.250	1.015	2.030		MTS-35	T-15	\$192.00
MH32 STFCR/L3-CFT	2.000	1.625	1.281	2.400		MTS-35	T-15	\$215.00
MH40 STFCR/L3-CFT	2.500	1.625	1.500	2.800		MTS-35	T-15	\$230.00

Also available in: Steel pg: 32 Carbide pg: 57 Modular pg: 75 Serrated Chatter-Free pg: 102

B

BORING

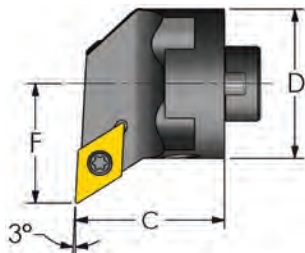

**Positive 55° Diamond
(-3° Lead) Profiling
Coolant Thru**

Designation Right Hand	D Dia.	C OAL	F	Min Bore	Insert	Insert Screw	Key	Price
MH16 SDUCR/L3-CFT	1.000	.790	.750	1.300	DCMT 32.51	MTS-35	T-15	\$169.00
MH20 SDUCR/L3-CFT	1.250	1.250	1.000	1.675		MTS-35	T-15	\$174.00
MH24 SDUCR/L3-CFT	1.500	1.250	1.120	1.920		MTS-35	T-15	\$182.00
MH28 SDUCR/L3-CFT	1.750	1.250	1.250	2.175		MTS-35	T-15	\$192.00
MH32 SDUCR/L3-CFT	2.000	1.625	1.375	2.425		MTS-35	T-15	\$215.00
MH40 SDUCR/L3-CFT	2.500	1.625	1.500	2.800		MTS-35	T-15	\$230.00

Also available in: Steel pg: 33 Carbide pg: 59 Modular pg: 76 Serrated Chatter-Free pg: 103



Hardware
pg: 186



Inserts
pg: 167

Proudly Made in Flushing, MI USA

STANDARD Chatter-Free Heads (Negative)

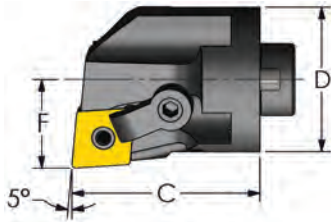

**Negative 80° Diamond
(-5° Lead)
Coolant Thru**

Designation	D Dia.	C OAL	F	Min Bore	Insert	Shim	Clamp	Clamp Screw	Lock Pin	Price
MH16 MCLNR/L4-CFT	1.000	1.625	.640	1.200	CNMG 432	--	CL-20	XNS-47	NL-44	\$180.00
MH20 MCLNR/L4-CFT	1.250	1.625	.765	1.470		ICSN-433	CL-20	XNS-47	NL-46	\$185.00
MH24 MCLNR/L4-CFT	1.500	1.625	.890	1.760		ICSN-433	CL-20	XNS-47	NL-46	\$196.00
MH28 MCLNR/L4-CFT	1.750	1.625	1.015	2.010		ICSN-433	CL-20	XNS-47	NL-46	\$202.00
MH32 MCLNR/L4-CFT	2.000	1.625	1.281	2.400		ICSN-433	CL-20	XNS-47	NL-46	\$229.00
MH40 MCLNR/L4-CFT	2.500	1.625	1.531	2.980		ICSN-433	CL-20	XNS-47	NL-46	\$247.00
MH24 MCLNR/L5-CFT	1.500	1.625	.890	1.760	CNMG 543	--	CL-20	XNS-47	NL-56	\$196.00
MH32 MCLNR/L5-CFT	2.000	1.625	1.281	2.400		ICSN-533	CL-12	XNS-510	NL-58	\$229.00
MH40 MCLNR/L5-CFT	2.500	1.625	1.531	2.980		ICSN-533	CL-12	XNS-510	NL-58	\$247.00
MH32 MCLNR/L6-CFT	2.000	1.625	1.281	2.400	CNMG 643	ICSN-633	CL-12	XNS-59	NL-68	\$229.00
MH40 MCLNR/L6-CFT	2.500	1.625	1.531	3.030		ICSN-633	CL-12	XNS-59	NL-68	\$247.00

Also available in: Steel pg: 36 Carbide pg: 61 Modular pg: 78

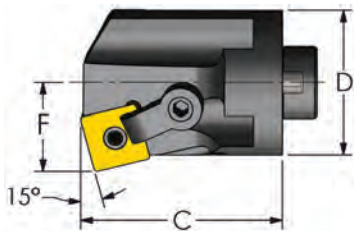

**Negative Square
(15° Lead)
Coolant Thru**

Designation	D Dia.	C OAL	F	Min Bore	Insert	Shim	Clamp	Clamp Screw	Lock Pin	Price
MH20 MSKNR/L4-CFT	1.250	1.744	.765	1.470	SNMG 432	ISSN-433	CL-20	XNS-47	NL-46	\$185.00
MH24 MSKNR/L4-CFT	1.500	1.744	.890	1.760		ISSN-433	CL-20	XNS-47	NL-46	\$196.00
MH28 MSKNR/L4-CFT	1.750	1.744	1.015	2.010		ISSN-433	CL-20	XNS-47	NL-46	\$202.00
MH32 MSKNR/L4-CFT	2.000	1.744	1.281	2.400		ISSN-433	CL-20	XNS-47	NL-46	\$229.00
MH40 MSKNR/L4-CFT	2.500	1.804	1.531	3.030		ISSN-433	CL-20	XNS-47	NL-46	\$247.00
MH32 MSKNR/L5-CFT	2.000	1.744	1.281	2.400	SNMG 543	ISSN-533	CL-12	XNS-510	NL-58	\$229.00
MH40 MSKNR/L5-CFT	2.500	1.804	1.531	3.030		ISSN-533	CL-12	XNS-510	NL-58	\$247.00
MH32 MSKNR/L6-CFT	2.000	1.744	1.281	2.400	SNMG 643	ISSN-633	CL-12	XNS-510	NL-68	\$229.00
MH40 MSKNR/L6-CFT	2.500	1.804	1.531	3.030		ISSN-633	CL-12	XNS-510	NL-68	\$247.00

Also available in: Modular pg: 79

B

BORING

STANDARD Chatter-Free Heads (Negative)

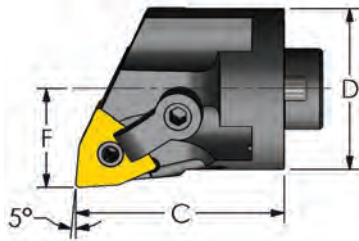

**Negative Trigon
(-5° Lead)
Coolant Thru**

Designation	D Dia.	C OAL	F	Min Bore	Insert	Shim	Clamp	Clamp Screw	Lock Pin	Price
MH16 MWLNR/L4-CFT	1.000	1.625	.640	1.200	WNMG 432	--	CL-20	XNS-47	NL-44	\$180.00
MH20 MWLNR/L4-CFT	1.250	1.625	.765	1.470		IWSN-433	CL-20	XNS-47	NL-46	\$185.00
MH24 MWLNR/L4-CFT	1.500	1.625	.890	1.760		IWSN-433	CL-20	XNS-47	NL-46	\$196.00
MH28 MWLNR/L4-CFT	1.750	1.625	1.015	2.010		IWSN-433	CL-20	XNS-47	NL-46	\$202.00
MH32 MWLNR/L4-CFT	2.000	1.625	1.281	2.400		IWSN-433	CL-20	XNS-47	NL-46	\$229.00
MH40 MWLNR/L4-CFT	2.500	1.625	1.500	2.980		IWSN-433	CL-20	XNS-47	NL-46	\$247.00

Also available in: Steel pg: 37 Carbide pg: 62 Modular pg: 79

B

BORING

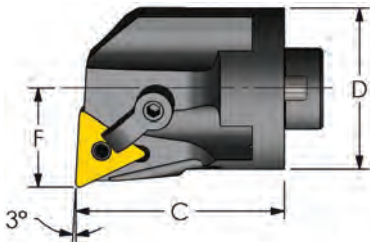

**Negative Triangle
(-3° Lead)
Coolant Thru**

Designation Right Hand	D Dia.	C OAL	F	Min Bore	Insert	Shim	Clamp	Clamp Screw	Lock Pin	Price
MH16 MTUNR/L3-CFT	1.000	1.625	.640	1.200	TNMG 332	--	CL-7	XNS-36	NL-33L	\$180.00
MH20 MTUNR/L3-CFT	1.250	1.625	.765	1.470		ITSN-323	CL-7	XNS-36	NL-34L	\$185.00
MH24 MTUNR/L4-CFT	1.500	1.625	.890	1.760	TNMG 432	ITSN-433	CL-20	XNS-47	NL-46	\$196.00
MH28 MTUNR/L4-CFT	1.750	1.625	1.015	2.010		ITSN-433	CL-20	XNS-47	NL-46	\$202.00
MH32 MTUNR/L4-CFT	2.000	1.625	1.281	2.400		ITSN-433	CL-20	XNS-47	NL-46	\$229.00
MH40 MTUNR/L4-CFT	2.500	1.625	1.531	2.900		ITSN-433	CL-20	XNS-47	NL-46	\$247.00

Also available in: Modular pg: 79



Hardware
pg: 186



Inserts
pg: 167



Proudly Made in Flushing, MI USA

STANDARD Chatter-Free Heads (Negative)

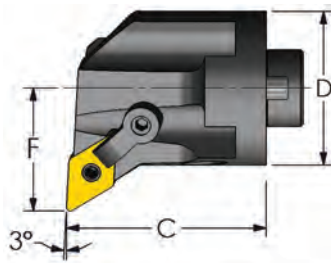

**Negative 55° Diamond
(-3° Lead)
Coolant Thru**

Designation Right Hand	D Dia.	C OAL	F	Min Bore	Insert	Shim	Clamp	Clamp Screw	Lock Pin	Price
MH16 MDUNR/L3-CFT	1.000	1.625	.750	1.300	DNMG 332	--	CL-7	XNS-36	NL-33L	\$180.00
MH20 MDUNR/L3-CFT	1.250	1.625	1.000	1.705		IDSN-322	CL-7	XNS-36	NL-34L	\$185.00
MH24 MDUNR/L3-CFT	1.500	1.625	1.125	2.000		IDSN-322	CL-7	XNS-36	NL-34L	\$196.00
MH28 MDUNR/L3-CFT	1.750	1.625	1.250	2.250		IDSN-322	CL-7	XNS-36	NL-34L	\$202.00
MH32 MDUNR/L3-CFT	2.000	1.625	1.375	2.500		IDSN-322	CL-7	XNS-36	NL-34L	\$229.00
MH40 MDUNR/L3-CFT	2.500	1.625	1.500	2.950		IDSN-322	CL-7	XNS-36	NL-34L	\$262.25
MH20 MDUNR/L4-CFT	1.250	1.625	1.000	1.705	DNMG 432	IDSN-433	CL-20	XNS-48	NL-46	\$185.00
MH24 MDUNR/L4-CFT	1.500	1.625	1.125	2.000		IDSN-433	CL-22	XNS-48	NL-46	\$196.00
MH28 MDUNR/L4-CFT	1.750	1.625	1.250	2.250		IDSN-433	CL-22	XNS-48	NL-46	\$202.00
MH32 MDUNR/L4-CFT	2.000	1.625	1.375	2.500		IDSN-433	CL-22	XNS-48	NL-46	\$229.00
MH40 MDUNR/L4-CFT	2.500	1.625	1.500	2.950		IDSN-433	CL-22	XNS-48	NL-46	\$247.00

Also available in: [Steel pg: 39](#) [Modular pg: 80](#)

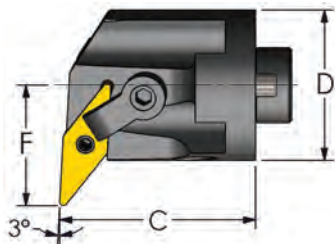

**Negative 35° Diamond
(-3° Lead)
Coolant Thru**

Designation Right Hand	D Dia.	C OAL	F	Min Bore	Insert	Shim	Clamp	Clamp Screw	Lock Pin	Price
MH16 MVUNR/L3-CFT	1.000	1.625	.875	1.435	VNMG 332	IVSN-322	CL-20	XNS-47	NL-34L	\$180.00
MH20 MVUNR/L3-CFT	1.250	1.625	1.000	1.705		IVSN-322	CL-20	XNS-47	NL-34L	\$185.00
MH24 MVUNR/L3-CFT	1.500	1.625	1.125	2.000		IVSN-322	CL-20	XNS-47	NL-34L	\$196.00
MH28 MVUNR/L3-CFT	1.750	1.625	1.250	2.250		IVSN-322	CL-20	XNS-47	NL-34L	\$202.00
MH32 MVUNR/L3-CFT	2.000	1.625	1.375	2.500		IVSN-322	CL-20	XNS-47	NL-34L	\$229.00
MH40 MVUNR/L3-CFT	2.500	1.625	1.750	3.250		IVSN-322	CL-20	XNS-47	NL-34L	\$247.00
MH40 MVUNR/L4-CFT	2.500	1.625	1.750	3.250	VNMG 432	IVSN-432	CL-22	XNS-48	NL-46	\$247.00

Also available in: [Steel pg: 40](#) [Carbide pg: 62](#) [Modular pg: 81](#)

B
BORING

STANDARD Chatter-Free Heads (Negative)

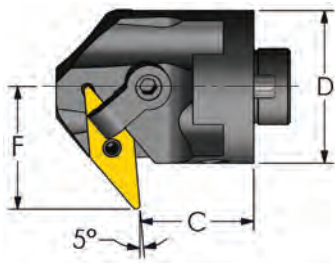

**Negative 35° Diamond
(5° Lead) Back Facing
Coolant Thru**

Designation Right Hand	D Dia.	C OAL	F	Min Bore	Insert	Shim	Clamp	Clamp Screw	Lock Pin	Price
MH16 MVXNR/L3-CFT	1.000	.940	.875	1.435	VNMG 332	IVSN-322	CL-20	XNS-47	NL-34L	\$180.00
MH20 MVXNR/L3-CFT	1.250	1.000	1.000	1.705		IVSN-322	CL-20	XNS-47	NL-34L	\$185.00
MH24 MVXNR/L3-CFT	1.500	1.120	1.125	2.000		IVSN-322	CL-20	XNS-47	NL-34L	\$196.00
MH28 MVXNR/L3-CFT	1.750	1.120	1.250	2.250		IVSN-322	CL-20	XNS-47	NL-34L	\$202.00
MH32 MVXNR/L3-CFT	2.000	1.120	1.375	2.500		IVSN-322	CL-20	XNS-47	NL-34L	\$229.00
MH40 MVXNR/L3-CFT	2.500	1.120	1.750	3.250		IVSN-322	CL-20	XNS-47	NL-34L	\$247.00

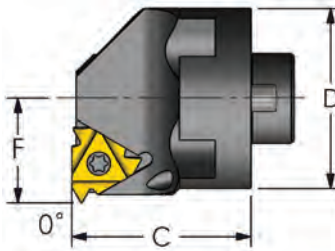

**Threading / Grooving
Laydown
Coolant Thru**

Designation Right Hand	D Dia.	C OAL	F	Min Bore	Insert	Insert Screw	Anvil Screw	Anvil	Price
MH16 LSER3-CFT	1.000	1.625	.650	1.200	3IR	SA3T	SY3T	Y13	\$191.00
MH20 LSER3-CFT	1.250	1.625	.770	1.450		SA3T	SY3T	Y13	\$196.00
MH24 LSER3-CFT	1.500	1.625	.900	1.650		SA3T	SY3T	Y13	\$206.00
MH28 LSER3-CFT	1.750	1.625	1.090	2.020		SA3T	SY3T	Y13	\$222.00
MH32 LSER3-CFT	2.000	1.625	1.281	2.400		SA3T	SY3T	Y13	\$246.00
MH24 LSER4-CFT	1.500	1.625	.978	1.782	4IR	SA4T	SY4T	Y14	\$206.00
MH28 LSER4-CFT	1.750	1.625	1.090	2.020		SA4T	SY4T	Y14	\$222.00
MH32 LSER4-CFT	2.000	1.625	1.281	2.400		SA4T	SY4T	Y14	\$246.00
MH32 LSER5-CFT	2.000	1.625	1.281	2.400	5IR	SA5T	SY5T	Y15	\$246.00
MH40 LSER5-CFT	2.500	1.625	1.530	2.800		SA5T	SY5T	Y15	\$268.00

Designation Left Hand	D Dia.	C OAL	F	Min Bore	Insert	Insert Screw	Anvil Screw	Anvil	Price
MH16 LSEL3-CFT	1.000	1.625	.650	1.200	3IL	SA3T	SY3T	YE3	\$191.00
MH20 LSEL3-CFT	1.250	1.625	.770	1.450		SA3T	SY3T	YE3	\$196.00
MH24 LSEL3-CFT	1.500	1.625	.900	1.650		SA3T	SY3T	YE3	\$206.00
MH28 LSEL3-CFT	1.750	1.625	1.090	2.020		SA3T	SY3T	YE3	\$222.00
MH32 LSEL3-CFT	2.000	1.625	1.281	2.400		SA3T	SY3T	YE3	\$268.00
MH24 LSEL4-CFT	1.500	1.625	.978	1.782	4IL	SA4T	SY4T	YE4	\$206.00
MH28 LSEL4-CFT	1.750	1.625	1.090	2.020		SA4T	SY4T	YE4	\$222.00
MH32 LSEL4-CFT	2.000	1.625	1.281	2.400		SA4T	SY4T	YE4	\$246.00
MH32 LSEL5-CFT	2.000	1.625	1.281	2.400	5IL	SA5T	SY5T	YE5	\$246.00
MH40 LSEL5-CFT	2.500	1.625	1.530	2.800		SA5T	SY5T	YE5	\$268.00

Also available in: Steel pg: 41 Carbide pg: 63 Modular pg: 84 Serrated Chatter-Free pg: 106

B

BORING

STANDARD Chatter-Free Heads (Negative)

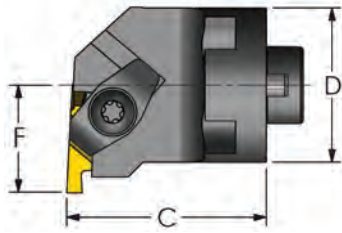

Threading / Grooving
Top Notch
 Coolant Thru

B

BORING

Designation Right Hand	D Dia.	C OAL	F	Min Bore	Insert	Clamp	Screw	Price
MH20 NER3-CFT	1.250	1.625	.875	1.750	NG 3L	CM-73	10-32	\$185.00
MH24 NER3-CFT	1.500	1.625	1.000	2.000		CM-73	10-32	\$195.00
MH28 NER3-CFT	1.750	1.625	1.125	2.250		CM-73	10-32	\$211.00
MH32 NER3-CFT	2.000	1.625	1.250	2.410		CM-73	10-32	\$235.00
MH28 NER4-CFT	1.750	1.625	1.250	2.500	NG 4L	CM-73	10-32	\$211.00
MH32 NER4-CFT	2.000	1.625	1.375	2.750		CM-73	10-32	\$235.00
MH40 NER4-CFT	2.500	1.625	1.625	3.250		CM-73	10-32	\$251.00
MH28 NER6-CFT	1.750	1.625	1.250	2.500	NG 6L	CM-121	10-32	\$211.00
MH32 NER6-CFT	2.000	1.625	1.375	2.750		CM-121	10-32	\$235.00
MH40 NER6-CFT	2.500	1.625	1.625	3.250		CM-121	10-32	\$251.00

Designation Left Hand	D Dia.	C OAL	F	Min Bore	Insert	Clamp	Screw	Price
MH20 NEL3-CFT	1.250	1.625	.875	1.750	NG 3R	CM-72	10-32	\$185.00
MH24 NEL3-CFT	1.500	1.625	1.000	2.000		CM-72	10-32	\$195.00
MH28 NEL3-CFT	1.750	1.625	1.125	2.250		CM-72	10-32	\$211.00
MH32 NEL3-CFT	2.000	1.625	1.250	2.410		CM-72	10-32	\$235.00
MH28 NEL4-CFT	1.750	1.625	1.250	2.500	NG 4R	CM-72	10-32	\$211.00
MH32 NEL4-CFT	2.000	1.625	1.375	2.750		CM-72	10-32	\$235.00
MH40 NEL4-CFT	2.500	1.625	1.625	3.250		CM-72	10-32	\$251.00
MH28 NEL6-CFT	1.750	1.625	1.250	2.500	NG 6R	CM-120	10-32	\$211.00
MH32 NEL6-CFT	2.000	1.625	1.375	2.750		CM-120	10-32	\$235.00
MH40 NEL6-CFT	2.500	1.625	1.625	3.250		CM-120	10-32	\$251.00

Also available in: Steel pg: 41 Carbide pg: 63 Modular pg: 84 Serrated Chatter-Free pg: 106

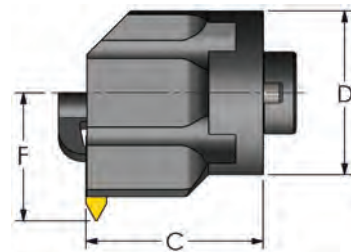

Threading / Grooving
On Edge
 Coolant Thru

Designation Right Hand	D Dia.	C OAL	F	Min Bore	Insert	Clamp	Screw	Lock Pin	Price
MH24 MTHOR/L4-CFT	1.500	1.625	1.173	2.625	TNMA 43	CL-7	XNS-36	NL-44	\$195.00
MH28 MTHOR/L4-CFT	1.750	1.625	1.298	2.750		CL-7	XNS-36	NL-44	\$211.00
MH32 MTHOR/L4-CFT	2.000	1.625	1.423	2.875		CL-7	XNS-36	NL-44	\$235.00

SERRATED “CFT Style” Boring Bars

In addition to our Chatter-Free bars, we offer a solid carbide or steel alternative with the same connection! These solid bars fit all heads following this page with the beginning “SH” designation.

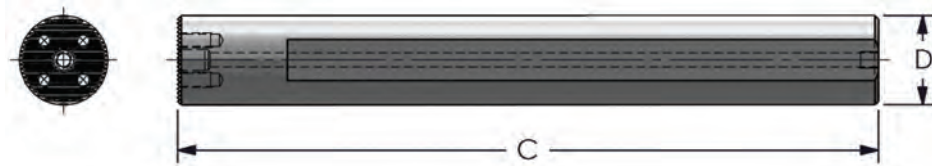

4:1 Ratio

Steel Shank

Coolant Thru

Designation	D Dia.	d1 (Coupling) mm	C OAL	Min Bore	Head Bolts	Price
AS1000-12	1.000	25mm	12	1.260	8-32	\$351.00
AS1250-14	1.250	32mm	14	1.575	10-24	\$442.00
AS1500-14	1.500	32mm	14	1.968	10-24	\$540.00
AS1750-16	1.750	40mm	16	2.010	1/4-20	\$599.00
AS2000-20	2.000	40mm	20	2.400	1/4-20	\$790.00
AS2500-12	2.500	40mm	12	2.800	1/4-20	\$904.00
AS2500-24	2.500	40mm	24	2.800	1/4-20	\$1,293.00

8:1 Ratio

Carbide Shank

Coolant Thru

Designation	D Dia.	d1 (Coupling) mm	C OAL	Min Bore	Head Bolts	Price
ES1000-12	1.000	25mm	12	1.260	8-32	\$1,200.00
ES1250-14	1.250	32mm	14	1.575	10-24	\$2,015.00
ES1500-14	1.500	32mm	14	1.968	10-24	\$2,367.00
ES1750-16	1.750	40mm	16	2.010	1/4-20	\$3,473.00
ES2000-20	2.000	40mm	20	2.400	1/4-20	\$5,097.00

B

BORING

ULTRA-DEX



Hardware
pg: 186



Inserts
pg: 167

Proudly Made in Flushing, MI USA

SERRATED Chatter-Free Boring Bars (English)

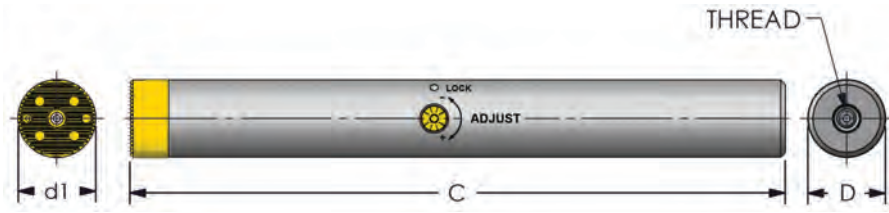

Modular Chatter-Free Bars

Coolant Thru

Designation	D Dia.	d1 (Coupling)	C OAL	Min Bore	Head Bolts	Thread	Price
5:1 Ratio							
SCFT B1500-9	1.500	32mm	9	1.968	10-24 HB	1/8-27 NPT	\$1,158.00
SCFT B2000-12	2.000	40mm	12	2.400	1/4-20 HB	1/8-27 NPT	\$1,407.00
SCFT B2500-16	2.500	40mm	16	2.800	1/4-20 HB	1/8-27 NPT	\$1,914.00
7:1 Ratio							
SCFT B1000-10	1.000	25mm	10	1.260	8-32 HB	1/8-27 NPT	\$889.00
SCFT B1250-12	1.250	32mm	12	1.575	10-24 HB	1/8-27 NPT	\$993.00
SCFT B1500-15	1.500	32mm	15	1.968	10-24 HB	1/8-27 NPT	\$1,158.00
SCFT B1750-18	1.750	40mm	18	2.010	1/4-20 HB	1/8-27 NPT	\$1,328.00
SCFT B2000-20	2.000	40mm	20	2.400	1/4-20 HB	1/8-27 NPT	\$1,407.00
SCFT B2500-27	2.500	40mm	27	2.800	1/4-20 HB	1/4-18 NPT	\$1,914.00
10:1 Ratio							
SCFT B1000-14	1.000	25mm	14	1.260	8-32 HB	1/8-27 NPT	\$1,783.00
SCFT B1250-16	1.250	32mm	16	1.575	10-24 HB	1/8-27 NPT	\$1,993.00
SCFT B1500-19	1.500	32mm	19	1.968	10-24 HB	1/8-27 NPT	\$2,096.00
SCFT B1750-23	1.750	40mm	23	2.010	1/4-20 HB	1/8-27 NPT	\$2,484.00
SCFT B2000-26	2.000	40mm	26	2.400	1/4-20 HB	1/8-27 NPT	\$2,720.00
SCFT B2500-33	2.500	40mm	33	2.800	1/4-20 HB	1/4-18 NPT	\$3,419.00
12:1 Ratio							
SCFT B1000-16	1.000	25mm	16	1.260	8-32 HB	--	\$4,005.00
SCFT B1250-18	1.250	32mm	18	1.575	10-24 HB	--	\$4,960.00
SCFT B1500-22	1.500	32mm	22	1.968	10-24 HB	--	\$6,112.00
SCFT B1750-25	1.750	40mm	25	2.010	1/4-20 HB	--	\$7,472.00
SCFT B2000-29	2.000	40mm	29	2.400	1/4-20 HB	--	\$9,373.00
14:1 Ratio							
SCFT B1000-18	1.000	25mm	18	1.260	8-32 HB	--	\$7,809.00
SCFT B1250-21	1.250	32mm	21	1.575	10-24 HB	--	\$9,305.00
SCFT B1500-25	1.500	32mm	25	1.968	10-24 HB	--	\$10,802.00
SCFT B1750-29	1.750	40mm	29	2.010	1/4-20 HB	--	\$12,568.00
SCFT B2000-33	2.000	40mm	33	2.400	1/4-20 HB	--	\$16,101.00

B

BORING

SERRATED Chatter-Free Boring Bars (Metric)

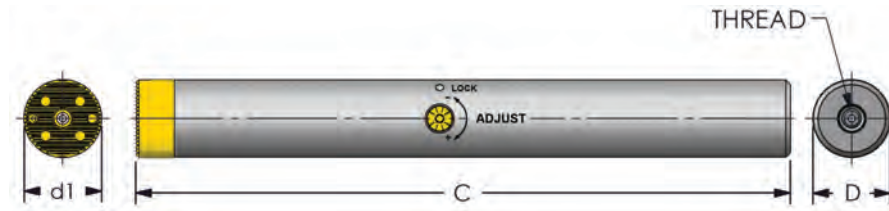

Modular Chatter-Free Bars

Coolant Thru

Designation	D Dia.	d1 (Coupling)	C OAL	Min Bore	Head Bolts	Thread	Price
7:1 Ratio							
SCFT B25MM-250	25mm	25mm	250mm	1.260	8-32 HB	1/8-27 NPT	\$889.00
SCFT B32MM-320	32mm	32mm	320mm	1.575	10-24 HB	1/8-27 NPT	\$993.00
SCFT B40MM-400	40mm	40mm	400mm	1.968	1/4-20 HB	1/8-27 NPT	\$1,158.00
SCFT B50MM-500	50mm	40mm	500mm	2.400	1/4-20 HB	1/8-27 NPT	\$1,407.00
SCFT B60MM-600	60mm	40mm	600mm	2.830	1/4-20 HB	1/8-27 NPT	\$1,914.00
10:1 Ratio							
SCFT B25MM-325	25mm	25mm	325mm	1.260	8-32 HB	1/8-27 NPT	\$1,783.00
SCFT B32MM-416	32mm	32mm	416mm	1.575	10-24 HB	1/8-27 NPT	\$1,993.00
SCFT B40MM-520	40mm	40mm	520mm	1.968	1/4-20 HB	1/8-27 NPT	\$2,096.00
SCFT B50MM-650	50mm	40mm	650mm	2.400	1/4-20 HB	1/8-27 NPT	\$2,720.00
SCFT B60MM-780	60mm	40mm	780mm	2.830	1/4-20 HB	1/8-27 NPT	\$3,419.00
12:1 Ratio							
SCFT B32MM-480	32mm	32mm	480mm	1.575	10-24 HB	--	\$4,960.00
SCFT B40MM-600	40mm	40mm	600mm	1.968	1/4-20 HB	--	\$6,112.00
SCFT B50MM-750	50mm	40mm	750mm	2.400	1/4-20 HB	--	\$9,373.00
14:1 Ratio							
SCFT B32MM-544	32mm	32mm	544mm	1.575	10-24 HB	--	\$9,305.00
SCFT B40MM-680	40mm	40mm	680mm	1.968	1/4-20 HB	--	\$10,802.00
SCFT B50MM-850	50mm	40mm	850mm	2.400	1/4-20 HB	--	\$16,101.00

B

BORING



Hardware
pg: 186



Inserts
pg: 167



SERRATED Chatter-Free Heads (Positive)

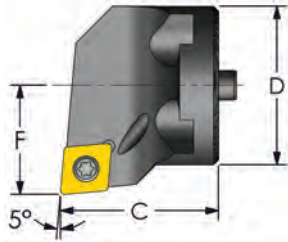

**Positive 80° Diamond
(-5° Lead)
Coolant Thru**

Designation Right Hand	D Dia.	Coupling Size	C OAL	F	Min Bore	Insert	Insert Screw	Key	Price
SH16 SCLCR/L3	.984	25mm	.787	.669	1.260	CCMT 32.52	MTS-35	T-15	\$212.00
SH20 SCLCR/L3	1.260	32mm	1.260	.866	1.575		MTS-35	T-15	\$217.00
SH24 SCLCR/L4	1.575	40mm	1.496	1.063	1.968	CCMT 432	MTS-4	T-20	\$232.00

Steel pg: 25 Carbide pg: 49,50 Heavy Metal pg: 68 Modular pg: 74 Standard Chatter Free pg: 92

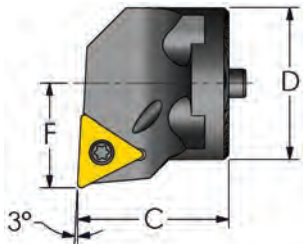

**Positive Triangle
(-3° Lead)
Coolant Thru**

Designation Right Hand	D Dia.	Coupling Size	C OAL	F	Min Bore	Insert	Insert Screw	Key	Price
SH16 STUCR/L2	.984	25mm	.787	.669	1.260	TCMT 21.51	MTS-255	T-7	\$212.00
SH20 STUCR/L3	1.260	32mm	1.260	.866	1.575	TCMT 32.52	MTS-35	T-15	\$217.00
SH24 STUCR/L3	1.575	40mm	1.496	1.063	1.968		MTS-35	T-15	\$232.00

Steel pg: 30 Carbide pg: 55 Heavy Metal pg: 70 Modular pg: 75 Standard Chatter-Free pg: 92

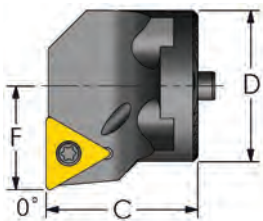

**Positive Triangle
(0° Lead)
Coolant Thru**

Designation Right Hand	D Dia.	Coupling Size	C OAL	F	Min Bore	Insert	Insert Screw	Key	Price
SH16 STFCR/L2	.984	25mm	.787	.669	1.260	TCMT 21.51	MTS-255	T-7	\$212.00
SH20 STFCR/L3	1.260	32mm	1.260	.866	1.575	TCMT 32.52	MTS-35	T-15	\$217.00
SH24 STFCR/L3	1.575	40mm	1.496	1.063	1.968		MTS-35	T-15	\$232.00

Also available in: Steel pg: 32 Carbide pg: 57 Standard Chatter-Free Pg: 93

B

BORING



SERRATED Chatter-Free Heads (Positive)

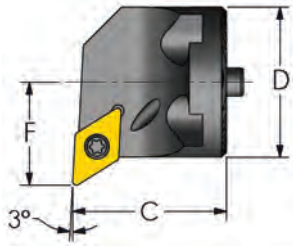

Positive 55° Diamond (-3° Lead) Profiling
Coolant Thru

Designation Right Hand	D Dia.	Coupling Size	C OAL	F	Min Bore	Insert	Insert Screw	Key	Price
SH16 SDUCR/L3	.984	25mm	.787	.669	1.260	DCMT 32.52	MTS-35	T-15	\$212.00
SH20 SDUCR/L3	1.260	32mm	1.260	.866	1.575		MTS-35	T-15	\$217.00
SH24 SDUCR/L3	1.575	40mm	1.260	1.063	1.968		MTS-35	T-15	\$232.00

Also available in: Steel pg: 33 Carbide pg: 59 Modular pg: 76 Standard Chatter-Free pg: 93

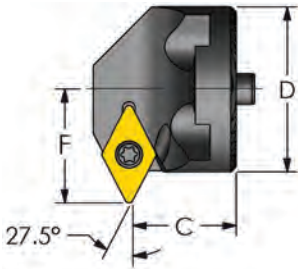

Positive 55° Diamond (27.5° Lead) Profiling
Coolant Thru

Designation Right Hand	D Dia.	Coupling Size	C OAL	F	Min Bore	Insert	Insert Screw	Key	Price
SH16 SDNCR/L2	.984	25mm	.591	.709	1.299	DCMT 21.51	MTS-255	T-7	\$212.00
SH20 SDNCR/L3	1.260	32mm	.787	.866	1.575	DCMT 32.52	MTS-35	T-15	\$217.00
SH24 SDNCR/L3	1.575	40mm	.787	1.063	1.968		MTS-35	T-15	\$232.00

Also available in: Carbide pg: 59 Modular pg: 76

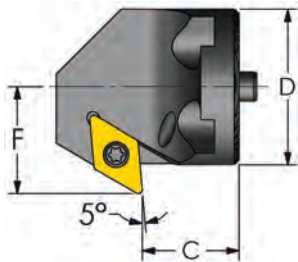

Positive 55° Diamond (5° Lead) Back Facing
Coolant Thru

Designation Right Hand	D Dia.	Coupling Size	C OAL	F	Min Bore	Insert	Insert Screw	Key	Price
SH16 SDXCR/L2	.984	25mm	.591	.709	1.299	DCMT 21.51	MTS-255	T-7	\$212.00
SH20 SDXCR/L3	1.260	32mm	.787	.866	1.575	DCMT 32.52	MTS-35	T-15	\$217.00
SH24 SDXCR/L3	1.575	40mm	.787	1.063	1.968		MTS-35	T-15	\$232.00

Also available in: Steel pg: 35 Carbide pg: 60 Modular pg: 77



Hardware
pg: 186



Inserts
pg: 167

PULLBACK Serrated Chatter-Free Heads

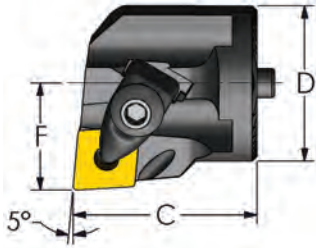

PULLBACK Clamp
Negative 80° Diamond
 (-5° Lead)
Coolant Thru

Designation Right Hand	D Dia.	Coupling Size	C OAL	F	Min Bore	Insert	Shim Seat	Shim Screw	Clamp Assy.	Price
SH20 DCLNR/L4	1.260	32mm	1.496	.866	1.575	CNMG 432	ICSN-433	PB4-SS	PB4-CA	\$268.00
SH24 DCLNR/L4	1.575	40mm	1.496	1.063	1.968		ICSN-433	PB4-SS	PB4-CA	\$279.00

Also available in: [Steel pg: 37](#) [Carbide pg: 61](#) [Modular pg: 82](#)

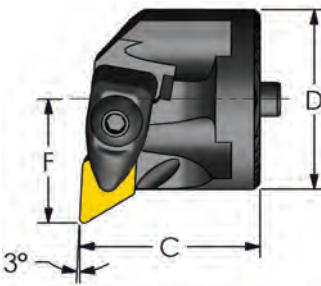

PULLBACK Clamp
Negative 55° Diamond
 (-3° Lead)
Coolant Thru

Designation Right Hand	D Dia.	Coupling Size	C OAL	F	Min Bore	Insert	Shim Seat	Shim Screw	Clamp Assy.	Price
SH20 DDUNR/L3	1.260	32mm	1.260	.866	1.575	DNMG 332	IDSN-322	PB3-SS	PB3-CA	\$268.00
SH24 DDUNR/L4	1.575	40mm	1.260	1.063	1.968	DNMG 432	IDSN-433	PB4-SS	PB4-CA	\$279.00

Also available in: [Steel pg: 39](#) [Carbide pg: 62](#) [Modular pg: 82](#)

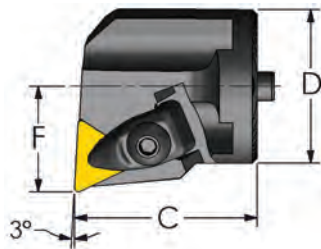

PULLBACK Clamp
Negative Triangle
 (-3° Lead)
Coolant Thru

Designation Right Hand	D Dia.	Coupling Size	C OAL	F	Min Bore	Insert	Shim Seat	Shim Screw	Clamp Assy.	Price
SH20 DTUNR/L3	1.260	32mm	1.496	.866	1.575	TNMG 332	ITSN-323	PB3-SS	PB3-CA	\$268.00
SH24 DTUNR/L3	1.575	40mm	1.496	1.063	1.968		ITSN-323	PB3-SS	PB3-CA	\$279.00

Also available in: [Steel pg: 38](#) [Modular pg: 82](#)

B

BORING

PULLBACK Serrated Chatter-Free Heads

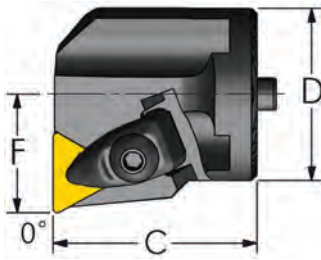

PULLBACK Clamp
Negative Triangle
 (0° Lead)
Coolant Thru

Designation Right Hand	D Dia.	Coupling Size	C OAL	F	Min Bore	Insert	Shim Seat	Shim Screw	Clamp Assy.	Price
SH20 DTFNR/L3	1.260	32mm	1.496	.866	1.575	TNMG 332	ITSN-323	PB3-SS	PB3-CA	\$268.00
SH24 DTFNR/L3	1.575	40mm	1.496	1.063	1.968		ITSN-323	PB3-SS	PB3-CA	\$279.00

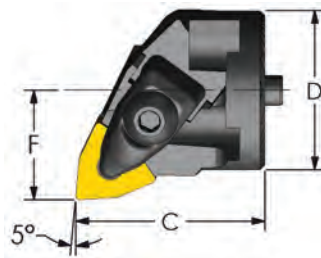

PULLBACK Clamp
Negative Trigon
 (-5° Lead)
Coolant Thru

Designation Right Hand	D Dia.	Coupling Size	C OAL	F	Min Bore	Insert	Shim Seat	Shim Screw	Clamp Assy.	Price
SH20 DWLNR/L4	1.260	32mm	1.496	.866	1.575	WNMG 432	IWSN-433	PB4-SS	PB4-CA	\$268.00
SH24 DWLNR/L4	1.575	40mm	1.496	1.063	1.968		IWSN-433	PB4-SS	PB4-CA	\$279.00

B

BORING

SAME DAY SHIPPING!

On orders placed before 3:00pm EST

SEE PAGE 190 for more details...



PULLBACKs Also Available In:

STEEL pg 37

CARBIDE pg 61

MODULAR pg 82



Hardware
pg: 186



Inserts
pg: 167



Proudly Made in Flushing, MI USA **105**

SERRATED Chatter-Free Heads (Threading / Grooving)

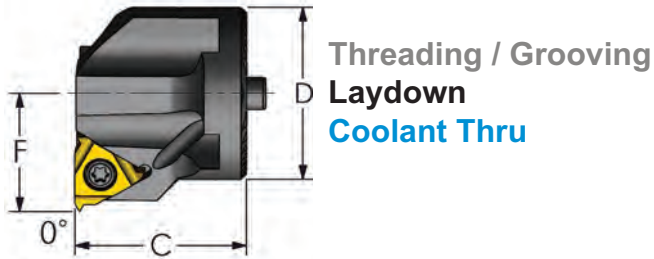

B

BORING

Designation Right Hand	D Dia.	Coupling Size	C OAL	F	Min Bore	Insert	Insert Screw	Anvil Screw	Anvil	Price
SH16 LSER3	.984	25mm	.984	.669	1.260	3IR	SA3T	SY3T	YI3	\$285.00
SH20 LSER3	1.260	32mm	1.260	.866	1.575		SA3T	SY3T	YI3	\$313.00
SH24 LSER3	1.575	40mm	1.496	1.063	1.968		SA3T	SY3T	YI3	\$329.00
SH20 LSER4	1.260	32mm	1.260	.866	1.575	4IR	SA4T	SY4T	YI4	\$313.00
SH24 LSER4	1.575	40mm	1.496	1.063	1.968		SA4T	SY4T	YI4	\$329.00

Designation Left Hand	D Dia.	Coupling Size	C OAL	F	Min Bore	Insert	Insert Screw	Anvil Screw	Anvil	Price
SH16 LSEL3	.984	25mm	.984	.669	1.260	3IL	SA3T	SY3T	YE3	\$285.00
SH20 LSEL3	1.260	32mm	1.260	.866	1.575		SA3T	SY3T	YE3	\$313.00
SH24 LSEL3	1.575	40mm	1.496	1.063	1.968		SA3T	SY3T	YE3	\$329.00
SH20 LSEL4	1.260	32mm	1.260	.866	1.575	4IL	SA4T	SY4T	YE4	\$313.00
SH24 LSEL4	1.575	40mm	1.496	1.063	1.968		SA4T	SY4T	YE4	\$329.00

Also available in: Steel pg: 41 Carbide pg: 63 Modular pg: 83 Standard Chatter-Free pg: 97



Designation Right Hand	D Dia.	Coupling Size	C OAL	F	Min Bore	Insert	Clamp	Screw	Price
SH20 NER3	1.260	32mm	1.340	.866	1.730	NG 3L	CM-73	10-32	\$302.00
SH24 NER3	1.575	40mm	1.575	1.102	2.210		CM-73	10-32	\$317.00
SH24 NER4	1.575	40mm	1.575	1.102	2.210		NG 4L	CM-73	10-32

Designation Left Hand	D Dia.	Coupling Size	C OAL	F	Min Bore	Insert	Clamp	Screw	Price
SH20 NEL3	1.260	32mm	1.340	.866	1.730	NG 3R	CM-72	10-32	\$302.00
SH24 NEL3	1.575	40mm	1.575	1.102	2.210		CM-72	10-32	\$317.00
SH24 NEL4	1.575	40mm	1.575	1.102	2.210		NG 4R	CM-72	10-32

Also available in: Steel pg: 41 Carbide pg: 63 Modular pg: 84 Standard Chatter-Free pg: 98

High Performance Indexable Mills



High-Performance Indexable Mills



- 45° Cutter for face/slot milling and chamfering
- Double sided square insert provides 8 indexes

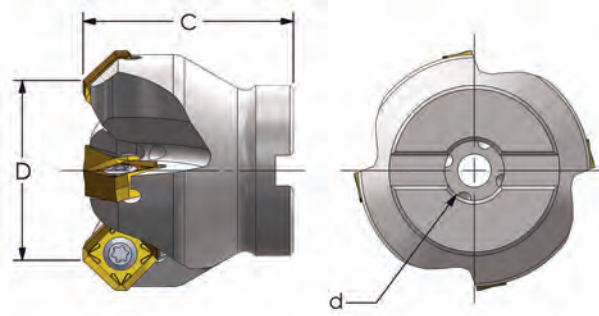

C

MILLING

Face Mill Cutter

Coolant Thru

Designation	D	Flutes	C	d	Insert	Screw	Price
PM1-1.25-3-.500-12	1.250	3	1.750	.500	PM1 1205	PM1-4	\$252.00
PM1-1.50-4-.500-12	1.500	4	1.750	.500			\$294.00
PM1-2.00-5-.750-12	2.000	5	1.750	.750			\$327.00
PM1-2.50-6-1.00-12	2.500	6	2.000	1.000			\$389.00
PM1-3.00-8-1.00-12	3.000	8	2.000	1.000			\$502.00
PM1-4.00-10-1.25-12	4.000	10	2.000	1.250			\$613.00

See page 110 for Speeds and Feeds Chart



Hardware
pg: 186



Inserts
pg: 167

High Performance Indexable Mills



- 90° Cutter for face, slot and shoulder milling
- Single sided insert provides 4 indexes

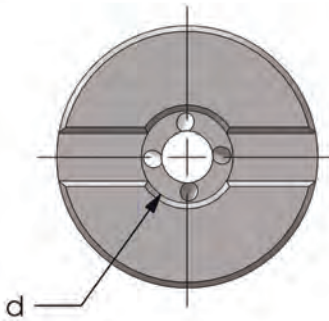
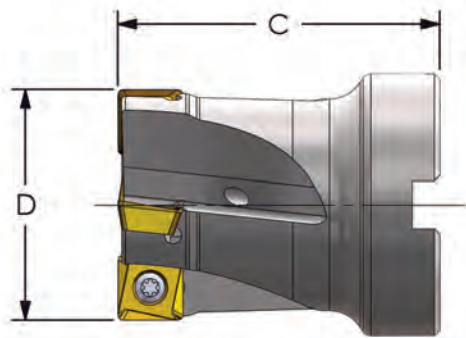

C

MILLING

Face Mill Cutter

Coolant Thru

Designation	D	Flutes	C	d	Insert	Screw	Price
PM2-1.25-4-.500-09	1.250	4	1.750	.500			\$259.00
PM2-1.50-5-.500-09	1.500	5	1.750	.500			\$292.00
PM2-2.00-6-.750-09	2.000	6	1.750	.750	PM2 09T308	PM2-3	\$348.00
PM2-2.50-7-1.00-09	2.500	7	2.000	1.000			\$396.00
PM2-3.00-9-1.00-09	3.000	9	2.000	1.000			\$495.00
PM2-1.50-4-.500-12	1.500	4	1.750	.500			PM2 120508
PM2-2.00-5-.750-12	2.000	5	1.750	.750	\$348.00		
PM2-2.50-6-1.00-12	2.500	6	2.000	1.000	\$396.00		
PM2-3.00-7-1.00-12	3.000	7	2.000	1.000	\$495.00		

New
Insert size

See page 110 for Speeds and Feeds Chart

High Performance Indexable Mills



- High feed cutter for face, slot, plunge milling and angled ramping
- Single sided insert provides 4 indexes

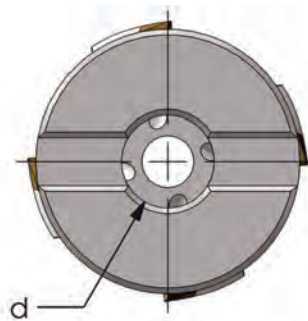
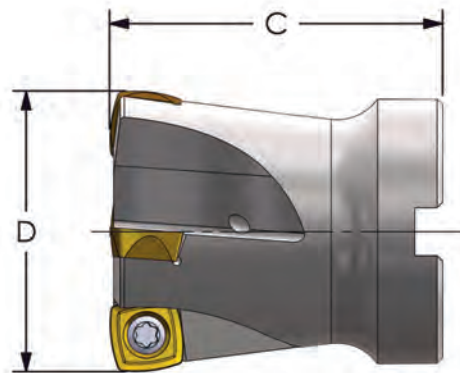

C

MILLING

Face Mill Cutter

Coolant Thru

Designation	D	Flutes	C	d	Insert	Screw	Price
PM3-1.50-4-.500-10	1.500	4	1.750	.500	PM3 10T308	PM3-3.5	\$292.00
PM3-2.00-5-.750-10	2.000	5	1.750	.750			\$348.00
PM3-2.50-6-1.00-10	2.500	6	2.000	1.000			\$378.00

See page 110 for Speeds and Feeds Chart



Hardware
pg: 186



Inserts
pg: 167



High Performance Indexable Mills



- 45° Cutter for face/slot milling and chamfering
- Single sided insert provides 6 indexes

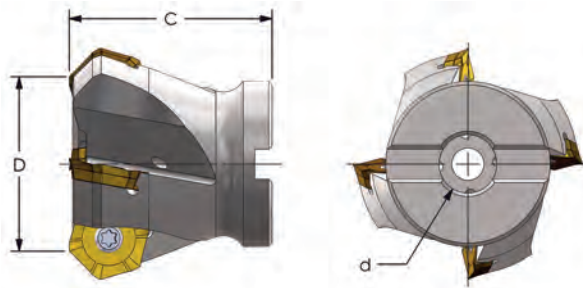

C

MILLING

Face Mill Cutter

Coolant Thru

Designation	D	Flutes	C	d	Insert	Screw	Price
PM4-1.50-4-.500-06	1.500	4	1.750	.500	PM4 0604	PM4-4	\$294.00
PM4-2.00-5-.750-06	2.000	5	1.750	.750			\$327.00
PM4-2.50-6-1.00-06	2.500	6	2.000	1.000			\$389.00
PM4-3.00-7-1.00-06	3.000	7	2.000	1.000			\$492.00
PM4-4.00-9-1.25-06	4.000	9	2.000	1.250			\$592.00

Speeds and Feeds Chart

	Grade	SFM	PM1		PM2		PM3		PM4	
			Inch/ Tooth	Ap (Inch)	Inch/ Tooth	Ap (Inch)	Inch/ Tooth	Ap (Inch)	Inch/ Tooth	Ap (Inch)
Steel	HP470	200-720	.004-.020	.007-.236	.002-.010	.004-.157	.004-.020	.003-.031	.004-.015	.011-.150
Stainless Steel	HM470	200-650	.003-.016	.007-.236	.002-.010	.004-.157	.004-.020	.003-.031	.004-.010	.011-.150
Cast Iron	HK430	350-1050	.003-.017	.007-.236	.002-.010	.004-.157	-	-	.003-.012	.011-.150
Non Ferrous	HN432	<6500	-	-	.002-.011	.004-.157	-	-	.004-.015	.011-.150
Heat Resistant	HS470	80-250	.003-.010	.007-.236	.002-.006	.004-.157	.004-.020	.003-.031	.002-.005	.007-.150
Titanium	HS480	80-250	-	-	.002-.006	.004-.157	.004-.020	.003-.031	-	-



MILLING

INDEXABLE CUTTERS



C

MILLING

Cutting Conditions

APKT 11T308

Feed Per Tooth (inch)

Depth of cut ↑	Feed Per Tooth (inch)			
	AP (inch)	Light	Medium	Heavy
	.315	.0028	.0031	.0039
	.236	.0039	.0047	.0059
.157	.0047	.0059	.0079	

————— f/t —————→

APKT 160408

Feed Per Tooth (inch)

Depth of cut ↑	Feed Per Tooth (inch)			
	AP (inch)	Light	Medium	Heavy
	.472	.0028	.0031	.0039
	.315	.0039	.0047	.0059
.197	.0047	.0059	.0079	

————— f/t —————→



Hardware
pg: 186



Inserts
pg: 167



Indexable End Mill Cutters

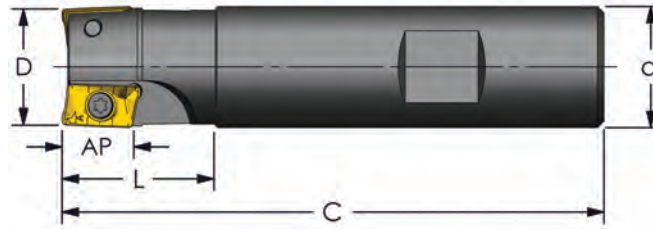

End Mill Cutters

No Coolant

Designation	D	Flutes	C OAL	L	AP	d	Insert	Screw	Price
E90AP D.500-1-W.500-11	.500	1	3.375	.975	.315	.500	APKT 11T308	SR34505	\$107.00
E90AP D.625-2-W.625-11	.625	2	3.375	.975	.315	.625		SR34505	\$107.00
E90AP D.750-2-W.750-11	.750	2	3.375	.975	.315	.750		SR34505L	\$119.00
E90AP D.750-3-W.750-11	.750	3	3.375	.975	.315	.750		SR34505L	\$143.00
E90AP D.750-3-W.750-6-11	.750	3	6.000	3.000	.315	.750		SR34505L	\$179.00
E90AP D1.00-3-W.750-11	1.000	3	4.000	1.500	.315	.750		SR34505L	\$143.00
E90AP D1.00-3-W1.00-11	1.000	3	4.000	1.500	.315	1.000		SR34505L	\$155.00
E90AP D1.00-3-W1.00-6-11	1.000	3	6.000	3.000	.315	1.000		SR34505L	\$191.00
E90AP D1.250-3-W.750-11	1.250	3	4.000	1.500	.315	.750		SR34505L	\$143.00
E90AP D1.250-3-W1.00-11	1.250	3	4.000	1.500	.315	1.000		SR34505L	\$155.00
E90AP D1.500-5-W1.00-11	1.500	5	4.000	1.500	.315	1.000	SR34505L	\$167.00	
E90AP D1.00-2-W1.00-16	1.000	2	4.000	1.750	.472	1.000	APKT 160408	SR14544	\$131.00
E90AP D1.00-2-W1.00-6-16	1.000	2	6.000	4.000	.472	1.000		SR14544	\$167.00
E90AP D1.250-2-W1.00-16	1.250	2	4.000	1.500	.472	1.000		SR14544	\$143.00
E90AP D1.250-3-W1.00-16	1.250	3	4.000	1.500	.472	1.000		SR14544	\$155.00
E90AP D1.500-3-W1.00-16	1.500	3	4.000	1.500	.472	1.000		SR14544	\$155.00

End Mill Cutters

Coolant Thru

Designation	D	Flutes	C OAL	L	AP	d	Insert	Screw	Price
E90AP D.750-2-W.750-11-C	.750	2	3.375	.975	.315	.750	APKT 11T308	SR34505L	\$137.00
E90AP D.750-3-W.750-11-C	.750	3	3.375	.975	.315	.750		SR34505L	\$161.00
E90AP D1.00-3-W1.00-11-C	1.000	3	4.000	1.500	.315	1.000		SR34505L	\$173.00
E90AP D1.250-3-W1.00-16-C	1.250	3	4.000	1.500	.472	1.000	APKT 160408	SR14544	\$179.00
E90AP D1.500-3-W1.00-16-C	1.500	3	4.000	1.500	.472	1.000		SR14544	\$179.00



End Mill Holders Available In:

- CAT40** pg 133
- CAT50** pg 139
- HSK63** pg 148
- HSK100** pg 153

C

MILLING

Indexable End / Face Mill Cutters

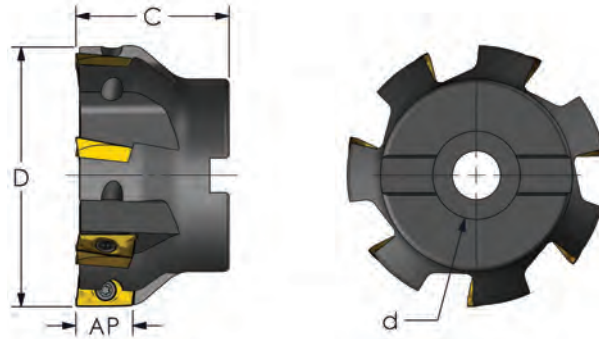

Face Mill Cutters

No Coolant

Designation	D	Flutes	C	AP	d	Inserts	Screw	Price
F90AP D2.00-5-.750-11	2.000	5	1.570	.315	.750	APKT 11T308	SR34505L	\$222.00
F90AP D2.50-7-1.00-11	2.500	7	1.750	.315	1.000		SR34505L	\$299.00
F90AP D3.00-8-1.00-11	3.000	8	1.750	.315	1.000		SR34505L	\$372.00
F90AP D2.00-5-.750-16	2.000	5	1.570	.472	.750	APKT 160408	SR14544	\$216.00
F90AP D2.50-5-1.00-16	2.500	5	1.750	.472	1.000		SR14544	\$285.00
F90AP D3.00-5-1.00-16	3.000	5	1.750	.472	1.000		SR14544	\$349.00
F90AP D3.00-7-1.00-16	3.000	7	1.750	.472	1.000		SR14544	\$372.00
F90AP D4.00-7-1.25-16	4.000	7	2.000	.472	1.250		SR14544	\$451.00

C

MILLING

DON'T THROW IT

Send Us Your Damaged Tooling for Repair



See [pg. 188](#)
For More
Details

SAME DAY SHIPPING!

On orders placed before 3:00pm EST
SEE PAGE 190 for more details...

3:00

ULTRA-DEX



Hardware
pg: 186



Inserts
pg: 167

Proudly Made in Flushing, MI USA **113**

ROUND Indexable End / Face Mill Cutters

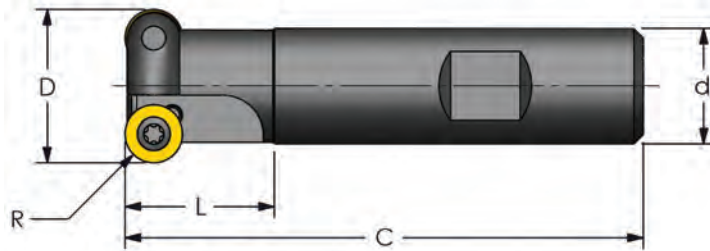

ROUND End Mill Cutters

No Coolant

Designation	D	Flutes	R	C	L	d	Insert	Screw	Price
ER-D.750-2-.750-08	.750	2	.157 / 4mm	3.380	.975	.750	RDKW 0803	MTS 3-DR	\$143.00
ER-D1.00-2-.750-08	1.000	2		3.380	1.500	.750		MTS 3-DR	\$155.00
ER-D1.00-2-.750-10	1.000	2	.197 / 5mm	3.380	1.500	.750	RCKT 10T3	MTS-35	\$155.00
ER-D1.25-3-1.00-10	1.250	3		4.000	1.500	1.000		MTS-35	\$167.00
ER-D1.50-3-1.00-12	1.500	3	.236 / 6mm	4.000	1.500	1.000	RCKT 1204	MTS-35	\$191.00
Designation	D	Flutes	R	C	L	d	Insert	Screw	Price
ER-D.750-2-.750-2	.750	2	.125	3.380	.975	.750	RCMT 21.5	MTS-2.5L	\$143.00
ER-D1.00-2-.750-2	1.000	2		3.380	1.500	.750		MTS-2.5L	\$155.00
ER-D1.00-2-.750-3	1.000	2	.188	3.380	1.500	.750	RCMT 32.5	MTS 4-DR	\$155.00
ER-D1.25-2-1.00-3	1.250	2		4.000	1.500	1.000		MTS 4-DR	\$167.00
ER-D1.50-3-1.00-4	1.500	3	.250	4.000	1.500	1.000	RCMT 43	MTS-4	\$191.00

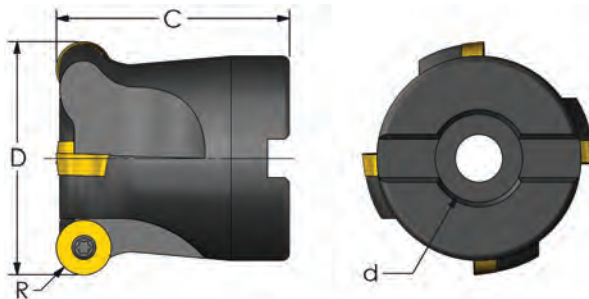

ROUND Face Mill Cutters

No Coolant

Designation	D	Flutes	R	C	d	Insert	Screw	Price
FR-D2.00-4-.750-12	2.000	4	.236 / 6mm	2.000	.750	RCKT 1204	MTS-35	\$251.00
FR-D2.00-3-.750-16	2.000	3	.315 / 8mm	2.000	.750	RCKT 1606	MTS-4	\$227.00
FR-D3.00-5-1.00-16	3.000	5		1.750	1.000		MTS-4	\$287.00
FR-D4.00-6-1.25-16	4.000	6		1.750	1.250		MTS-4	\$331.00
Designation	D	Flutes	R	C	d	Insert	Screw	Price
FR-D2.00-4-.750-4	2.000	4	.250	2.000	.750	RCMT 43	MTS-4	\$251.00
FR-D3.00-5-1.00-4	3.000	5	.250	1.750	1.000		MTS-4	\$287.00
FR-D4.00-6-1.25-4	4.000	6	.250	1.750	1.250		MTS-4	\$331.00

C

MILLING

High Performance Indexable Counterbores



High-Performance Indexable Counterbores

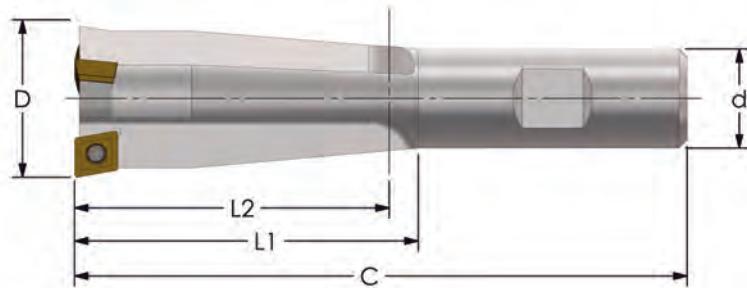

- Designed for high production of standard inch and metric size counterbores
- Newly designed insert achieves 90° bottom

PATRIOT Counterbores

Coolant Thru

Designation	C'bore Size	D	L1	L2	C	Insert	Screw	Flutes	d	Price
PC1-312-2-750-04	5/16	.500	1.345	1.000	3.375	PD1 042004	PD1-16	2	.750	\$157.00
PC1-375-2-750-04	3/8	.594	1.470	1.188	3.500	PD1 042004	PD1-16	2	.750	\$165.00
PC1-437-2-750-05	7/16	.687	1.595	1.374	3.625	PD1 052804	PD1-2	2	.750	\$173.00
PC1-500-2-750-06	1/2	.781	1.720	1.562	3.750	PD1 063306	PD1-22	2	.750	\$183.00
PC1-625-3-750-06	5/8	1.000	2.220	2.000	4.250	PD1 063306	PD1-22	3	.750	\$198.00
PC1-750-3-750-07	3/4	1.188	2.595	2.376	4.625	PD1 074006	PD1-25	3	.750	\$214.00
PC1-315-2-750-04	8mm	.591	1.470	1.182	3.500	PD1 042004	PD1-16	2	.750	\$157.00
PC1-394-2-750-05	10mm	.709	1.595	1.418	3.625	PD1 052804	PD1-2	2	.750	\$173.00
PC1-472-2-750-06	12mm	.787	1.720	1.574	3.750	PD1 063306	PD1-22	2	.750	\$183.00
PC1-630-3-750-06	16mm	1.024	2.220	2.048	4.250	PD1 063306	PD1-22	3	.750	\$198.00
PC1-787-3-750-07	20mm	1.299	2.720	2.598	4.750	PD1 074006	PD1-25	3	.750	\$214.00



Hardware
pg: 186



Inserts
pg: 167

Proudly Made in Flushing, MI USA 115

C

MILLING

High Performance Indexable Counterbores

C

MILLING



Figure 1

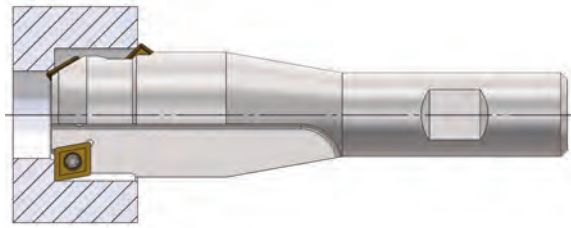
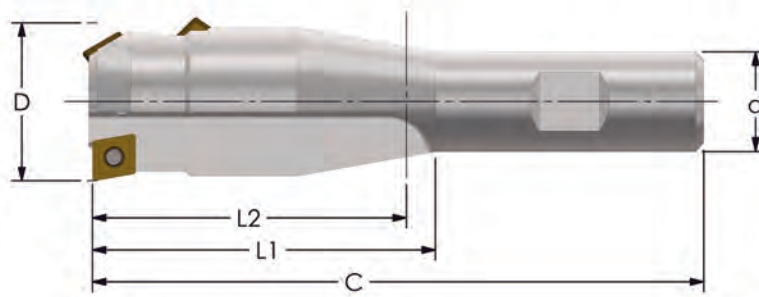
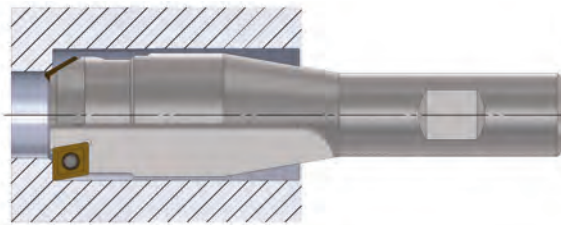

Figure 2



- Single tool to counterbore and dual chamfer in one operation
- Secondary chamfer insert can be removed for deeper application (see figure 2)

PATRIOT Counterbores

Coolant Thru

Designation	C'bore Size	D	L1	L2	C	Insert	Screw	Flutes	d	Price
PC2-312-3-750-04	5/16	.500	1.345	1.000	3.375	PD1 042004	PD1-16	3	.750	\$157.00
PC2-375-3-750-04	3/8	.594	1.470	1.188	3.500	PD1 042004	PD1-16	3	.750	\$165.00
PC2-437-3-750-05	7/16	.687	1.595	1.374	3.625	PD1 052804	PD1-2	3	.750	\$173.00
PC2-500-3-750-06	1/2	.781	1.720	1.562	3.750	PD1 063306	PD1-22	3	.750	\$183.00
PC2-625-3-750-06	5/8	1.000	2.220	2.000	4.250	PD1 063306	PD1-22	3	.750	\$198.00
PC2-750-3-750-07	3/4	1.188	2.595	2.376	4.625	PD1 074006	PD1-25	3	.750	\$214.00
PC2-315-3-750-04	8mm	.591	1.470	1.182	3.500	PD1 042004	PD1-16	3	.750	\$157.00
PC2-394-3-750-05	10mm	.709	1.595	1.418	3.625	PD1 052804	PD1-2	3	.750	\$173.00
PC2-472-3-750-06	12mm	.787	1.720	1.574	3.750	PD1 063306	PD1-22	3	.750	\$183.00
PC2-630-3-750-06	16mm	1.024	2.220	2.048	4.250	PD1 063306	PD1-22	3	.750	\$198.00
PC2-787-3-750-07	20mm	1.299	2.720	2.598	4.750	PD1 074006	PD1-25	3	.750	\$214.00

High Performance Indexable Counterbores

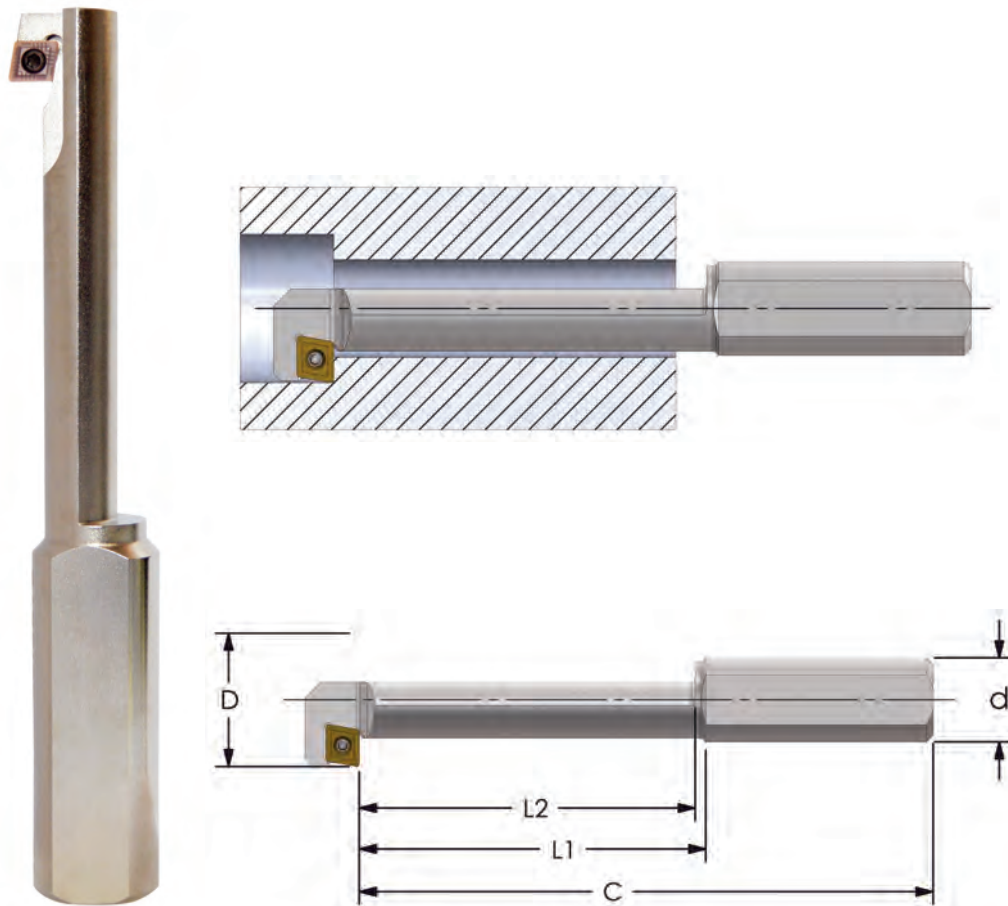

- Back Counterbore tool
- Reduces production time by eliminating a second operation

PATRIOT Counterbores

No Coolant

Designation	C'bore Size	D	L1	L2	C	Insert	Screw	Flutes	d	Price
PC3-312-1-750-04	5/16	.500	1.345	1.030	3.375	PD1 042004	PD1-16	1	.750	\$144.00
PC3-375-1-750-04	3/8	.594	1.470	1.218	3.500	PD1 042004	PD1-16	1	.750	\$152.00
PC3-437-1-750-05	7/16	.687	1.970	1.748	4.000	PD1 052804	PD1-2	1	.750	\$160.00
PC3-500-1-750-06	1/2	.781	2.220	1.983	4.250	PD1 063306	PD1-22	1	.750	\$168.00
PC3-625-1-750-06	5/8	1.000	2.720	2.530	4.750	PD1 063306	PD1-22	1	.750	\$183.00
PC3-750-1-750-07	3/4	1.188	3.095	3.000	5.125	PD1 074006	PD1-25	1	.750	\$198.00
PC3-315-1-750-04	8mm	.591	1.470	1.212	3.500	PD1 042004	PD1-16	1	.750	\$146.00
PC3-394-1-750-05	10mm	.709	1.720	1.448	3.750	PD1 052804	PD1-2	1	.750	\$160.00
PC3-472-1-750-06	12mm	.787	2.220	1.998	4.250	PD1 063306	PD1-22	1	.750	\$168.00
PC3-630-1-750-06	16mm	1.024	2.720	2.590	4.750	PD1 063306	PD1-22	1	.750	\$183.00
PC3-787-1-750-07	20mm	1.299	3.345	3.278	5.375	PD1 074006	PD1-25	1	.750	\$198.00



Hardware
pg: 186



Inserts
pg: 167

Proudly Made in Flushing, MI USA 117

C

MILLING

CHAMFER Indexable Milling Cutters

CHAMFER INDEXABLE MILLING

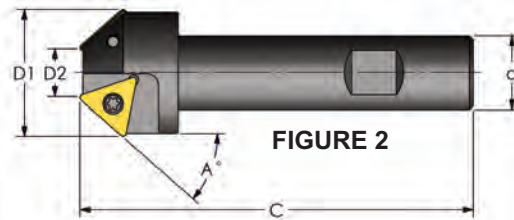
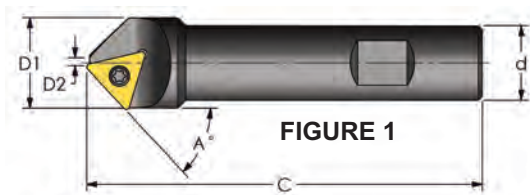

C

MILLING

CHAMFER Mill Cutters

No Coolant

Designation	Figure	A°	D1	D2	C	d	Insert	Screw	Price
E05C-D.500-1-.750-3	1	5	.594	.500	4.000	.750	TCMT 32.52	MTS-35	\$101.00
E10C-D.500-1-.750-3	1	10	.688	.500	4.000	.750		MTS-35	\$101.00
E15C-D.500-1-.750-3	1	15	.782	.500	4.000	.750		MTS-35	\$101.00
E15C-D1.00-2-.750-3	2	15	1.280	1.000	4.000	.750		MTS-35	\$119.00
E20C-D.375-1-.750-3	1	20	.750	.375	4.000	.750		MTS-35	\$101.00
E30C-D.250-1-.750-3	1	30	.800	.250	4.000	.750		MTS-35	\$101.00
E30C-D.750-2-.750-3	2	30	1.300	.750	4.000	.750		MTS-35	\$119.00
E41C-D.188-1-.750-3	1	41	.914	.188	4.000	.750		MTS-35	\$101.00
E41C-D.562-2-.750-3	2	41	1.288	.562	4.000	.750		MTS-35	\$119.00
E45C-D.188-1-.750-3	1	45	.972	.188	4.000	.750		MTS-35	\$101.00
E45C-D.500-2-.750-3	2	45	1.290	.500	4.000	.750		MTS-35	\$119.00
E60C-D.188-2-.750-3	2	60	1.160	.188	4.000	.750		MTS-35	\$119.00

ISO MILLING BARS

Engineered to fit most threaded ISO milling heads

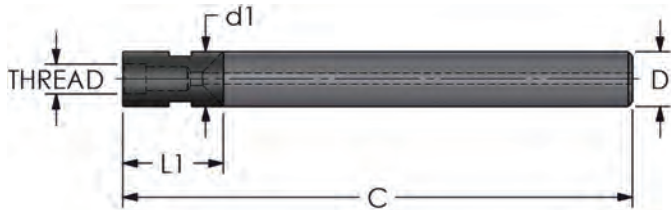

! Optional relief available (d1) CALL FOR PRICING !

Carbide ISO Milling Bar w/ Flat

Coolant Thru

Designation	C	Thread	D	d1	Price
CM06 L6.00-W.375 *	6	M6	.375	--	\$210.00
CM08 L5.00-W.500 *	5	M8	.500	.460	\$236.00
CM08 L8.00-W.500 *	8	M8	.500	.460	\$275.00
CM10 L7.00-W.750	7	M10	.750	.710	\$433.00
CM10 L10.00-W.750	10	M10	.750	.710	\$473.00

Designation	C	Thread	D	d1	Price
CM12 L7.00-W.750	7	M12	.750	.710	\$433.00
CM12 L10.00-W.750	10	M12	.750	.710	\$473.00
CM12 L8.00-W1.00	8	M12	1.000	.960	\$644.00
CM12 L12.00-W1.00	12	M12	1.000	.960	\$815.00
CM16 L14.00-W1.25 *	14	M16	1.250	1.210	\$1,434.00
CM16 L14.00-W1.500 *	14	M16	1.500	1.460	\$1,758.00

Carbide ISO Milling Bar w/o Flat

Coolant Thru

Designation	C	Thread	D	d1	Price
CM08 L8.00-C.500 *	8	M8	.500	.460	\$275.00
CM10 L7.00-C.750	7	M10	.750	.710	\$433.00
CM10 L10.00-C.750	10	M10	.750	.710	\$473.00

Designation	C	Thread	D	d1	Price
CM12 L7.00-C.750	7	M12	.750	.710	\$433.00
CM12 L10.00-C.750	10	M12	.750	.710	\$473.00
CM12 L8.00-C1.00	8	M12	1.000	.960	\$655.00
CM12 L12.00-C1.00	12	M12	1.000	.960	\$815.00
CM16 L14.00-C1.25 *	14	M16	1.250	1.210	\$1,434.00

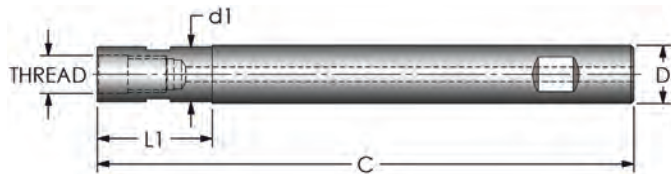

Heavy Metal ISO Milling Bar w/ Flat

Coolant Thru

Designation	C	Thread	D	d1	Price
HM06 L6.00-W.375 *	6	M6	.375	--	\$214.00
HM08 L6.00-W.500 *	6	M8	.500	.460	\$283.00
HM12 L12.00-W.750 *	12	M12	.750	.710	\$511.00
HM12 L8.00-W1.00 *	8	M12	1.000	.960	\$657.00

Designation	C	Thread	D	d1	Price
HM12 L12.00-W1.00 *	12	M12	1.000	.960	\$748.00
HM16 L12.00-W1.25 *	12	M16	1.250	1.210	\$1,164.00
HM16 L12.00-W1.500 *	12	M16	1.500	1.460	\$1,513.00

Heavy Metal ISO Milling Bar w/o Flat

Coolant Thru

Designation	C	Thread	D	d1	Price
HM06 L6.00-C.375 *	6	M6	.375	--	\$214.00
HM08 L6.00-C.500 *	6	M8	.500	.460	\$283.00
HM12 L12.00-C.750 *	12	M12	.750	.710	\$511.00

Designation	C	Thread	D	d1	Price
HM12 L8.00-C1.00 *	8	M12	1.000	.960	\$657.00
HM12 L12.00-C1.00 *	12	M12	1.000	.960	\$748.00
HM16 L12.00-C1.25 *	12	M16	1.250	1.210	\$1,164.00

* Please allow up to 1 week for processing.



Hardware
pg: 186



Inserts
pg: 167

Proudly Made in Flushing, MI USA

ISO Milling Bars (Metric)

Metric ISO Milling Bars

Engineered to fit most threaded ISO milling heads

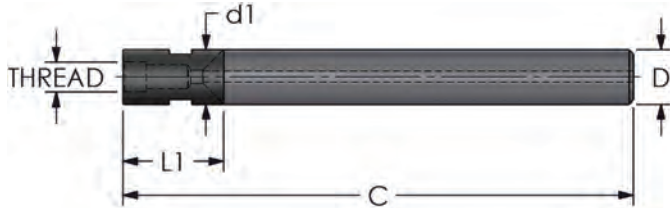

! Optional relief available (d1) CALL FOR PRICING !

Carbide ISO Milling Bar w/o Flat

Coolant Thru

Designation	C (mm)	Thread	D (mm)	d1 (mm)	Price
CM06 L150MM-C10MM	150	M6	10	-	\$222.00
CM06 L180MM-C12MM	180	M6	12	11	\$291.00
CM08 L200MM-C16MM	200	M8	16	14.5	\$374.00
CM10 L250MM-C20MM	250	M10	20	18.5	\$500.00
CM12 L300MM-C25MM	300	M12	25	23.5	\$863.00

C

MILLING

DON'T THROW IT
 Send Us Your Damaged Tooling for Repair

See **pg. 188**
 For More
 Details

SAME DAY SHIPPING!

On orders placed before 3:00pm EST

SEE PAGE 190 for more details...

3:00

PATRIOT High Performance Indexable Drills



High-Performance Indexable Drills

3xD

Now Available in new sizes!

2xD 4xD

BEST Value in the Industry!

- Diameter Range (.562 - 2.125")
- Hardened High Quality tool steel & electroless nickel coated for rigidity, wear resistance & reduced chip wash
- New and Improved 4-edge insert design to provide excellent chip control with lower spindle loads
- Same insert can be used as inboard & outboard insert
+ No risk of mixing up inner & outer
- Engineered flute design optimized for superior chip evacuation & rigidity
- Able to offset and drill into slant workpieces without pre-drilling
- 2-port internal coolant system for high-efficient drilling
- X-offset design to adjust diameter size on turning centers, and optimize tolerances on machining centers



Hardware
pg: 186



Inserts
pg: 167



D

DRILLING

Proudly Made in Flushing, MI USA **121**

High Performance Indexable Drills

New Sizes

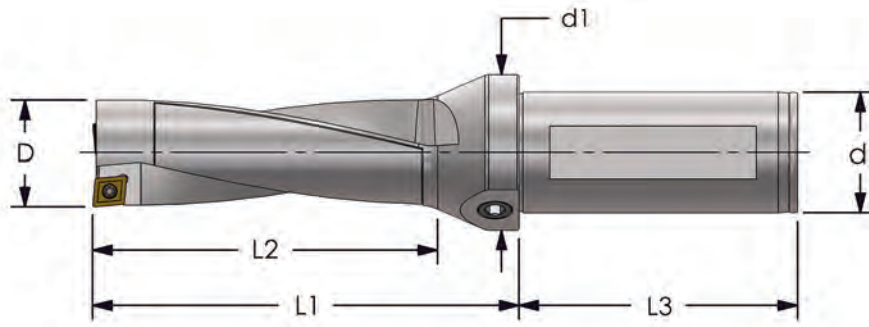

2xD Indexable Drills High Performance

Coolant Thru

Designation	D	d	d1	L3	L1	L2	Insert	Screw	Wrench	Price	
PD1-0562-2D-075	.562				2.042	1.242	PD1 042004	PD1-16		\$236.00	
PD1-0625-2D-075	.625	.750	1.120	1.900	2.168	1.368	PD1 052804	PD1-2	T-6-S	\$236.00	
PD1-0687-2D-075	.687				2.292	1.492				\$236.00	
PD1-0750-2D-100	.750				2.561	1.618				\$268.00	
PD1-0812-2D-100	.812	1.000	1.360	2.400	2.686	1.743	PD1 063306	PD1-22	T-7-S	\$268.00	
PD1-0875-2D-100	.875				2.811	1.868		\$268.00			
PD1-0937-2D-125	.937				2.936	1.993		\$268.00			
PD1-1000-2D-125	1.000		1.614	2.900	3.061	2.118	PD1 074006	PD1-25		\$303.00	
PD1-1125-2D-125	1.125	1.250				3.311	2.368			\$303.00	
PD1-1250-2D-125	1.250					3.600	2.657	PD1 094508	PD1-35	T-15-S	\$342.00
PD1-1375-2D-125	1.375				3.850	2.907	\$342.00				
PD1-1500-2D-150	1.500		1.980	1.500	4.100	3.157				\$392.00	
PD1-1625-2D-150	1.625					4.390	3.447	PD1 125812	PD1-5	T-20-S	\$415.00
PD1-1750-2D-150	1.750					4.600	3.657				\$432.00
PD1-2000-2D-150	2.000		1.940		5.100	4.157	PD1 156812	PD1-6	T-25-S	\$519.00	

4xD Indexable Drills High Performance

Coolant Thru

Designation	D	d	d1	L3	L1	L2	Insert	Screw	Wrench	Price	
PD1-0625-4D-075	.625				3.418	2.618	PD1 052804	PD1-2	T-6-S	\$344.00	
PD1-0687-4D-075	.687	.750	1.120	1.900	3.667	2.867				\$344.00	
PD1-0750-4D-100	.750				4.061	3.118					\$390.00
PD1-0812-4D-100	.812	1.000	1.360	2.400	4.312	3.369	PD1 063306	PD1-22	T-7-S	\$390.00	
PD1-0875-4D-100	.875				4.561	3.618		\$390.00			
PD1-0937-4D-125	.937				4.812	3.869		\$390.00			
PD1-1000-4D-125	1.000		1.614	2.900	5.061	4.118	PD1 074006	PD1-25		\$442.00	
PD1-1125-4D-125	1.125	1.250				5.561	4.618			\$442.00	
PD1-1250-4D-125	1.250					6.100	5.157	PD1 094508	PD1-35	T-15-S	\$499.00
PD1-1375-4D-125	1.375				6.600	5.627	\$499.00				
PD1-1500-4D-150	1.500		1.980	1.500	7.140	6.197				\$571.00	
PD1-1625-4D-150	1.625					7.640	6.697	PD1 125812	PD1-5	T-20-S	\$605.00
PD1-1750-4D-150	1.750					8.140	7.197				\$630.00
PD1-2000-4D-150	2.000		1.940		9.140	8.197	PD1 156812	PD1-6	T-25-S	\$757.00	

Continues on next page

D

DRILLING

High Performance Indexable Drills

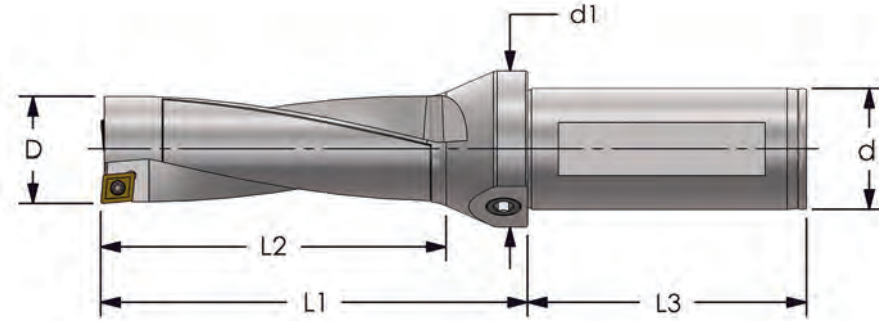

3xD Indexable Drills High Performance

Coolant Thru

Designation	D	d	d1	L3	L1	L2	Insert	Screw	Wrench	Price
PD1-0562-3D-075	.562	.750	1.120	1.900	2.747	1.804	PD1 042004	PD1-16	T-6-S	\$243.00
PD1-0594-3D-075	.594				2.843	1.900				\$243.00
PD1-0609-3D-075	.609				2.888	1.945				\$243.00
PD1-0625-3D-075	.625				2.936	1.993				\$243.00
PD1-0669-3D-075	.669 (17mm)				3.069	2.126				\$243.00
PD1-0687-3D-075	.687				3.122	2.179				\$243.00
PD1-0709-3D-075	.709 (18mm)				3.187	2.244				\$243.00
PD1-0734-3D-100	.734	1.000	1.360	2.400	3.263	2.320	PD1 063306	PD1-22	T-7-S	\$243.00
PD1-0750-3D-100	.750				3.311	2.368				\$276.00
PD1-0787-3D-100	.787 (20mm)				3.422	2.479				\$276.00
PD1-0812-3D-100	.812				3.499	2.556				\$276.00
PD1-0844-3D-100	.844				3.637	2.694				\$276.00
PD1-0875-3D-100	.875				3.686	2.743				\$276.00
PD1-0937-3D-125	.937				3.874	2.931				\$276.00
PD1-0984-3D-125	.984 (25mm)	4.014	3.071	\$276.00						
PD1-1000-3D-125	1.000	1.250	1.614	2.900	4.061	3.118	PD1 074006	PD1-25	T-15-S	\$312.00
PD1-1062-3D-125	1.062				4.249	3.306				\$312.00
PD1-1125-3D-125	1.125				4.436	3.493				\$312.00
PD1-1181-3D-125	1.181 (30mm)	1.500	1.980	2.900	4.645	3.702	PD1 094508	PD1-35	T-20-S	\$312.00
PD1-1250-3D-125	1.250				4.850	3.907				\$353.00
PD1-1312-3D-125	1.312				5.039	4.095				\$353.00
PD1-1375-3D-125	1.375				5.225	4.282				\$353.00
PD1-1437-3D-125	1.437	5.413	4.470	\$353.00						
PD1-1500-3D-150	1.500	1.500	1.980	2.900	5.640	4.697	PD1 125812	PD1-5	T-25-S	\$404.00
PD1-1625-3D-150	1.625				6.015	5.072				\$427.00
PD1-1750-3D-150	1.750				6.390	5.447				\$445.00
PD1-1875-3D-150	1.875				6.825	5.882				\$505.00
PD1-2000-3D-150	2.000				7.140	6.197				\$535.00
PD1-2125-3D-150	2.125				7.515	6.572				\$586.00

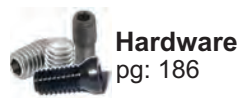
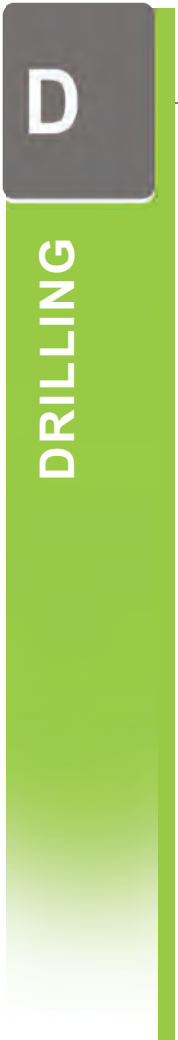



Patriot Drill Speeds and Feeds

SPEEDS AND FEEDS			Ø.562- .734	Ø.750- 1.437	Ø1.500- 2.125
MATERIAL	INSERT GRADE	SFM	INCH/ REV	INCH/ REV	INCH/ REV
STEEL	HP600	400-700	.002-.005	.004-.008	.004-.010
CAST IRON	HK356	350-650	.0025-.005	.004-.008	.004-.010
STAINLESS STEEL	HP600	300-600	.002-.005	.004-.008	.004-.010
ALUMINUM	HK356	800-1400	.003-.008	.004-.010	.005-.012
HEAT RESISTANT STEELS	HP600	90-250	.002-.004	.0025-.006	.0025-.0085

Indexable & Versatile

D

DRILLING

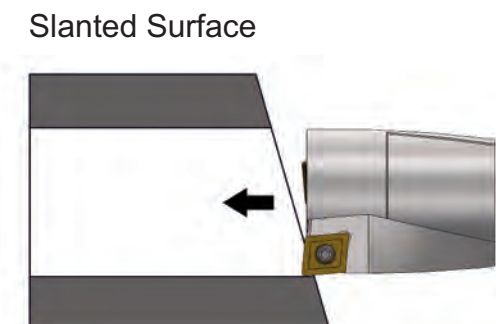
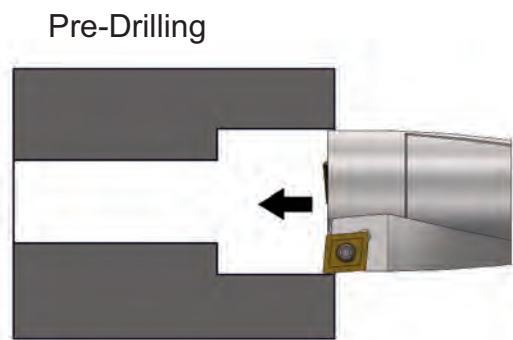
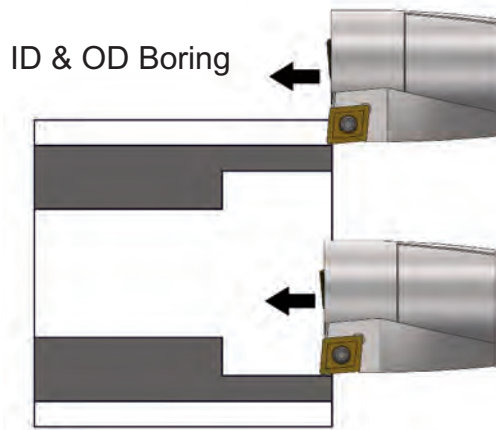
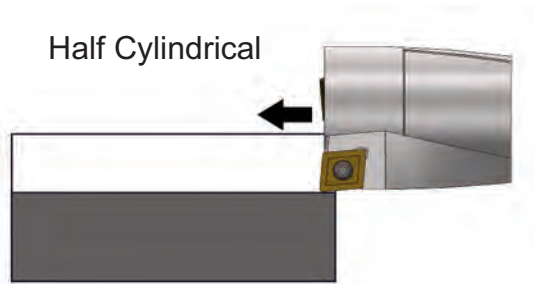

2.5X D Indexable Drills

2xD 2.5xD 4xD INDEXABLE DRILLS

BEST Value in the Industry!

Insert pockets precisely positioned to keep cutting forces low and evenly distributed, 80° Trigon Inserts offer 3 cutting edges!

Spiral flutes to improve chip evacuation.

Coolant-Thru access is located on both the shank and the side of the drill body.

- Drills come with 1/8-27 NTP Port



Work-piece material	SFM	Inch/ Rev
P Steel	225-650	.0022-.006
M Stainless Steel	250-430	.002-.006
K Cast Iron	300-600	.0025-.009
N Ferrite Materials	600-1100	.0038-.011
S Heat-resistant steel	60-150	.0028-.008

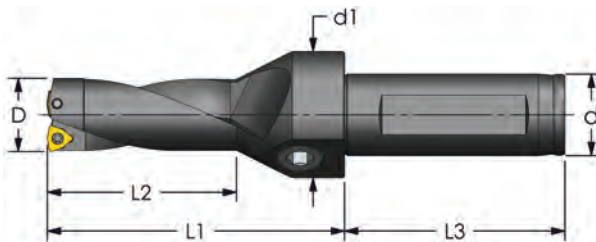

D

DRILLING

2.5xD Indexable Drills (Coated & Uncoated)

Coolant Thru

Designation	D	d	d1	L3	L1	L2	Insert	Screw	Price * Coated	Price
UD-0437-2D-063	.437					1.280	WCMT 1.211	MTS 184	\$153.00	\$138.00
UD-0468-2D-063	.468					1.310		T-6-S Wrench	\$153.00	\$138.00
UD-0500-2D-063	.500	.625	.970	1.687	2.280	1.340	WCMT 1.51.51	MTS 2	\$153.00	\$138.00
UD-0531-2D-063	.531					1.370		T-6-S Wrench	\$153.00	\$138.00
UD-0562-2D-063	.562					1.400	WCMT 1.51.51	T-6-S Wrench	\$153.00	\$138.00
UD-0593-2D-063	.593					1.430		T-6-S Wrench	\$153.00	\$138.00

* Coated with ION Nitride (Add -C to the end of designation)



Hardware
pg: 186



Inserts
pg: 167

2xD Indexable Drills

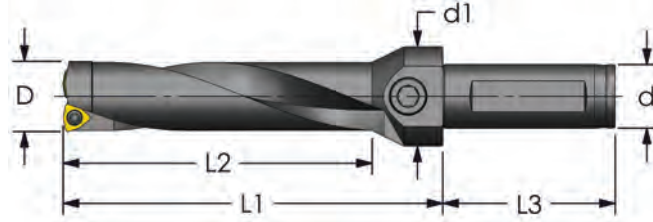

2xD Indexable Drills (Coated & Uncoated)

Coolant Thru

Designation	D	d	d1	L3	L1	L2	Insert	Screw	Price * Coated	Price						
UD-0625-2D-063	.625					1.375	WCMX 1.81.52	MTS-255	\$153.00	\$138.00						
UD-0656-2D-063	.656	.625	.987	1.687	2.280	1.406		T-7-S	\$153.00	\$138.00						
UD-0687-2D-063	.687					1.437		Wrench	\$153.00	\$138.00						
UD-0719-2D-063	.719					1.467			\$153.00	\$138.00						
UD-0750-2D-075	.750									1.748	WCMX 21.52	MTS 25-DR T-8-S Wrench	\$180.00	\$153.00		
UD-0781-2D-075	.781	.750	1.220	2.000	2.810	1.780	\$180.00	\$153.00								
UD-0812-2D-075	.812					1.811	\$180.00	\$153.00								
UD-0844-2D-075	.844					1.850	\$180.00	\$153.00								
UD-0875-2D-075	.875					1.874	\$180.00	\$153.00								
UD-0906-2D-075	.906					1.910	\$180.00	\$153.00								
UD-0937-2D-075	.937					1.935	\$180.00	\$153.00								
UD-0968-2D-075	.968					1.970	\$180.00	\$153.00								
UD-1000-2D-100	1.000									2.345			WCMX 2.522	MTS 3-DR T-9-S Wrench	\$211.00	\$168.00
UD-1031-2D-100	1.031					1.000	1.450	2.375	3.235	2.375					\$211.00	\$168.00
UD-1062-2D-100	1.062									2.406					\$211.00	\$168.00
UD-1094-2D-100	1.094									2.438					\$211.00	\$168.00
UD-1125-2D-100	1.125									2.469	\$211.00	\$168.00				
UD-1156-2D-100	1.156	2.500	\$211.00	\$168.00												
UD-1187-2D-100	1.187	2.532	\$211.00	\$168.00												
UD-1219-2D-100	1.219	2.564	\$211.00	\$168.00												
UD-1250-2D-125	1.250									2.710	WCMX 32.52	MTS 35-DR T-10-S Wrench	\$248.00	\$200.00		
UD-1312-2D-125	1.312	1.250	1.730	2.619	3.886	2.771	\$248.00	\$200.00								
UD-1343-2D-125	1.343					2.802	\$248.00	\$200.00								
UD-1375-2D-125	1.375					2.833	\$248.00	\$200.00								
UD-1437-2D-125	1.437					2.896	\$248.00	\$200.00								
UD-1500-2D-125	1.500					3.250	\$283.00	\$231.00								
UD-1562-2D-125	1.562					1.970	4.426	5.025	3.312	\$283.00			\$231.00			
UD-1625-2D-125	1.625								3.375	\$304.00			\$248.00			
UD-1687-2D-125	1.687								3.437	\$304.00			\$248.00			
UD-1750-2D-150	1.750														3.850	WCMX 433
UD-1812-2D-150	1.812					1.500	2.220	2.875	5.687	3.912	\$324.00	\$263.00				
UD-1875-2D-150	1.875	3.975	\$377.00	\$308.00												
UD-1937-2D-150	1.937	4.036	\$377.00	\$308.00												
UD-2000-2D-150	2.000	4.469	\$407.00	\$340.00												
UD-2125-2D-150	2.125	4.593	\$444.00	\$371.00												
UD-2250-2D-150	2.250	4.717	\$475.00	\$402.00												
UD-2375-2D-150	2.375	4.840	\$505.00	\$433.00												

* Coated with ION Nitride (Add -C to the end of designation)

D

DRILLING

4xD Indexable Drills

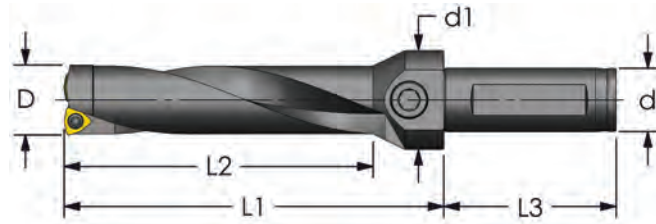

4xD Indexable Drills (Coated & Uncoated)

Coolant Thru

Designation	D	d	d1	L3	L1	L2	Insert	Screw	Price * Coated	Price						
UD-0625-4D-063	.625					2.815	WCMX 1.81.52	MTS-255 T-7-S Wrench	\$220.00	\$199.00						
UD-0656-4D-063	.656	.625	.987	1.687	3.720	2.847			\$220.00	\$199.00						
UD-0687-4D-063	.687					2.878			\$220.00	\$199.00						
UD-0719-4D-063	.719					2.911			\$220.00	\$199.00						
UD-0750-4D-075	.750									3.698	WCMX 21.52	MTS 25-DR T-8-S Wrench	\$258.00	\$220.00		
UD-0781-4D-075	.781					3.729	\$258.00	\$220.00								
UD-0812-4D-075	.812	.750	1.220	2.000	4.763	3.761	\$258.00	\$220.00								
UD-0844-4D-075	.844					3.792	\$258.00	\$220.00								
UD-0875-4D-075	.875					3.824	\$258.00	\$220.00								
UD-0906-4D-075	.906					3.855	\$258.00	\$220.00								
UD-0937-4D-075	.937					3.885	\$258.00	\$220.00								
UD-0968-4D-075	.968					3.918	\$258.00	\$220.00								
UD-1000-4D-100	1.000									4.635			WCMX 2.522	MTS 3-DR T-9-S Wrench	\$302.00	\$243.00
UD-1031-4D-100	1.031									4.666					\$302.00	\$243.00
UD-1062-4D-100	1.062					1.000	1.450	2.375	5.685	4.696	\$302.00	\$243.00				
UD-1094-4D-100	1.094									4.728	\$302.00	\$243.00				
UD-1125-4D-100	1.125	4.760	\$302.00	\$243.00												
UD-1156-4D-100	1.156	4.792	\$302.00	\$243.00												
UD-1187-4D-100	1.187	4.822	\$302.00	\$243.00												
UD-1219-4D-100	1.219	4.864	\$302.00	\$243.00												
UD-1250-4D-125	1.250									5.585	WCMX 32.52	MTS 35-DR T-10-S Wrench			\$353.00	\$287.00
UD-1312-4D-125	1.312									5.646					\$353.00	\$287.00
UD-1375-4D-125	1.375	1.250	1.730	2.619	6.760					5.708			\$353.00	\$287.00		
UD-1437-4D-125	1.437									5.771			\$353.00	\$287.00		
UD-1500-4D-125	1.500					6.632	\$405.00	\$332.00								
UD-1562-4D-125	1.562					1.970	7.800	6.695	\$405.00	\$332.00						
UD-1625-4D-125	1.625							6.757	\$435.00	\$353.00						
UD-1687-4D-125	1.687							6.820	\$435.00	\$353.00						
UD-1750-4D-150	1.750													7.724	WCMX 433	MTS 4-DR T-15-S Wrench
UD-1812-4D-150	1.812									7.786			\$464.00	\$376.00		
UD-1875-4D-150	1.875					1.500	2.220	2.875	8.900	7.849	\$538.00	\$443.00				
UD-1937-4D-150	1.937									7.911	\$538.00	\$443.00				
UD-2000-4D-150	2.000	9.263	\$577.00	\$480.00												
UD-2125-4D-150	2.125	2.470	10.347	9.387	\$635.00					\$531.00						
UD-2250-4D-150	2.250			9.512	\$679.00					\$576.00						
UD-2375-4D-150	2.375			9.637	\$723.00					\$620.00						

* Coated with ION Nitride (Add -C to the end of designation)



Hardware
pg: 186



Inserts
pg: 167



Proudly Made in Flushing, MI USA 127

Drill Offset Chart

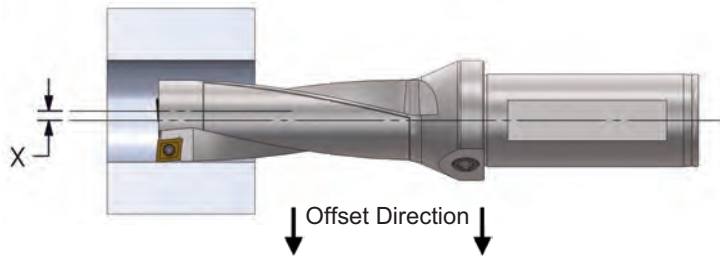

Our Drills offer the ability to offset in turning applications to help with tolerance optimization and creation of holes larger than the drill diameter.

PATRIOT

Designation	Offset (Max)
PD1-0562-3D-075	.007
PD1-0594-3D-075	.005
PD1-0609-3D-075	.005
PD1-0625-3D-075	.015
PD1-0669-3D-075	.011
PD1-0687-3D-075	.009
PD1-0709-3D-075	.007
PD1-0734-3D-100	.019
PD1-0750-3D-100	.017
PD1-0787-3D-100	.011
PD1-0812-3D-100	.009
PD1-0844-3D-100	.005
PD1-0875-3D-100	.004
PD1-0937-3D-125	.023
PD1-0984-3D-125	.019
PD1-1000-3D-125	.017
PD1-1062-3D-125	.009
PD1-1125-3D-125	.004
PD1-1181-3D-125	.035
PD1-1250-3D-125	.027
PD1-1312-3D-125	.021
PD1-1375-3D-125	.013
PD1-1437-3D-125	.008
PD1-1500-3D-150	.039
PD1-1625-3D-150	.027
PD1-1750-3D-150	.015
PD1-1875-3D-150	.051
PD1-2000-3D-150	.039
PD1-2125-3D-150	.023

STANDARD *

Designation	Offset (Max)
UD-0437-2D-063	.018
UD-0468-2D-063	.016
UD-0500-2D-063	.014
UD-0531-2D-063	.023
UD-0562-2D-063	.021
UD-0593-2D-063	.019
UD-0625-2D-063	.023
UD-0656-2D-063	.021
UD-0687-2D-063	.019
UD-0719-2D-063	.017
UD-0750-2D-075	.024
UD-0781-2D-075	.022
UD-0812-2D-075	.021
UD-0844-2D-075	.019
UD-0875-2D-075	.017
UD-0906-2D-075	.015
UD-0937-2D-075	.013
UD-0968-2D-075	.011
UD-1000-2D-100	.029
UD-1031-2D-100	.027
UD-1062-2D-100	.025
UD-1094-2D-100	.023
UD-1125-2D-100	.021
UD-1156-2D-100	.020
UD-1187-2D-100	.018
UD-1219-2D-100	.016
UD-1250-2D-125	.035
UD-1312-2D-125	.031
UD-1343-2D-125	.029
UD-1375-2D-125	.027
UD-1437-2D-125	.023
UD-1500-2D-125	.019
UD-1562-2D-125	.015
UD-1625-2D-125	.011
UD-1687-2D-125	.008
UD-1750-2D-150	.040
UD-1812-2D-150	.036
UD-1875-2D-150	.032
UD-1937-2D-150	.028
UD-2000-2D-150	.024
UD-2125-2D-150	.017
UD-2250-2D-150	.009
UD-2375-2D-150	.001

* 2XD Only

D

DRILLING

Patriot Indexable Drill CUSTOM Order

D

DRILLING

FAX TO 810.638.4001 FOR QUOTE

YOUR INFO:

COMPANY: _____

CONTACT: _____

PHONE: () _____

EXT.: _____

DATE: / /

*PREFERRED DISTRIBUTOR INFO:

COMPANY: _____

CONTACT: _____

PHONE: () _____

EXT.: _____

* If you do not have a preferred distributor, we can provide you with a list of distributors in your area to choose from.

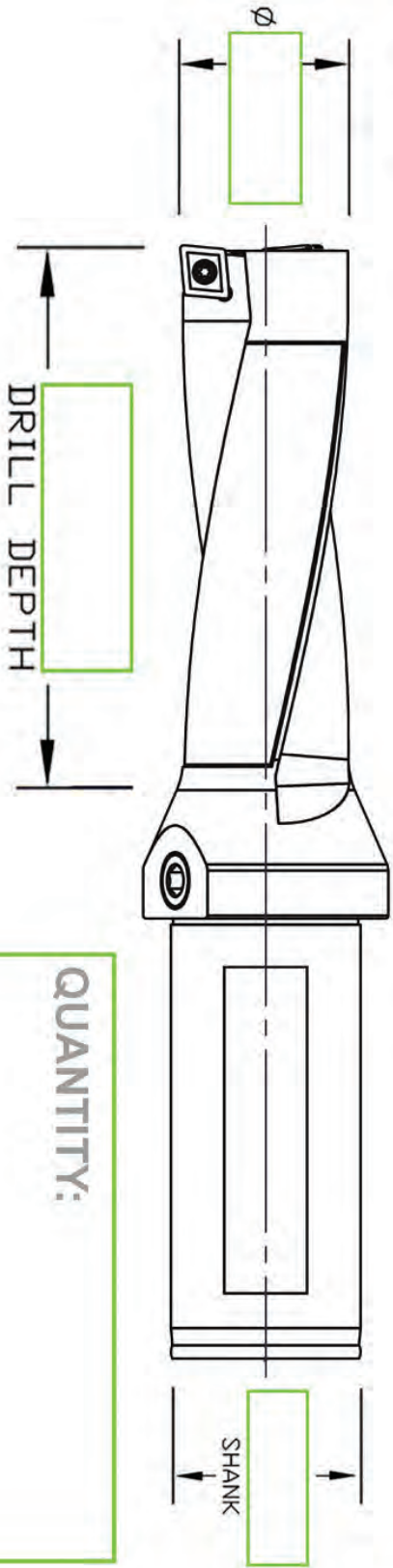

QUANTITY:



Hardware
pg: 186



Inserts
pg: 167

DRILLING

D

Indexable Drill CUSTOM Order

FAX TO 810.638.4001 FOR QUOTE

YOUR INFO:

COMPANY: _____

CONTACT: _____

PHONE: () _____

EXT.: _____

DATE: / /

*PREFERRED DISTRIBUTOR INFO:

COMPANY: _____

CONTACT: _____

PHONE: () _____

EXT.: _____

* If you do not have a preferred distributor, we can provide you with a list of distributors in your area to choose from.

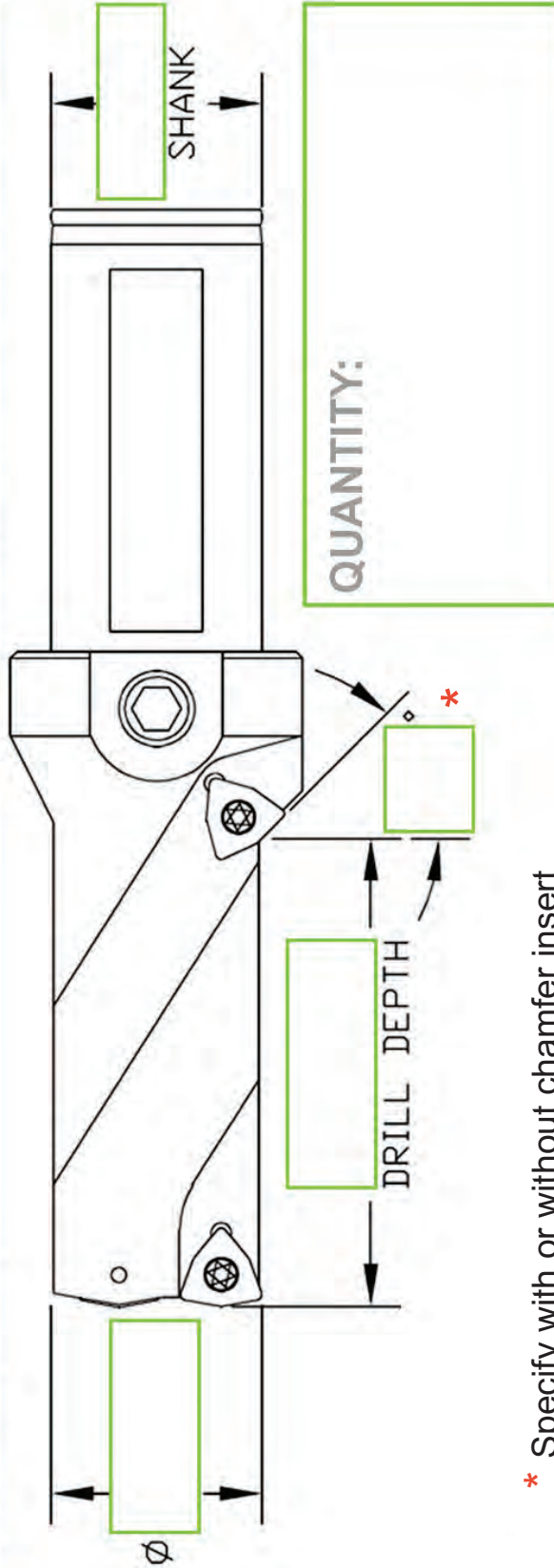

* Specify with or without chamfer insert

TOOL HOLDING



	CAT 40	CAT 50	HSK 40A	HSK 50A	HSK 63A	HSK 80A	HSK 100A	HSK 125A	Straight Shank
ER Collet Chuck	132	138	147	147	147	152	152	152	161
End Mill	133	139	--	--	148	--	153	--	--
Shell Mill	135	141	--	--	151	--	154	--	--
Shrink-Fit	136	142	--	--	149	--	155	--	--
Jacobs Taper	137	143	--	--	--	--	--	--	--
Blanks	137	143	151	151	151	154	154	154	--
Retention Knobs	144		HSK Coolant Tubes		157				
Tool Bushings	159		Shrink-Fit Extensions		158				
Collets	163								



TOOL HOLDING

 **Hardware**
pg: 186



CAT40 ER Collet Chucks

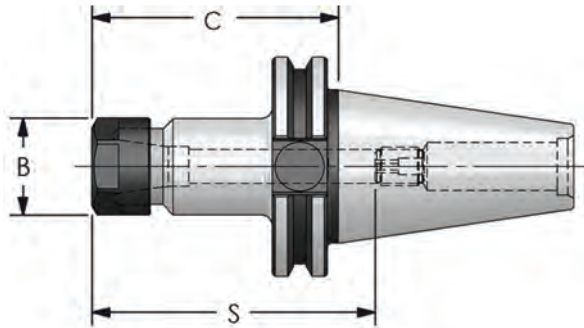

Balanced to:
G2.5 (20,000 rpm)
G6.3 (12,000 rpm)

CAT40 ER Collet Chucks

Designation	B Nut Dia.	C Proj.	S Max Depth	Collet Nut	Stop Screw	Wrench	G2 Price*	G6 Price*
CT40-ER11-250-G2/G6	.750	2.50	1.94	ER-11HN	ER-11S	ER-11W	\$138.00	\$114.00
CT40-ER11-400-G2/G6	.750	4.00	1.94	ER-11HN	ER-11S	ER-11W	\$141.00	\$116.00
CT40-ER11-600-G2/G6	.750	6.00	1.94	ER-11HN	ER-11S	ER-11W	\$159.00	\$135.00
CT40-ER16-250-G2/G6	1.100	2.50	3.00	ER-16HN	ER-16S	ER-16W	\$126.00	\$101.00
CT40-ER16-300-G2/G6	1.100	3.00	3.00	ER-16HN	ER-16S	ER-16W	\$138.00	\$114.00
CT40-ER16-400-G2/G6	1.100	4.00	3.00	ER-16HN	ER-16S	ER-16W	\$141.00	\$116.00
CT40-ER16-500-G2/G6	1.100	5.00	3.00	ER-16HN	ER-16S	ER-16W	\$148.00	\$124.00
CT40-ER16-600-G2/G6	1.100	6.00	3.00	ER-16HN	ER-16S	ER-16W	\$159.00	\$135.00
CT40-ER20-300-G2/G6	1.340	3.00	3.50	ER-20HN	ER-20S	ER-20W	\$138.00	\$114.00
CT40-ER20-400-G2/G6	1.340	4.00	3.95	ER-20HN	ER-20S	ER-20W	\$141.00	\$116.00
CT40-ER20-600-G2/G6	1.340	6.00	3.95	ER-20HN	ER-20S	ER-20W	\$159.00	\$135.00
CT40-ER20-800-G2/G6	1.340	8.00	3.95	ER-20HN	ER-20S	ER-20W	\$241.00	\$216.00
CT40-ER25-250-G2/G6	1.660	2.50	2.80	ER-25SN	ER-25S	ER-25W	\$142.00	\$117.00
CT40-ER25-400-G2/G6	1.660	4.00	4.30	ER-25SN	ER-25S	ER-25W	\$142.00	\$117.00
CT40-ER25-600-G2/G6	1.660	6.00	4.40	ER-25SN	ER-25S	ER-25W	\$154.00	\$130.00
CT40-ER32-300-G2/G6	1.980	3.00	3.45	ER-32SN	ER-32S	ER-32W	\$151.00	\$126.00
CT40-ER32-400-G2/G6	1.980	4.00	4.30	ER-32SN	ER-32S	ER-32W	\$151.00	\$126.00
CT40-ER32-600-G2/G6	1.980	6.00	4.60	ER-32SN	ER-32S	ER-32W	\$159.00	\$135.00
CT40-ER32-800-G2/G6	1.980	8.00	4.60	ER-32SN	ER-32S	ER-32W	\$259.00	\$235.00
CT40-ER40-300-G2/G6	2.250	3.00	3.30	ER-40SN	ER-40S	ER-40W	\$151.00	\$135.00
CT40-ER40-400-G2/G6	2.250	4.00	4.00	ER-40SN	ER-40S	ER-40W	\$151.00	\$135.00
CT40-ER40-600-G2/G6	2.250	6.00	4.50	ER-40SN	ER-40S	ER-40W	\$174.00	\$149.00
CT40-ER40-800-G2/G6	2.250	8.00	4.50	ER-40SN	ER-40S	ER-40W	\$259.00	\$235.00

* Add -G6 or -G2 to end of designation depending on the balance needed.

All Hardware Included. Wrenches Sold Separately.

MICHIGAN MADE

TOOL HOLDING

CAT40 End Mill Holders

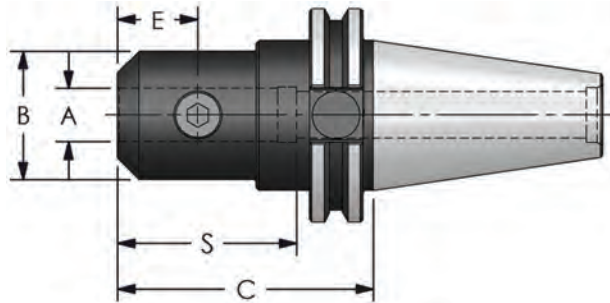

CAT40 End Mill Holders (1/8 - 1/2")

Balanced to:
G2.5 (20,000 rpm)
G6.3 (12,000 rpm)

Designation	A Inside Dia.	B Outside Dia.	C Proj.	S Max Depth	E	Set Screw	G2 Price*	G6 Price*
CT40-EM012-250-G2/G6	.125	.690	2.50	--	.19	SS10-250	\$117.00	\$93.00
CT40-EM188-250-G2/G6	.188	.750	2.50	--	.44	SS10-250	\$105.00	\$80.00
CT40-EM188-400-G2/G6	.188	.750	4.00	--	.44	SS10-250	\$135.00	\$110.00
CT40-EM250-250-G2/G6	.250	.880	2.50	--	.44	SS1/4-250	\$105.00	\$80.00
CT40-EM250-400-G2/G6	.250	.880	4.00	--	.44	SS1/4-250	\$121.00	\$96.00
CT40-EM250-600-G2/G6	.250	.880	6.00	--	.44	SS1/4-250	\$128.00	\$104.00
CT40-EM312-250-G2/G6	.312	.880	2.50	--	.44	SS1/4-250	\$105.00	\$80.00
CT40-EM312-400-G2/G6	.312	.880	4.00	--	.44	SS1/4-250	\$121.00	\$96.00
CT40-EM312-600-G2/G6	.312	.880	6.00	--	.44	SS1/4-250	\$128.00	\$104.00
CT40-EM375-250-G2/G6	.375	1.000	2.50	--	.75	SS3/8-375	\$105.00	\$80.00
CT40-EM375-400-G2/G6	.375	1.000	4.00	--	.75	SS3/8-375	\$121.00	\$96.00
CT40-EM375-600-G2/G6	.375	1.000	6.00	--	.75	SS3/8-375	\$121.00	\$96.00
CT40-EM437-250-G2/G6	.437	1.000	2.50	--	.75	SS3/8-375	\$105.00	\$80.00
CT40-EM437-400-G2/G6	.437	1.000	4.00	--	.75	SS3/8-375	\$128.00	\$104.00
CT40-EM500-262-G2/G6	.500	1.375	2.62	--	.88	SS7/16-500	\$105.00	\$80.00
CT40-EM500-400-G2/G6	.500	1.375	4.00	--	.88	SS7/16-500	\$121.00	\$96.00
CT40-EM500-600-G2/G6	.500	1.375	6.00	--	.88	SS7/16-500	\$128.00	\$104.00

* Add -G6 or -G2 to end of designation depending on the balance needed.
All Hardware Included

- Taper Ground to **AT-3** Specification
- Balanced for Less Vibration & Longer Tool Life
- T.I.R. .0002
- Hardened & Tempered to Prevent Taper Cracking
- Through Spindle Coolant Capability
- Special Length Projections Available

Retention
Knobs
pg 144



ULTRA-DEX



Hardware
pg: 186



Collets
pg: 184

Proudly Made in Flushing, MI USA 133

E

TOOL HOLDING

CAT40 End Mill Holders

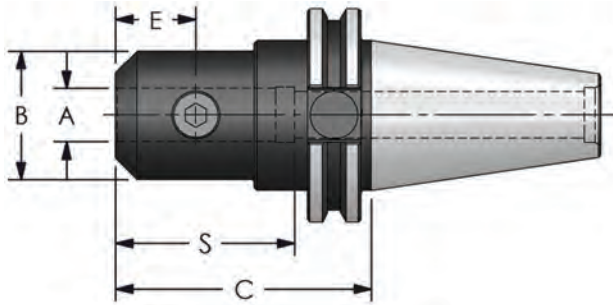

CAT40 End Mill Holders (9/16 - 1 1/2")

Balanced to:
G2.5 (20,000 rpm)
G6.3 (12,000 rpm)

Designation	A Inside Dia.	B Outside Dia.	C Proj.	S Max Depth	E	Set Screw	G2 Price*	G6 Price*
CT40-EM563-262-G2/G6	.563	1.375	2.62	2.05	.88	SS7/16-500	\$105.00	\$80.00
CT40-EM625-175-G2/G6	.625	1.750	1.75	2.10	.70	SS9/16-500	\$105.00	\$80.00
CT40-EM625-300-G2/G6	.625	1.500	3.00	2.10	.94	SS9/16-500	\$121.00	\$96.00
CT40-EM625-600-G2/G6	.625	1.500	6.00	2.10	.94	SS9/16-500	\$128.00	\$92.17
CT40-EM750-175-G2/G6	.750	1.750	1.75	2.25	.70	SS5/8-500	\$105.00	\$80.00
CT40-EM750-300-G2/G6	.750	1.750	3.00	2.30	1.00	SS5/8-500	\$121.00	\$96.00
CT40-EM750-600-G2/G6	.750	1.750	6.00	2.30	1.00	SS5/8-500	\$128.00	\$104.00
CT40-EM875-600-G2/G6	.875	2.000	6.00	2.50	1.00	SS5/8-500	\$128.00	\$104.00
CT40-EM100-175-G2/G6	1.000	1.750	1.75	2.25	.83	SS3/4-375	\$105.00	\$80.00
CT40-EM100-400-G2/G6	1.000	2.000	4.00	2.83	1.12	SS3/4-500	\$121.00	\$96.00
CT40-EM100-600-G2/G6	1.000	2.000	6.00	2.83	1.12	SS3/4-500	\$128.00	\$104.00
CT40-EM125-250-G2/G6	1.250	2.250	2.50	2.50	1.00	SS3/4-500	\$105.00	\$80.00
CT40-EM125-400-G2/G6	1.250	2.250	4.00	3.00	1.12	(2) SS3/4-500	\$121.00	\$96.00
CT40-EM125-600-G2/G6	1.250	2.250	6.00	3.00	1.12	(2) SS3/4-500	\$128.00	\$104.00
CT40-EM150-462-G2/G6	1.500	2.600	4.62	2.75	1.12	(2) SS3/4-500	\$121.00	\$96.00

* Add -G6 or -G2 to end of designation depending on the balance needed.
 All Hardware Included

E

TOOL HOLDING

SAME DAY SHIPPING!

On orders placed before 3:00pm EST
 SEE PAGE 190 for more details...

3:00

CAT40 Shell Mill Holders

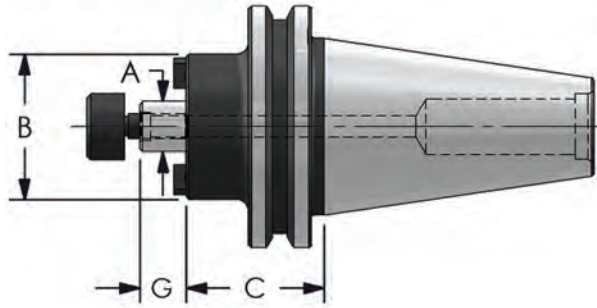

CAT40 Shell Mill Holders

Balanced to:
G6.3 (12,000 rpm)

Designation	A Pilot Dia.	B Diameter	C Projection	G	Drive Key	Lock Screw	Thread	Price
CT40-SM050-138	.500	1.438	1.38	.46	UDK 250	U5001	1/4-28	\$107.00
CT40-SM050-350	.500	1.438	3.50	.46	UDK 250	U5001	1/4-28	\$122.00
CT40-SM075-150	.750	1.750	1.50	.68	UDK 312	U5002	3/8-24	\$110.00
CT40-SM075-400	.750	1.750	4.00	.68	UDK 312	U5002	3/8-24	\$135.00
CT40-SM075-600	.750	1.750	6.00	.68	UDK 312	U5002	3/8-24	\$159.00
CT40-SM100-200	1.000	2.190	2.00	.68	UDK 375	U5003	1/2-20	\$114.00
CT40-SM100-400	1.000	2.190	4.00	.68	UDK 375	U5003	1/2-20	\$135.00
CT40-SM100-600	1.000	2.190	6.00	.68	UDK 375	U5003	1/2-20	\$178.00
CT40-SM125-212	1.250	2.750	2.12	.68	UDK 500	U5004	5/8-18	\$110.00
CT40-SM125-400	1.250	2.750	4.00	.68	UDK 500	U5004	5/8-18	\$127.00
CT40-SM150-250	1.500	3.380	2.50	.94	UDK 625	U5005	3/4-16	\$116.00
CT40-SM150-400	1.500	3.380	4.00	.94	UDK 625	U5005	3/4-16	\$132.00

All Hardware Included



- Taper Ground to **AT-3** Specification
- Balanced for Less Vibration & Longer Tool Life
- T.I.R. .0002
- Hardened & Tempered to Prevent Taper Cracking
- Through Spindle Coolant Capability
- Special Length Projections Available

Retention
Knobs
pg 144



 Hardware
pg: 186

ULTRA-DEX

Proudly Made in Flushing, MI USA 135

E

TOOL HOLDING

CAT40 Shrink-Fit Holders

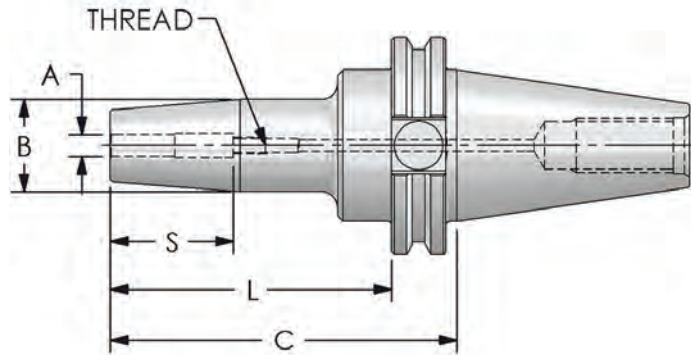

CAT40 Shrink-Fit Holders (Std. Length)

Balanced to:
G2.5 (20,000 rpm)

Designation	A Inside Dia.	B Outside Dia.	C Proj.	S	L	Thread	Price
CT40-SF012-400-G2	.125	.500	4.00	.79	3.25	--	\$203.00
CT40-SF188-400-G2	.188	.500	4.00	.79	3.25	--	\$190.00
CT40-SF250-400-G2	.250	.750	4.00	1.42	3.25	10-32	\$190.00
CT40-SF375-400-G2	.375	.750	4.00	1.53	3.25	1/4-28	\$190.00
CT40-SF500-400-G2	.500	1.000	4.00	1.85	3.25	7/16-20	\$196.00
CT40-SF625-400-G2	.625	1.000	4.00	1.97	3.25	9/16-18	\$196.00
CT40-SF750-400-G2	.750	1.250	4.00	2.04	3.25	5/8-18	\$209.00
CT40-SF100-400-G2	1.000	2.090	4.00	2.28	3.25	3/4-16	\$209.00
CT40-SF125-400-G2	1.250	2.090	4.00	2.28	3.25	3/4-16	\$209.00

CAT40 Shrink-Fit Holders (Ext. Length)

CT40-SF012-600-G2	.125	.750	6.00	.79	5.25	--	\$234.00
CT40-SF188-600-G2	.188	.750	6.00	.79	5.25	--	\$221.00
CT40-SF250-600-G2	.250	.750	6.00	1.42	5.25	10-32	\$221.00
CT40-SF375-600-G2	.375	1.000	6.00	1.53	5.25	1/4-28	\$221.00
CT40-SF500-600-G2	.500	1.000	6.00	1.85	5.25	7/16-20	\$221.00
CT40-SF625-600-G2	.625	1.250	6.00	1.97	5.25	9/16-18	\$227.00
CT40-SF750-600-G2	.750	1.250	6.00	2.04	5.25	5/8-18	\$227.00
CT40-SF100-600-G2	1.000	2.090	6.00	2.28	5.25	3/4-16	\$227.00
CT40-SF250-800-G2	.250	1.000	8.00	1.42	7.25	10-32	\$258.00



Shrink-Fit
Machines Available
Call for Pricing

TOOL HOLDING

CAT40 Jacobs Taper / BLANKS

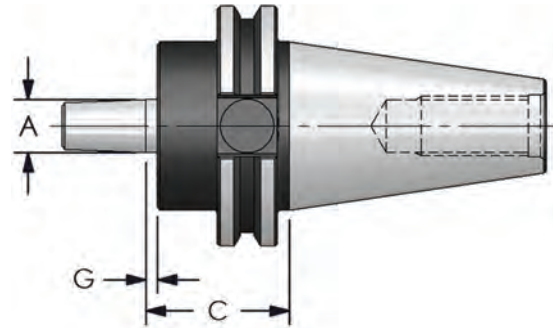

CAT40 Jacobs Taper Holders

Balanced to:
G6.3 (12,000 rpm)

Designation	Taper No.	C Projection	A Dia.	G	Taper Length	Price
CT40-JT02-150	2	1.50	.559	.125	.875	\$86.00
CT40-JT03-150	3	1.50	.811	.125	1.219	\$86.00
CT40-JT04-150	4	1.50	1.124	.125	1.656	\$86.00
CT40-JT06-150	6	1.50	.676	.125	1.000	\$86.00
CT40-JT33-150	33	1.50	.624	.125	1.000	\$89.00

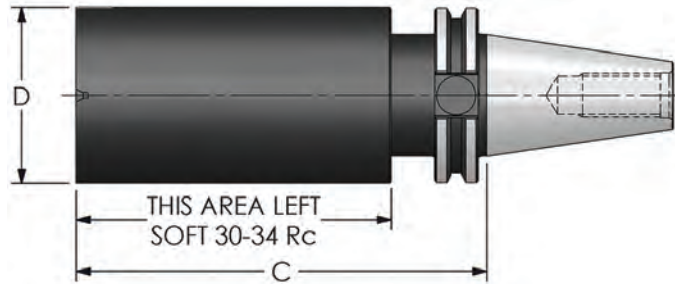

CAT40 Style Blanks

Designation	Taper	D		C		Price
		mm	Inch	mm	Inch	
CT40-BB64-150	CAT40	64	2.520	150	5.91	\$150.00
CT40-BB64-250	CAT40	64	2.520	250	9.84	\$175.00
CT40-BB100-150	CAT40	100	3.940	150	5.91	\$187.00

Retention Knobs
pg 144



Hardware
pg: 186



E

TOOL HOLDING



CAT50 ER Collet Chucks

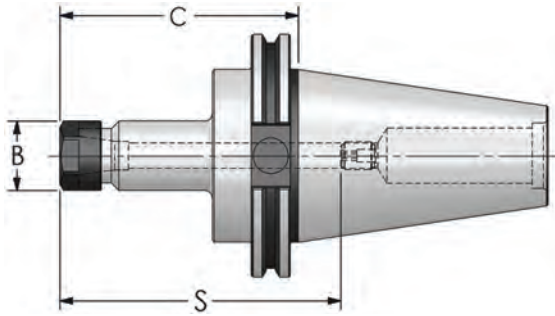

CAT50 ER Collet Chucks

Balanced to:
G2.5 (15,000 rpm)
G6.3 (12,000 rpm)

Designation	B Nut Dia.	C Proj.	S Max Depth	Collet Nut	Stop Screw	Wrench	G2 Price*	G6 Price*
CT50-ER11-600-G2/G6	.750	6.00	1.94	ER-11HN	ER-11S	ER-11W	\$284.00	\$259.00
CT50-ER16-400-G2/G6	1.100	4.00	4.50	ER-16HN	ER-16S	ER-16W	\$195.00	\$170.00
CT50-ER16-600-G2/G6	1.100	6.00	4.50	ER-16HN	ER-16S	ER-16W	\$209.00	\$184.00
CT50-ER16-800-G2/G6	1.100	8.00	4.50	ER-16HN	ER-16S	ER-16W	\$284.00	\$259.00
CT50-ER20-250-G2/G6	1.340	2.50	3.38	ER-20HN	ER-20S	ER-20W	\$195.00	\$170.00
CT50-ER20-400-G2/G6	1.340	4.00	4.00	ER-20HN	ER-20S	ER-20W	\$195.00	\$170.00
CT50-ER20-600-G2/G6	1.340	6.00	4.00	ER-20HN	ER-20S	ER-20W	\$214.00	\$189.00
CT50-ER20-800-G2/G6	1.340	8.00	4.00	ER-20HN	ER-20S	ER-20W	\$245.00	\$220.00
CT50-ER25-250-G2/G6	1.660	2.50	4.50	ER-25SN	ER-25S	ER-25W	\$200.00	\$175.00
CT50-ER25-400-G2/G6	1.660	4.00	4.50	ER-25SN	ER-25S	ER-25W	\$200.00	\$175.00
CT50-ER25-600-G2/G6	1.660	6.00	4.50	ER-25SN	ER-25S	ER-25W	\$217.00	\$193.00
CT50-ER25-800-G2/G6	1.660	8.00	4.50	ER-25SN	ER-25S	ER-25W	\$247.00	\$222.00
CT50-ER32-300-G2/G6	1.980	3.00	3.50	ER-32SN	ER-32S	ER-32W	\$196.00	\$172.00
CT50-ER32-400-G2/G6	1.980	4.00	4.00	ER-32SN	ER-32S	ER-32W	\$203.00	\$178.00
CT50-ER32-500-G2/G6	1.980	5.00	4.00	ER-32SN	ER-32S	ER-32W	\$210.00	\$185.00
CT50-ER32-600-G2/G6	1.980	6.00	4.00	ER-32SN	ER-32S	ER-32W	\$210.00	\$185.00
CT50-ER32-800-G2/G6	1.980	8.00	4.00	ER-32SN	ER-32S	ER-32W	\$290.00	\$266.00
CT50-ER40-300-G2/G6	2.500	3.00	4.00	ER-40SN	ER-40S	ER-40W	\$196.00	\$172.00
CT50-ER40-400-G2/G6	2.500	4.00	4.50	ER-40SN	ER-40S	ER-40W	\$210.00	\$185.00
CT50-ER40-500-G2/G6	2.500	5.00	4.50	ER-40SN	ER-40S	ER-40W	\$217.00	\$193.00
CT50-ER40-600-G2/G6	2.500	6.00	4.50	ER-40SN	ER-40S	ER-40W	\$224.00	\$199.00
CT50-ER40-800-G2/G6	2.500	8.00	4.50	ER-40SN	ER-40S	ER-40W	\$297.00	\$272.00

* Add -G6 or -G2 to end of designation depending on the balance needed.
All Hardware Included. Wrenches Sold Separately.



TM

TOOL HOLDING

CAT50 End Mill Holders

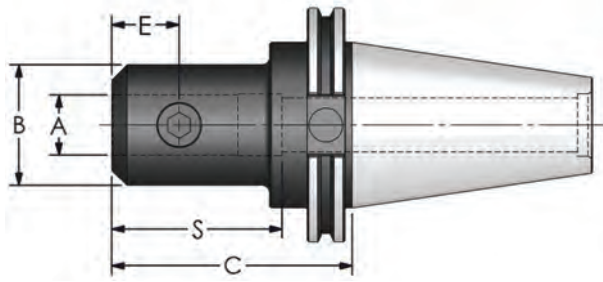

Balanced to:
G2.5 (15,000 rpm)
G6.3 (12,000 rpm)

CAT50 End Mill Holders (3/16 - 1/2")

Designation	A Inside Dia.	B Outside Dia.	C Proj.	S Max Depth	E	Set Screw	G2 Price*	G6 Price*
CT50-EM188-250-G2/G6	.188	.680	2.50	--	.44	SS10-250	\$135.00	\$111.00
CT50-EM188-400-G2/G6	.188	.680	4.00	--	.44	SS10-250	\$146.00	\$121.00
CT50-EM250-250-G2/G6	.250	.880	2.50	--	.44	SS1/4-250	\$135.00	\$111.00
CT50-EM250-400-G2/G6	.250	.880	4.00	--	.44	SS1/4-250	\$146.00	\$121.00
CT50-EM250-600-G2/G6	.250	.880	6.00	--	.44	SS1/4-250	\$159.00	\$135.00
CT50-EM312-250-G2/G6	.312	1.000	2.50	--	.44	SS1/4-250	\$135.00	\$111.00
CT50-EM312-400-G2/G6	.312	1.000	4.00	--	.44	SS1/4-250	\$146.00	\$121.00
CT50-EM312-600-G2/G6	.312	1.000	6.00	--	.44	SS1/4-250	\$159.00	\$135.00
CT50-EM375-250-G2/G6	.375	1.000	2.50	--	.75	SS3/8-375	\$135.00	\$111.00
CT50-EM375-400-G2/G6	.375	1.000	4.00	--	.75	SS3/8-375	\$146.00	\$121.00
CT50-EM375-600-G2/G6	.375	1.000	6.00	--	.75	SS3/8-375	\$159.00	\$135.00
CT50-EM437-250-G2/G6	.437	1.000	2.50	--	.75	SS3/8-375	\$135.00	\$111.00
CT50-EM437-400-G2/G6	.437	1.000	4.00	--	.75	SS3/8-375	\$170.00	\$142.00
CT50-EM437-600-G2/G6	.437	1.000	6.00	--	.75	SS3/8-375	\$183.00	\$154.00
CT50-EM500-262-G2/G6	.500	1.375	2.62	--	.88	SS7/16-500	\$135.00	\$111.00
CT50-EM500-400-G2/G6	.500	1.375	4.00	--	.88	SS7/16-500	\$146.00	\$121.00
CT50-EM500-600-G2/G6	.500	1.375	6.00	--	.88	SS7/16-500	\$159.00	\$135.00

* Add -G6 or -G2 to end of designation depending on the balance needed.
All Hardware Included



Retention
 Knobs
 pg 144



Hardware
 pg: 186

EM

TOOL HOLDING

CAT50 End Mill Holders

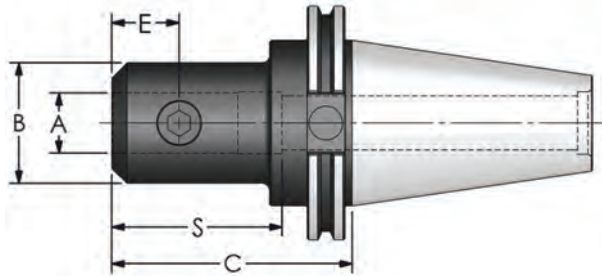

CAT50 End Mill Holders (5/8 - 2")

Balanced to:
G2.5 (15,000 rpm)
G6.3 (12,000 rpm)

Designation	A Inside Dia.	B Outside Dia.	C Proj.	S Max Depth	E	Set Screw	G2 Price*	G6 Price*
CT50-EM625-138-G2/G6	.625	2.750	1.38	--	.70	SS9/16-500	\$135.00	\$111.00
CT50-EM625-300-G2/G6	.625	1.750	3.00	--	.94	SS9/16-500	\$146.00	\$121.00
CT50-EM625-600-G2/G6	.625	1.750	6.00	--	.94	SS9/16-500	\$159.00	\$135.00
CT50-EM750-138-G2/G6	.750	2.750	1.38	--	.67	SS5/8-500	\$135.00	\$111.00
CT50-EM750-300-G2/G6	.750	1.750	3.00	--	.67	SS5/8-500	\$146.00	\$121.00
CT50-EM750-600-G2/G6	.750	1.750	6.00	--	1.00	SS5/8-500	\$159.00	\$135.00
CT50-EM875-400-G2/G6	.875	2.000	4.00	2.50	1.00	SS5/8-500	\$147.00	\$120.00
CT50-EM875-600-G2/G6	.875	2.000	6.00	2.50	1.00	SS5/8-500	\$157.00	\$128.00
CT50-EM100-138-G2/G6	1.000	2.750	1.38	2.25	.83	SS3/4-500	\$135.00	\$111.00
CT50-EM100-400-G2/G6	1.000	2.000	4.00	2.83	1.12	SS3/4-500	\$146.00	\$121.00
CT50-EM100-600-G2/G6	1.000	2.000	6.00	2.83	1.12	SS3/4-500	\$159.00	\$135.00
CT50-EM125-200-G2/G6	1.250	2.750	2.00	2.55	.88	SS3/4-750	\$142.00	\$117.00
CT50-EM125-400-G2/G6	1.250	2.750	4.00	3.00	1.12	(2) SS3/4-750	\$159.00	\$135.00
CT50-EM125-600-G2/G6	1.250	2.500	6.00	3.00	1.12	(2) SS3/4-750	\$178.00	\$153.00
CT50-EM150-200-G2/G6	1.500	2.750	2.00	2.75	1.12	SS3/4-500	\$142.00	\$117.00
CT50-EM150-450-G2/G6	1.500	2.500	4.50	2.75	1.12	(2) SS3/4-500	\$159.00	\$135.00
CT50-EM200-500-G2/G6	2.000	3.750	5.00	3.50	1.41	(2) SS1-750	\$158.00	\$130.00
CT50-EM200-800-G2/G6	2.000	3.750	8.00	3.50	1.41	(2) SS1-750	\$189.00	\$162.00

* Add -G6 or -G2 to end of designation depending on the balance needed.

All Hardware Included

- Taper Ground to **AT-3** Specification
- Balanced for Less Vibration & Longer Tool Life
- T.I.R. .0002
- Hardened & Tempered to Prevent Taper Cracking
- Through Spindle Coolant Capability
- Special Length Projections Available

TOOL HOLDING

CAT50 Shell Mill Holders

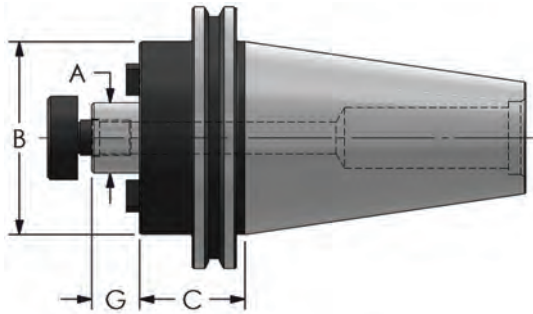

CAT50 Shell Mill Holders

Balanced to:
G6.3 (12,000 rpm)

Designation	A Pilot Dia.	B Diameter	C Projection	G	Drive Key	Lock Screw	Thread	Price
CT50-SM050-200	.500	1.560	2.00	.46	UDK 250	U5001	1/4-28	\$137.00
CT50-SM050-400	.500	1.560	4.00	.46	UDK 250	U5001	1/4-28	\$158.00
CT50-SM050-600	.500	1.560	6.00	.46	UDK 250	U5001	1/4-28	\$178.00
CT50-SM075-150	.750	2.750	1.50	.68	UDK 312	U5002	3/8-24	\$137.00
CT50-SM075-400	.750	1.750	4.00	.68	UDK 312	U5002	3/8-24	\$158.00
CT50-SM075-600	.750	1.750	6.00	.68	UDK 312	U5002	3/8-24	\$178.00
CT50-SM100-150	1.000	2.750	1.50	.68	UDK 375	U5003	1/2-20	\$137.00
CT50-SM100-400	1.000	2.750	4.00	.68	UDK 375	U5003	1/2-20	\$158.00
CT50-SM100-600	1.000	2.750	6.00	.68	UDK 375	U5003	1/2-20	\$178.00
CT50-SM125-150	1.250	2.750	1.50	.68	UDK 500	U5004	5/8-18	\$137.00
CT50-SM125-400	1.250	2.750	4.00	.68	UDK 500	U5004	5/8-18	\$158.00
CT50-SM125-600	1.250	2.750	6.00	.68	UDK 500	U5004	5/8-18	\$178.00
CT50-SM150-250	1.500	3.750	2.50	.94	UDK 625	U5005	3/4-16	\$136.00
CT50-SM150-400	1.500	3.750	4.00	.94	UDK 625	U5005	3/4-16	\$158.00
CT50-SM150-600	1.500	3.750	6.00	.94	UDK 625	U5005	3/4-16	\$179.00
CT50-SM200-250	2.000	4.440	2.50	.94	UDK 750	U5006	1-14	\$163.00
CT50-SM200-400	2.000	4.440	4.00	.94	UDK 750	U5006	1-14	\$190.00
CT50-SM200-600	2.000	4.440	6.00	.94	UDK 750	U5006	1-14	\$224.00
CT50-SM250-250*	2.500	4.880	2.50	.94	UDK 100	U5007	1-14	\$220.00
CT50-SM250-400*	2.500	4.880	4.00	.94	UDK 100	U5007	1-14	\$261.00
CT50-SM250-600*	2.500	4.880	6.00	.94	UDK 100	U5007	1-14	\$316.00

* Features x4 5/8-11 tapped holes on a 4" bolt circle.
All Hardware Included

Retention Knobs pg 144



Hardware pg: 186



U

TOOL HOLDING

ULTRA-DEX

Proudly Made in Flushing, MI USA 141

CAT50 Shrink-Fit Holders

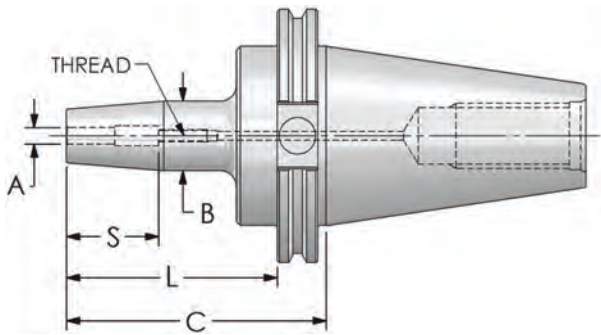

Shrink-Fit Machines Available
Call for Pricing

CAT50 Shrink-Fit Holders (Std. Length)

Balanced to:
G2.5 (20,000 rpm)

Designation	A Inside Dia.	B Outside Dia.	C Proj.	S	L	Thread	Price
CT50-SF012-400-G2	.125	.787	4.00	.375	3.250	--	\$271.00
CT50-SF188-400-G2	.188	.750	4.00	.563	3.250	--	\$258.00
CT50-SF250-400-G2	.250	.750	4.00	1.420	3.250	10-32	\$258.00
CT50-SF375-400-G2	.375	.750	4.00	1.530	3.250	1/4-28	\$258.00
CT50-SF500-400-G2	.500	1.000	4.00	1.850	3.250	7/16-20	\$271.00
CT50-SF625-400-G2	.625	1.000	4.00	1.970	3.250	9/16-18	\$271.00
CT50-SF750-400-G2	.750	1.250	4.00	2.040	3.250	5/8-18	\$271.00
CT50-SF100-400-G2	1.000	2.090	4.00	2.280	3.250	3/4-16	\$283.00
CT50-SF125-400-G2	1.250	2.090	4.00	2.280	3.250	3/4-16	\$283.00

CAT50 Shrink-Fit Holders (Ext. Length)

CT50-SF250-600-G2	.250	.750	6.00	1.420	5.625	10-32	\$308.00
CT50-SF375-600-G2	.375	1.000	6.00	1.530	5.625	1/4-28	\$308.00
CT50-SF500-600-G2	.500	1.000	6.00	1.850	5.625	7/16-20	\$308.00
CT50-SF625-600-G2	.625	1.250	6.00	1.970	5.625	9/16-18	\$320.00
CT50-SF750-600-G2	.750	1.250	6.00	2.040	5.625	5/8-18	\$320.00
CT50-SF250-800-G2	.250	1.000	8.00	1.420	8.300	10-32	\$345.00
CT50-SF375-800-G2	.375	1.250	8.00	1.530	5.625	1/4-28	\$357.00
CT50-SF500-800-G2	.500	1.250	8.00	1.850	5.625	7/16-20	\$357.00

- BEST Possible T.I.R.
- BEST Available Gripping Power
- BEST Possible Balance
- Fastest Tool Change - In Seconds!
- Ability to Preset for Required Tool Length
- Increased Tool and Spindle Life



TOOL HOLDING

CAT50 Jacobs Taper / BLANKS

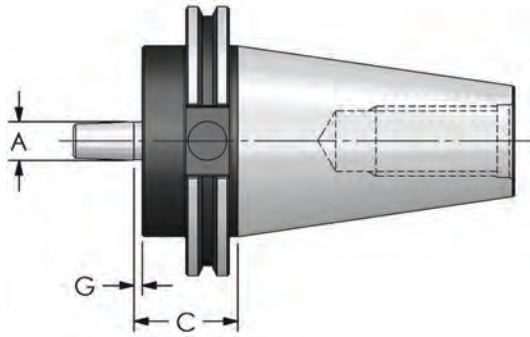

CAT50 Jacobs Taper Holders

Balanced to:
G6.3 (12,000 rpm)

Designation	Taper No.	C Projection	A Dia.	G	Taper Length	Price
CT50-JT02-150	2	1.50	.559	.125	.875	\$104.00
CT50-JT03-150	3	1.50	.811	.125	1.219	\$104.00
CT50-JT04-150	4	1.50	1.124	.125	1.656	\$104.00
CT50-JT06-150	6	1.50	.676	.125	1.000	\$104.00
CT50-JT33-150	33	1.50	.624	.125	1.000	\$116.00

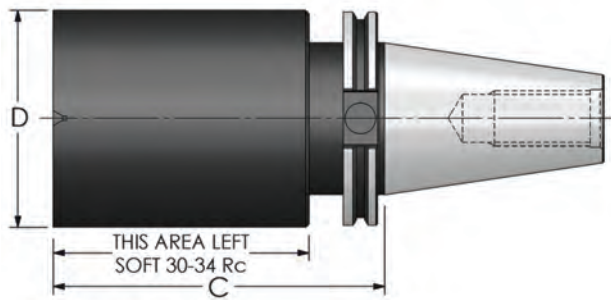

CAT50 Style Blanks

Designation	Taper	D		C		Price
		mm	Inch	mm	Inch	
CT50-BB100-150	CAT50	100	3.940	150	5.91	\$213.00
CT50-BB100-250	CAT50	100	3.940	250	9.84	\$267.00
CT50-BB150-150	CAT50	150	5.910	150	5.91	\$350.00

- Taper Ground to **AT-3** Specification
- Balanced for Less Vibration & Longer Tool Life
- T.I.R. .0002
- Hardened & Tempered to Prevent Taper Cracking
- Through Spindle Coolant Capability
- Special Length Projections Available

E

TOOL HOLDING



Hardware
pg: 186



CAT Retention Knobs

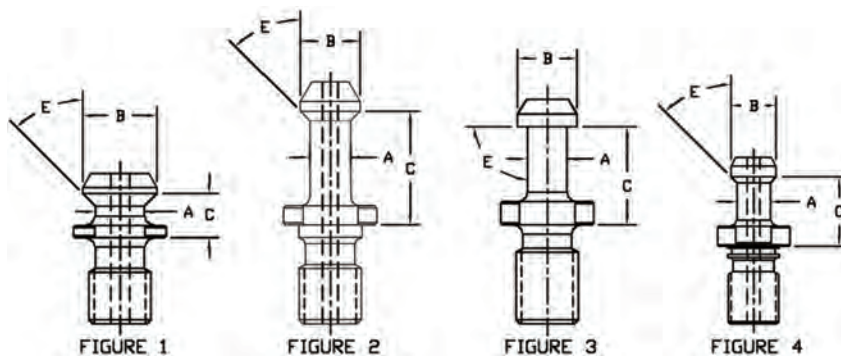

Designation	A	B	C	E	Thread	Coolant Thru	Figure	Price
PSC-475	.490	.740	.440	45°	5/8-11	YES	1	\$13.00
PS-475	.490	.740	.440	45°	5/8-11	NO	1	\$11.10
PS-532x15	.551	.747	.791	75°	5/8-11	NO	1	\$13.00
PSC-532x45	.392	.591	.984	45°	5/8-11	YES	2	\$14.00
PS-532x45	.392	.591	.984	45°	5/8-11	NO	2	\$13.00
PS-532x60	.392	.591	.984	60°	5/8-11	NO	2	\$13.00
PS-532x90	.392	.591	.984	90°	5/8-11	NO	2	\$13.00
PS-498	.392	.591	.775	90°	5/8-11	NO	3	\$14.00
PSC-552	.406	.594	1.139	45°	5/8-11	YES	2	\$16.00
PS-552	.406	.594	1.139	45°	5/8-11	NO	2	\$15.00

CAT40 Retention Knobs

Designation	A	B	C	E	Thread	Coolant Thru	Figure	Price
PSC-535x45	.667	.904	1.384	45°	1-8	YES	4	\$23.00
PS-535x45	.667	.904	1.384	45°	1-8	NO	4	\$21.00
PSC-536x45	.667	.904	1.384	45°	1-8	YES	2	\$21.00
PS-536x45	.667	.904	1.384	45°	1-8	NO	2	\$18.00
PS-536x60	.667	.904	1.384	60°	1-8	NO	2	\$18.00
PS-536x90	.667	.904	1.384	90°	1-8	NO	2	\$18.00
PSC-274	.820	1.140	.700	45°	1-8	YES	1	\$22.00
PS-274	.820	1.140	.700	45°	1-8	NO	1	\$20.00
PSC-271x15	.826	1.102	1.350	15°	1-8	YES	1	\$21.00

CAT50 Retention Knobs

Quick Reference Guide - Following page Machine Cross Reference

Each CAT taper machine requires its own style retention knob, on the following page is a general quick reference of the most common manufacturers. Be sure to check which knob your machine requires to ensure proper fit.

CAT40

PSC-475 Fits Cincinnati Milacron, Maho, Mazak, Matsura

PS-475 Fits Acroloc-Bayer, Maho, Mazak

PSC-532x45 Fits Amura-Seiki, Comet, Daewoo, Dah Lih, Haas, Howa Kogyo, Ikegai, Kearny-Trecker, Kia, Kitamura, Miyano, Okuma Howa, YCI

PS-532x45 Fits Amura-Seiki, Comet, Daewoo, Dah Lih, Haas, Howa Kogyo, Ikegai, Kearny-Trecker, Kia, Kitamura, Miyano, Okuma Howa, YCI

PS-532x60 Fits Hitachi-Seiki, Kia, Mitsubishi, Okuma, Matsura, Howa Kogyo, Milltronic

PS-532x90 Fits Kia, Mori Seiki

PS-498 Fits Mazak

PS-552 Fits Cincinnati Milacron

PSC-552 Fits Cincinnati Milacron

CAT50

PS-536x45 Fits Dah Lih, Haas, Ikegai, Kitamura, LeBlond Makino, YCI

PSC-536x45 Fits Haas, LeBlond Makino

PS-536x60 Fits Mitsubishi, Okuma, Matsura

PS-536x90 Fits Hitachi-Seiki, Mori Seiki, Mazak

PS-274 Fits Mazak

PSC-274 Fits Burgmaster, Devlieg, Exello, Maho, Matsura, Mazak



PLEASE NOTE: Retention knobs are available in many different types and sizes. Ultra-Dex USA has provided a list with common machines that fit each of our knobs. Due to the vast amount of machines, please check each machine to verify that you are ordering the proper knob. Retention knob dimensions for each machine can be typically found in the user manual or next to the power supply.

CAT 40 Machine Cross Reference

MANUFACTURER	DESIGNATION									
	PSC-475	PS-475	PS-532x15	PSC-532x45	PS-532x45	PS-532x60	PS-532x90	PS-498	PSC-552	PS-552
ACROLOC-BAYER	X	X								
ATRUMP				X	X					
BRIDGEPORT	X	X								
CARMAN	X	X								
CHEVALIER				X	X					
CHIRON	X	X								
CINCINNATI	X	X							X	X
COMET				X	X					
DAEWOO				X	X					
DAH LIH				X	X					
DOOSAN			X							
ENSHU				X	X	X				
EXCEL				X	X					
FADAL	X	X								
HAAS				X	X					
HAMAI				X	X					
HITACHI-SEIKI				X	X	X				
HOWA KOGYO				X	X					
HURCO	X	X		X						
IKEGAI				X	X					
JOHNFORD				X	X					
KASHAHARA				X	X					
KEARNY-TRECKER				X	X					
KIA				X	X		X			
KITAMURA				X	X					
KIWA				X	X					
LEBLOND MAKINO			X	X	X					
MAHO	X	X								
MASCO	X	X								
MATSUURA			X			X				
MAZAK	X	X								
MILLPORT				X	X					
MILLTRONICS	X					X				
MITSUBISHI						X				
MIYANO				X	X					
MORI SEIKI							X			
NOMURA						X				
OKUMA						X				
OKUMA HOWA				X	X					
OOYA				X	X					
OSAKA KIKO				X	X		X			
PRATT & WHITNEY	X			X	X					
ROKU-ROKU				X	X					
SAEILO				X	X					
SAKAZAKI				X	X	X				
SHARONA				X	X					
SHARP	X	X								
SHIZUOKA				X	X					
SHODA				X	X					
STAMA	X	X								
TAKISAWA				X	X					
TOSHIBA				X	X					
TOYAMA				X	X					
TOYO				X	X					
TOYODA				X	X					
TREE	X	X								
ULTRAMILL				X	X					
URAWA				X	X					
VULCAN				X	X					
YAM (YANG)							X			
YASDA				X	X					
YCI				X	X					

Quick Reference Guide

Each CAT taper machine requires its own style retention knob. Be sure to check which knob your machine requires to ensure proper fit.

See ultradexusa.com for more details



TOOL HOLDING

CAT 50 Machine Cross Reference

MANUFACTURER	DESIGNATION								
	PSC-535x45	PS-535x45	PSC-536x45	PS-536x45	PS-536x60	PS-536x90	PSC-274	PS-274	PSC-271x15
AMJURA-SEIKI	X	X	X	X					
DAH LIH	X	X	X	X					
ENSHU					X				
FADAL							X	X	
HAAS	X	X	X	X					
HAMAI	X	X	X	X					
HITACHI-SEIKI					X	X			
IKEGAI	X	X	X	X					
JOHNFORD	X	X							
KITAMURA	X	X	X	X					
KURAKI	X	X	X	X					
LEBLOND MAKINO	X	X	X	X					
MIGHTY	X	X	X	X					
MILLTRONICS							X	X	
MITSUBISHI	X	X	X	X					
MORI-SEIKI						X			
OKUMA					X				

Quick Reference Guide

Each CAT taper machine requires its own style retention knob. Be sure to check which knob your machine requires to ensure proper fit.

See ultradexusa.com for more details

SAME DAY SHIPPING!

On orders placed before 3:00pm EST

SEE PAGE 190 for more details...



E

TOOL HOLDING



HSK40-63A ER Collet Chucks

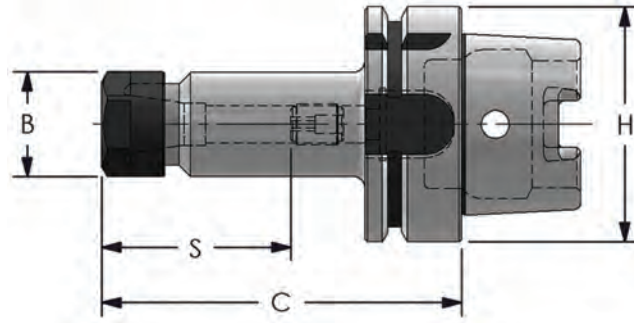

Balanced to:
G2.5 (20,000 rpm)
G6.3 (12,000 rpm)

HSK40A ER Collet Chucks

Designation	B Nut Dia.	C Proj.	S Max Depth	H	Collet Nut	Stop Screw	Wrench	G2 Price*	G6 Price*
HSK40A-ER11-250-G2/G6	.750	2.50	1.50	1.57	ER-11HN	ER-11S	ER-11W	\$257.00	\$232.00
HSK40A-ER16-300-G2/G6	1.100	3.00	1.70	1.57	ER-16HN	ER-16S	ER-16W	\$257.00	\$232.00
HSK40A-ER32-300-G2/G6	1.980	3.00	1.62	1.57	ER-32SN	ER-32S	ER-32W	\$269.00	\$245.00

HSK50A ER Collet Chucks

Designation	B Nut Dia.	C Proj.	S Max Depth	H	Collet Nut	Stop Screw	Wrench	G2 Price*	G6 Price*
HSK50A-ER16-300-G2/G6	1.100	3.00	1.61	1.97	ER-16HN	ER-16S	ER-16W	\$308.00	\$283.00
HSK50A-ER32-300-G2/G6	1.980	3.00	1.50	1.97	ER-32SN	ER-32S	ER-32W	\$320.00	\$295.00

HSK63A ER Collet Chucks

Designation	B Nut Dia.	C Proj.	S Max Depth	H	Collet Nut	Stop Screw	Wrench	G2 Price*	G6 Price*
HSK63A-ER11-600-G2/G6	.750	6.00	1.94	2.48	ER-11HN	ER-11S	ER-11W	\$289.00	\$264.00
HSK63A-ER16-400-G2/G6	1.100	4.00	3.00	2.48	ER-16HN	ER-16S	ER-16W	\$252.00	\$227.00
HSK63A-ER16-600-G2/G6	1.100	6.00	3.00	2.48	ER-16HN	ER-16S	ER-16W	\$277.00	\$252.00
HSK63A-ER32-400-G2/G6	1.980	4.00	4.30	2.48	ER-32SN	ER-32S	ER-32W	\$264.00	\$240.00
HSK63A-ER32-600-G2/G6	1.980	6.00	4.30	2.48	ER-32SN	ER-32S	ER-32W	\$289.00	\$264.00
HSK63A-ER40-400-G2/G6	2.250	4.00	4.00	2.48	ER-40SN	ER-40S	ER-40W	\$283.00	\$258.00
HSK63A-ER40-600-G2/G6	2.250	6.00	4.50	2.48	ER-40SN	ER-40S	ER-40W	\$308.00	\$283.00

* Add -G6 or -G2 to end of designation depending on the balance needed.
All Hardware Included. Wrenches Sold Separately.

TOOL HOLDING



Hardware
 pg: 186

ULTRA-DEX

Proudly Made in Flushing, MI USA 147

HSK63A End Mill Holders

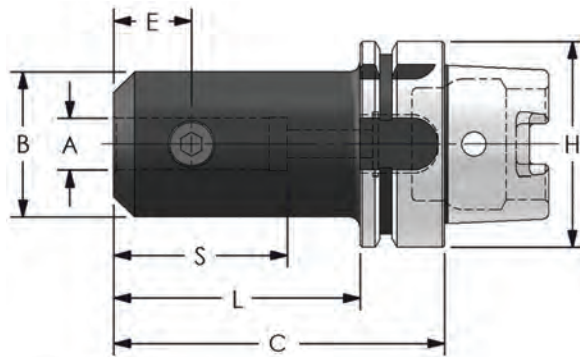

HSK63A End Mill Holders

Balanced to:
G2.5 (20,000 rpm)
G6.3 (12,000 rpm)

Designation	A Inside Dia.	B Outside Dia.	C Proj.	S Max Depth	E	H	L	Set Screw	G2 Price*	G6 Price*
HSK63A-EM250-300-G2/G6	.250	.880	3.00	--	.44	2.48	1.98	SS1/4-250	\$221.00	\$196.00
HSK63A-EM250-600-G2/G6	.250	.880	6.00	--	.44	2.48	4.98	SS1/4-250	\$271.00	\$246.00
HSK63A-EM375-300-G2/G6	.375	1.000	3.00	--	.75	2.48	1.98	SS3/8-375	\$221.00	\$196.00
HSK63A-EM375-600-G2/G6	.375	1.000	6.00	--	.75	2.48	4.98	SS3/8-375	\$271.00	\$246.00
HSK63A-EM500-300-G2/G6	.500	1.375	3.00	--	.88	2.48	1.98	SS7/16-500	\$221.00	\$196.00
HSK63A-EM500-600-G2/G6	.500	1.375	6.00	--	.88	2.48	4.98	SS7/16-500	\$271.00	\$246.00
HSK63A-EM625-300-G2/G6	.625	1.750	3.00	2.10	.94	2.48	1.98	SS9/16-500	\$221.00	\$196.00
HSK63A-EM625-600-G2/G6	.625	1.750	6.00	2.10	.94	2.48	4.98	SS9/16-500	\$271.00	\$246.00
HSK63A-EM750-300-G2/G6	.750	1.750	3.00	2.05	1.00	2.48	1.98	SS5/8-500	\$221.00	\$196.00
HSK63A-EM750-600-G2/G6	.750	1.750	6.00	2.30	1.00	2.48	4.98	SS5/8-500	\$271.00	\$246.00
HSK63A-EM100-425-G2/G6	1.000	2.250	4.25	2.83	1.12	2.48	3.23	SS3/4-500	\$234.00	\$209.00
HSK63A-EM100-600-G2/G6	1.000	2.250	6.00	2.83	1.12	2.48	4.98	SS3/4-500	\$288.00	\$263.00
HSK63A-EM125-425-G2/G6	1.250	2.250	4.25	3.00	1.12	2.48	3.23	(2) SS3/4-500	\$234.00	\$209.00
HSK63A-EM125-600-G2/G6	1.250	2.250	6.00	3.00	1.12	2.48	4.98	(2) SS3/4-500	\$288.00	\$263.00

* Add -G6 or -G2 to end of designation depending on the balance needed.

All Hardware Included

- DIN 69893 Specification
- Harnesses Centrifugal Forces to Increase Joint Strength
- Highest Static and Dynamic Rigidity
- Lowest Load for the Spindle Bearing
- Lowest Tool Runout
- Hardened and Tempered to Prevent Cracking
- Through Spindle Coolant Capability

TOOL HOLDING

HSK63A Shrink-Fit Holders (English)

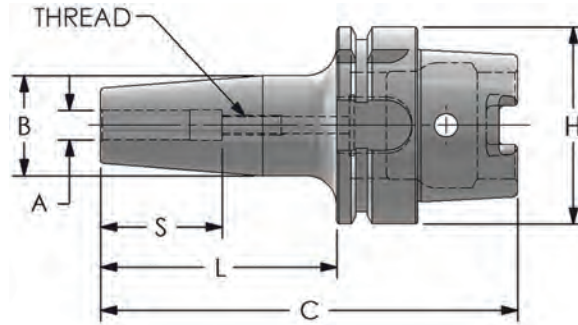

HSK63A Shrink-Fit Holders (Std. Length)

Balanced to:
G2.5 (20,000 rpm)

Designation	A Inside Dia.	B Outside Dia.	C Proj.	S	L	H	Thread	Price
HSK63A-SF012-400-G2	.125	1.063	4.00	.79	2.98	2.48	--	\$271.00
HSK63A-SF188-400-G2	.188	1.063	4.00	.79	2.98	2.48	--	\$246.00
HSK63A-SF250-400-G2	.250	1.063	4.00	1.42	2.98	2.48	--	\$246.00
HSK63A-SF375-400-G2	.375	1.260	4.00	1.53	2.98	2.48	1/4-28	\$246.00
HSK63A-SF500-400-G2	.500	1.339	4.00	1.85	2.98	2.48	7/16-20	\$246.00
HSK63A-SF625-400-G2	.625	1.339	4.00	1.97	2.98	2.48	9/16-18	\$246.00
HSK63A-SF750-400-G2	.750	1.654	4.00	2.04	2.98	2.48	5/8-18	\$246.00
HSK63A-SF100-500-G2	1.000	2.087	5.00	2.28	3.98	2.48	3/4-16	\$258.00
HSK63A-SF125-500-G2	1.250	2.087	5.00	2.28	3.98	2.48	3/4-16	\$258.00

HSK63A Shrink-Fit Holders (Ext. Length)

Designation	A Inside Dia.	B Outside Dia.	C Proj.	S	L	H	Thread	Price
HSK63A-SF375-600-G2	.375	1.260	6.00	1.53	4.98	2.48	1/4-28	\$283.00
HSK63A-SF500-600-G2	.500	1.339	6.00	1.85	4.98	2.48	7/16-20	\$283.00
HSK63A-SF750-600-G2	.750	1.654	6.00	2.04	4.98	2.48	5/8-18	\$283.00
HSK63A-SF100-700-G2	1.000	2.087	7.00	2.28	5.98	2.48	3/4-16	\$295.00

- BEST Possible T.I.R.
- BEST Available Gripping Power
- BEST Possible Balance
- Fastest Tool Change - In Seconds!
- Ability to Preset for Required Tool Length
- Increased Tool and Spindle Life



ULTRA-DEX



Hardware
pg: 186



Collets
pg: 163

Proudly Made in Flushing, MI USA 149

E

TOOL HOLDING

HSK63A Shrink-Fit Holders (Metric)

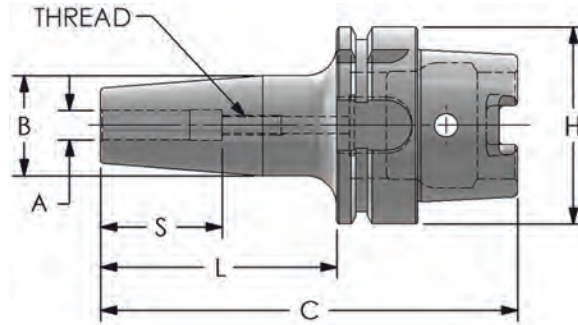

METRIC

HSK63A Shrink-Fit Holders (Std. Length)

Balanced to:
G2.5 (20,000 rpm)

Designation	A Inside Dia.	B Outside Dia.	C Proj.	S	L	H	Thread	Price
HSK63A-SF06-400-G2	6mm	1.063	4.00	2.167	2.98	2.478	10-32	\$246.00
HSK63A-SF08-400-G2	8mm	1.063	4.00	1.970	2.98	2.478	1/4-28	\$246.00
HSK63A-SF10-400-G2	10mm	1.260	4.00	2.207	2.98	2.478	1/4-28	\$246.00
HSK63A-SF12-400-G2	12mm	1.260	4.00	2.404	2.98	2.478	7/16-20	\$246.00
HSK63A-SF16-400-G2	16mm	1.339	4.00	2.522	2.98	2.478	9/16-18	\$246.00
HSK63A-SF20-400-G2	20mm	1.654	4.00	2.600	2.98	2.478	5/8-18	\$246.00
HSK63A-SF25-500-G2	25mm	2.087	5.00	2.912	3.98	2.478	3/4-16	\$258.00

HSK63A Shrink-Fit Holders (Ext. Length)

Designation	A Inside Dia.	B Outside Dia.	C Proj.	S	L	H	Thread	Price
HSK63A-SF06-600-G2	6mm	1.063	6.00	2.167	4.98	2.478	10-32	\$283.00
HSK63A-SF08-600-G2	8mm	1.063	6.00	1.970	4.98	2.478	1/4-28	\$283.00
HSK63A-SF10-600-G2	10mm	1.260	6.00	2.207	4.98	2.478	1/4-28	\$283.00
HSK63A-SF12-600-G2	12mm	1.260	6.00	2.404	4.98	2.478	7/16-20	\$283.00
HSK63A-SF16-600-G2	16mm	1.260	6.00	2.522	4.98	2.478	9/16-18	\$283.00
HSK63A-SF20-600-G2	20mm	1.654	6.00	2.600	4.98	2.478	5/8-18	\$283.00
HSK63A-SF25-700-G2	25mm	2.087	7.00	2.912	5.98	2.478	3/4-16	\$283.00



Shrink-Fit
Machines Available
Call for Pricing



TOOL HOLDING

HSK63A Shell Mill Holders / BLANKS

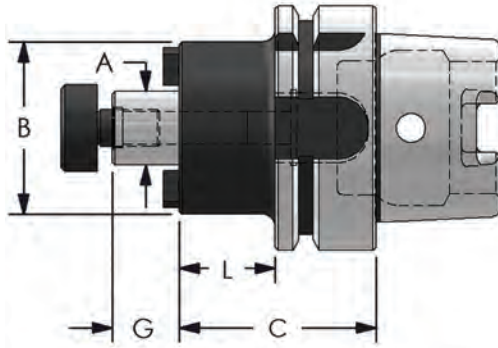

HSK63A Shell Mill Holders

Balanced to:
G6.3 (12,000 rpm)

Designation	A Pilot Dia.	B Dia.	C Proj.	G	H	L	Drive Key	Lock Screw	Thread	Price
HSK63A-SM075-200	.750	1.750	2.00	.68	2.48	.98	UDK 312	U5002	3/8-24	\$283.00
HSK63A-SM100-250	1.000	2.190	2.50	.68	2.48	1.48	UDK 375	U5003	1/2-20	\$289.00
HSK63A-SM125-250	1.250	2.750	2.50	.68	2.48	1.48	UDK 500	U5004	5/8-18	\$301.00
HSK63A-SM150-250	1.500	3.380	2.50	.94	2.48	1.48	UDK 625	U5005	3/4-16	\$320.00

All Hardware Included

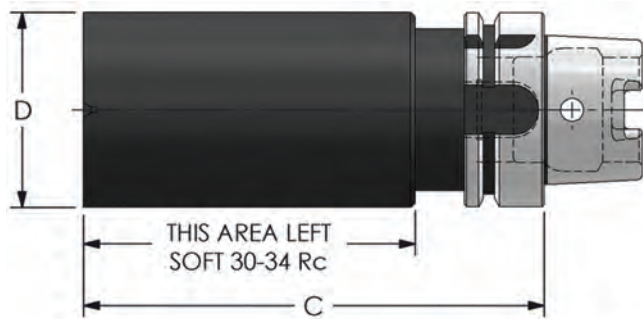

HSK Style Blanks

Designation	Taper	D		C		Price
		mm	Inch	mm	Inch	
HSK40A-BB50-120	HSK40A	50	1.970	120	4.72	\$200.00
HSK50A-BB50-150	HSK50A	50	1.970	150	5.91	\$213.00
HSK50A-BB75-200	HSK50A	75	2.950	200	7.87	\$263.00
HSK50A-BB100-125	HSK50A	100	3.940	125	4.92	\$263.00
HSK63A-BB64-150	HSK63A	64	2.520	150	5.91	\$263.00
HSK63A-BB64-250	HSK63A	64	2.520	250	9.84	\$288.00
HSK63A-BB89-89	HSK63A	89	3.500	89	3.50	\$288.00
HSK63A-BB125-150	HSK63A	125	4.920	150	5.91	\$373.00

E

TOOL HOLDING



Hardware
pg: 186



Proudly Made in Flushing, MI USA 151

HSK80-125A ER Collet Chucks

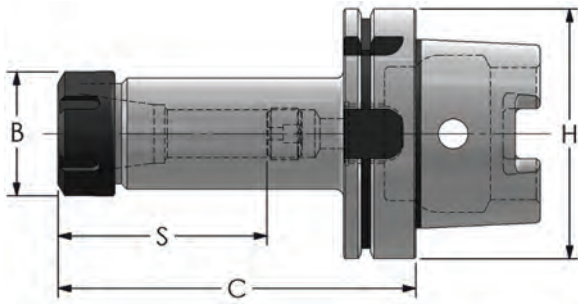

Balanced to:
G2.5 (15,000 rpm)
G6.3 (12,000 rpm)

HSK80A ER Collet Chucks

Designation	B Nut Dia.	C Proj.	S Max Depth	H	Collet Nut	Stop Screw	Wrench	G2 Price*	G6 Price*
HSK80A-ER16-400-G2/G6	1.100	4.00	2.40	3.15	ER-16N	ER-16S	ER-16W	\$369.00	\$345.00
HSK80A-ER32-400-G2/G6	1.980	4.00	2.05	3.15	ER-32N	ER-32S	ER-32W	\$382.00	\$357.00

HSK100A ER Collet Chucks

Designation	B Nut Dia.	C Proj.	S Max Depth	H	Collet Nut	Stop Screw	Wrench	G2 Price*	G6 Price*
HSK100A-ER16-400-G2/G6	1.100	4.00	3.00	3.93	ER-16HN	ER-16S	ER-16W	\$320.00	\$295.00
HSK100A-ER16-600-G2/G6	1.100	6.00	3.00	3.93	ER-16HN	ER-16S	ER-16W	\$345.00	\$320.00
HSK100A-ER32-400-G2/G6	1.980	4.00	4.30	3.93	ER-32SN	ER-32S	ER-32W	\$339.00	\$314.00
HSK100A-ER32-600-G2/G6	1.980	6.00	4.30	3.93	ER-32SN	ER-32S	ER-32W	\$363.00	\$339.00
HSK100A-ER40-400-G2/G6	2.250	4.00	4.00	3.93	ER-40SN	ER-40S	ER-40W	\$345.00	\$320.00
HSK100A-ER40-600-G2/G6	2.250	6.00	4.50	3.93	ER-40SN	ER-40S	ER-40W	\$369.00	\$345.00

HSK125A ER Collet Chucks

Designation	B Nut Dia.	C Proj.	S Max Depth	H	Collet Nut	Stop Screw	Wrench	G2 Price*	G6 Price*
HSK125A-ER16-500-G6	1.100	5.00	3.10	4.92	ER-16HN	ER-16S	ER-16W	--	\$599.00
HSK125A-ER40-500-G6	2.250	5.00	2.80	4.92	ER-40SN	ER-40S	ER-40W	--	\$612.00

* Add -G6 or -G2 to end of designation depending on the balance needed.
All Hardware Included. Wrenches Sold Separately.



- **DIN 69893 Specification**
- **Harnesses Centrifugal Forces to Increase Joint Strength**
- **Highest Static and Dynamic Rigidity**
- **Lowest Load for the Spindle Bearing**
- **Lowest Tool Runout**
- **Hardened and Tempered to Prevent Cracking**
- **Through Spindle Coolant Capability**

M

TOOL HOLDING

HSK100A End Mill Holders

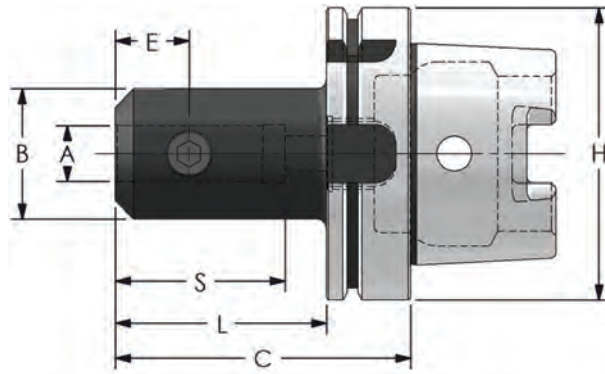

HSK100A End Mill Holders

Balanced to:
G2.5 (15,000 rpm)
G6.3 (12,000 rpm)

Designation	A Inside Dia.	B Outside Dia.	C Proj.	S Max Depth	E	H	L	Set Screw	G2 Price*	G6 Price*
HSK100A-EM250-400-G2/G6	.250	.880	4.00	--	.44	3.94	2.86	SS1/4-250	\$271.00	\$246.00
HSK100A-EM250-600-G2/G6	.250	.880	6.00	--	.44	3.94	4.86	SS1/4-250	\$320.00	\$295.00
HSK100A-EM375-400-G2/G6	.375	1.000	4.00	--	.75	3.94	2.86	SS3/8-375	\$271.00	\$246.00
HSK100A-EM375-600-G2/G6	.375	1.000	6.00	--	.75	3.94	4.86	SS3/8-375	\$320.00	\$295.00
HSK100A-EM500-400-G2/G6	.500	1.375	4.00	--	.88	3.94	2.86	SS7/16-500	\$271.00	\$246.00
HSK100A-EM500-600-G2/G6	.500	1.375	6.00	--	.88	3.94	4.86	SS7/16-500	\$320.00	\$295.00
HSK100A-EM625-400-G2/G6	.625	1.750	4.00	2.10	.94	3.94	2.86	SS9/16-500	\$271.00	\$246.00
HSK100A-EM625-600-G2/G6	.625	1.750	6.00	2.10	.94	3.94	4.86	SS9/16-500	\$320.00	\$295.00
HSK100A-EM750-400-G2/G6	.750	1.750	4.00	2.50	1.00	3.94	2.86	SS5/8-500	\$271.00	\$246.00
HSK100A-EM750-600-G2/G6	.750	1.750	6.00	2.50	1.00	3.94	4.86	SS5/8-500	\$320.00	\$295.00
HSK100A-EM100-400-G2/G6	1.000	2.250	4.00	2.83	1.12	3.94	2.86	SS3/4-500	\$271.00	\$246.00
HSK100A-EM100-600-G2/G6	1.000	2.250	6.00	2.83	1.12	3.94	4.86	SS3/4-500	\$320.00	\$295.00
HSK100A-EM125-425-G2/G6	1.250	2.250	4.25	3.00	1.12	3.94	3.11	(2) SS3/4-500	\$295.00	\$271.00
HSK100A-EM125-600-G2/G6	1.250	2.250	6.00	3.00	1.12	3.94	4.86	(2) SS3/4-500	\$369.00	\$345.00
HSK100A-EM150-450-G2/G6	1.500	2.750	4.50	2.75	1.12	3.94	3.36	(2)SS3/4-500	\$320.00	\$295.00
HSK100A-EM200-550-G2/G6	2.000	3.750	5.50	3.50	1.41	3.94	4.36	(2)SS1-750	\$345.00	\$320.00

* Add -G6 or -G2 to end of designation depending on the balance needed.
All Hardware Included

- **DIN 69893 Specification**
- **Harnesses Centrifugal Forces to Increase Joint Strength**
- **Highest Static and Dynamic Rigidity**
- **Lowest Load for the Spindle Bearing**
- **Lowest Tool Runout**
- **Hardened and Tempered to Prevent Cracking**
- **Through Spindle Coolant Capability**

TOOL HOLDING



Hardware
pg: 186



Collets
pg: 163



HSK100A Shell Mill Holders / BLANKS

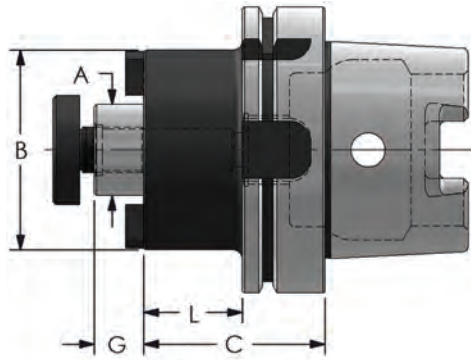

HSK100A Shell Mill Holders

Balanced to:
G6.3 (12,000 rpm)

Designation	A Pilot Dia.	B Dia.	C Proj.	G	H	L	Drive Key	Lock Screw	Thread	Price
HSK100A-SM075-200	.750	1.750	2.00	.68	3.94	.86	UDK 312	U5002	3/8-24	\$332.00
HSK100A-SM100-200	1.000	2.190	2.00	.68	3.94	.86	UDK 375	U5003	1/2-20	\$332.00
HSK100A-SM125-250	1.250	2.750	2.50	.68	3.94	1.36	UDK 500	U5004	5/8-18	\$345.00
HSK100A-SM150-250	1.500	3.380	2.50	.94	3.94	1.36	UDK 625	U5005	3/4-16	\$345.00
HSK100A-SM200-300	2.000	4.440	3.00	.94	3.94	1.86	UDK 750	U5006	1-14	\$382.00

All Hardware Included

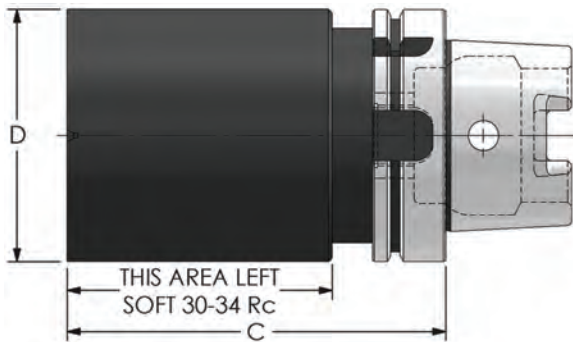

HSK Style Blanks

Designation	Taper	D		C		Price
		mm	Inch	mm	Inch	
HSK80A-BB80-250	HSK80A	80	3.150	250	9.84	\$326.00
HSK80A-BB150-200	HSK80A	150	5.910	200	7.87	\$414.00
HSK100A-BB100-150	HSK100A	100	3.940	150	5.91	\$313.00
HSK100A-BB100-250	HSK100A	100	3.940	250	9.84	\$376.00
HSK100A-BB150-250	HSK100A	150	5.910	250	9.84	\$489.00
HSK125A-BB125-305	HSK125A	125	4.920	305	12.01	\$602.00
HSK125A-BB150-200	HSK125A	150	5.910	200	7.87	\$627.00

M

TOOL HOLDING

HSK100A Shrink-Fit Holders (English)

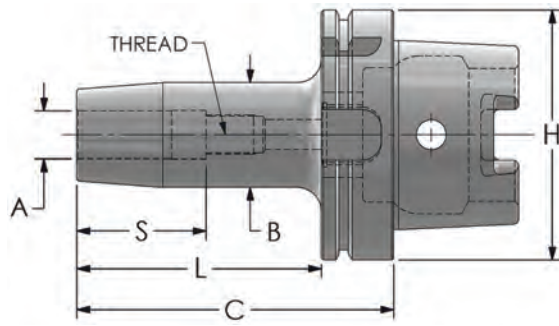

Shrink-Fit
Machines Available
Call for Pricing

HSK100A Shrink-Fit Holders (Std. Length)

Balanced to:
G2.5 (15,000 rpm)

Designation	A Inside Dia.	B Outside Dia.	C Proj.	S	L	H	Thread	Price
HSK100A-SF012-400-G2	.125	1.060	4.00	.79	2.86	3.93	--	\$406.00
HSK100A-SF188-400-G2	.188	1.060	4.00	.79	2.86	3.93	--	\$406.00
HSK100A-SF250-400-G2	.250	1.060	4.00	1.42	2.86	3.93	10-32	\$406.00
HSK100A-SF375-400-G2	.375	1.260	4.00	1.53	2.86	3.93	1/4-28	\$406.00
HSK100A-SF500-400-G2	.500	1.340	4.00	1.85	2.86	3.93	7/16-20	\$406.00
HSK100A-SF625-400-G2	.625	1.340	4.00	1.97	2.86	3.93	9/16-18	\$406.00
HSK100A-SF750-500-G2	.750	1.650	5.00	2.04	3.86	3.93	5/8-18	\$419.00
HSK100A-SF100-500-G2	1.000	2.090	5.00	2.28	3.86	3.93	3/4-16	\$419.00
HSK100A-SF125-500-G2	1.250	2.090	5.00	2.28	3.86	3.93	3/4-16	\$419.00

HSK100A Shrink-Fit Holders (Ext. Length)

Designation	A Inside Dia.	B Outside Dia.	C Proj.	S	L	H	Thread	Price
HSK100A-SF375-600-G2	.375	1.260	6.00	1.53	4.86	3.93	1/4-28	\$431.00
HSK100A-SF500-600-G2	.500	1.340	6.00	1.85	4.86	3.93	7/16-20	\$431.00
HSK100A-SF750-700-G2	.750	1.650	7.00	2.04	5.86	3.93	5/8-18	\$444.00
HSK100A-SF100-700-G2	1.000	2.090	7.00	2.28	5.86	3.93	3/4-16	\$444.00
HSK100A-SF125-700-G2	1.250	2.090	7.00	2.28	5.86	3.93	3/4-16	\$444.00

- BEST Possible T.I.R.
- BEST Available Gripping Power
- BEST Possible Balance
- Fastest Tool Change - In Seconds!
- Ability to Preset for Required Tool Length
- Increased Tool and Spindle Life



E

TOOL HOLDING



Hardware
pg: 186

ULTRA-DEX

Proudly Made in Flushing, MI USA 155

HSK100A Shrink-Fit Holders (Metric)

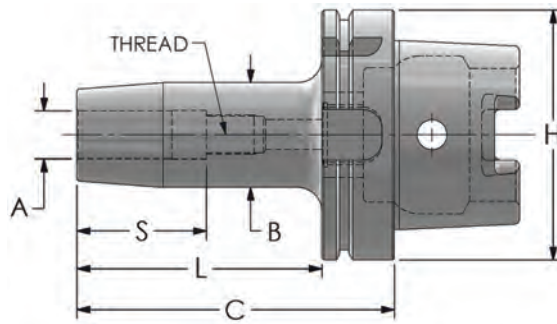

METRIC HSK100A Shrink-Fit Holders (Std. Length)

Balanced to:
G2.5 (15,000 rpm)

Designation	A Inside Dia.	B Outside Dia.	C Proj.	S	L	H	Thread	Price
HSK100A-SF06-400-G2	6mm	1.063	4.00	2.167	2.98	3.934	10-32	\$406.00
HSK100A-SF08-400-G2	8mm	1.063	4.00	1.970	2.98	3.934	1/4-28	\$406.00
HSK100A-SF10-400-G2	10mm	1.260	4.00	2.207	2.98	3.934	1/4-28	\$406.00
HSK100A-SF12-400-G2	12mm	1.260	4.00	2.404	2.98	3.934	7/16-20	\$406.00
HSK100A-SF16-400-G2	16mm	1.339	4.00	2.522	2.98	3.934	9/16-18	\$406.00
HSK100A-SF20-500-G2	20mm	1.654	5.00	2.600	3.98	3.934	5/8-18	\$419.00
HSK100A-SF25-500-G2	25mm	2.087	5.00	2.912	3.98	3.934	3/4-16	\$419.00
HSK100A-SF32-500-G2	32mm	2.087	5.00	2.912	3.98	3.934	3/4-16	\$419.00

HSK100A Shrink-Fit Holders (Ext. Length)

Designation	A Inside Dia.	B Outside Dia.	C Proj.	S	L	H	Thread	Price
HSK100A-SF06-600-G2	6mm	1.063	6.00	2.167	4.98	3.934	10-32	\$431.00
HSK100A-SF08-600-G2	8mm	1.063	6.00	1.970	4.98	3.934	1/4-28	\$431.00
HSK100A-SF10-600-G2	10mm	1.260	6.00	2.207	4.98	3.934	1/4-28	\$431.00
HSK100A-SF12-600-G2	12mm	1.260	6.00	2.404	4.98	3.934	7/16-20	\$431.00
HSK100A-SF16-600-G2	16mm	1.260	6.00	2.522	4.98	3.934	9/16-18	\$431.00
HSK100A-SF20-700-G2	20mm	1.654	7.00	2.600	5.98	3.934	5/8-18	\$444.00
HSK100A-SF25-700-G2	25mm	2.087	7.00	2.912	5.98	3.934	3/4-16	\$444.00
HSK100A-SF32-700-G2	32mm	2.087	7.00	2.912	5.98	3.934	3/4-16	\$444.00



Shrink-Fit
Machines Available
Call for Pricing

EM

TOOL HOLDING

HSK Coolant Tubes / Sockets

HSK Coolant Tubes

Designation	Description	Price
HSK40A-CT	HSK40A Coolant Tube	\$39.00
HSK50A-CT	HSK50A Coolant Tube	\$43.00
HSK63A-CT	HSK63A Coolant Tube	\$23.00
HSK80A-CT	HSK80A Coolant Tube	\$44.00
HSK100A-CT	HSK100A Coolant Tube	\$31.00
HSK125A-CT	HSK125A Coolant Tube	\$48.00



HSK Coolant Tube Sockets

Designation	Description	Price
HSK40A-S	HSK40A Coolant Tube Socket (3/8" Drive)	\$60.00
HSK50A-S	HSK50A Coolant Tube Socket (3/8" Drive)	\$61.00
HSK63A-S	HSK63A Coolant Tube Socket (3/8" Drive)	\$34.00
HSK80A-S	HSK80A Coolant Tube Socket (3/8" Drive)	\$73.00
HSK100A-S	HSK100A Coolant Tube Socket (1/2" Drive)	\$41.00
HSK125A-S	HSK125A Coolant Tube Socket (1/2" Drive)	\$41.00





WE DO SPECIALS!
CAT40/50/60, BT, HSK...
ANY type ANY size

CALL FOR PRICING
810-638-5388



Hardware
pg: 186

ULTRA-DEX

Proudly Made in Flushing, MI USA **157**

E

TOOL HOLDING

Shrink-Fit Extensions

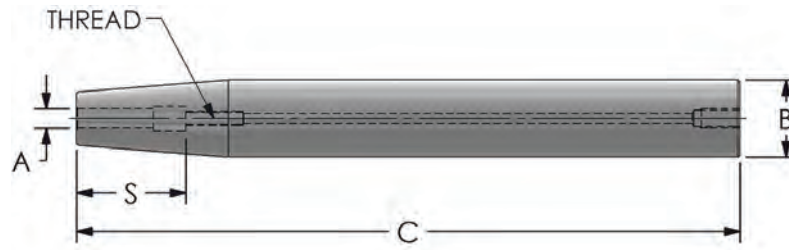

Shrink-Fit Extensions

Designation	A	B	C	S	Thread	Price
SS050-SF012-463	.125	.500	4.63	.79	--	\$136.00
SS075-SF012-463	.125	.750	4.63	.79	--	\$142.00
SS075-SF012-663	.125	.750	6.63	.79	--	\$153.00
SS100-SF012-863	.125	1.000	8.63	.79	--	\$174.47
SS050-SF188-463	.188	.500	4.63	.79	--	\$125.00
SS075-SF188-463	.188	.750	4.63	.79	--	\$131.00
SS075-SF188-663	.188	.750	6.63	.79	--	\$142.00
SS100-SF188-863	.188	1.000	8.63	.79	--	\$164.00
SS075-SF250-463	.250	.750	4.63	1.42	10-32	\$131.00
SS075-SF250-663	.250	.750	6.63	1.42	10-32	\$142.00
SS100-SF250-863	.250	1.000	8.63	1.42	10-32	\$164.00
SS075-SF375-463	.375	.750	4.63	1.53	1/4-28	\$131.00
SS100-SF375-663	.375	1.000	6.63	1.53	1/4-28	\$142.00
SS125-SF375-900	.375	1.250	9.00	1.53	1/4-28	\$196.00
SS100-SF500-463	.500	1.000	4.63	1.85	7/16-20	\$147.00
SS100-SF500-663	.500	1.000	6.63	1.85	7/16-20	\$158.00
SS125-SF500-900	.500	1.250	9.00	1.85	7/16-20	\$196.00
SS100-SF625-463	.625	1.000	4.63	1.97	9/16-18	\$147.00
SS125-SF625-700	.625	1.250	7.00	1.97	1/4-28	\$174.00
SS125-SF750-500	.750	1.250	5.00	2.04	5/8-18	\$153.00
SS125-SF750-700	.750	1.250	7.00	1.42	5/8-18	\$196.00

TOOL HOLDING



Shrink-Fit
Machines Available
Call for Pricing

Tool Bushings

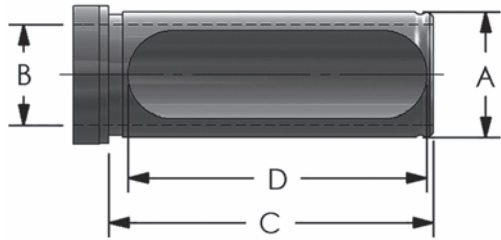

“C” Style Tool Bushings

Designation	A Dia.	B Bore Size	C Length Under Head	D Length of Slot	Price
UT-12C-037	1.250	.375	3.250	2.75	\$79.00
UT-12C-050	1.250	.500	3.250	2.75	\$79.00
UT-12C-062	1.250	.625	3.250	2.75	\$79.00
UT-12C-075	1.250	.750	3.250	2.75	\$79.00
UT-12C-100	1.250	1.000	3.250	2.75	\$79.00
UT-13C-037	1.500	.375	3.375	3.00	\$90.00
UT-13C-050	1.500	.500	3.375	3.00	\$90.00
UT-13C-062	1.500	.625	3.375	3.00	\$90.00
UT-13C-075	1.500	.750	3.375	3.00	\$90.00
UT-13C-100	1.500	1.000	3.375	3.00	\$90.00
UT-13C-125	1.500	1.250	3.375	3.00	\$90.00

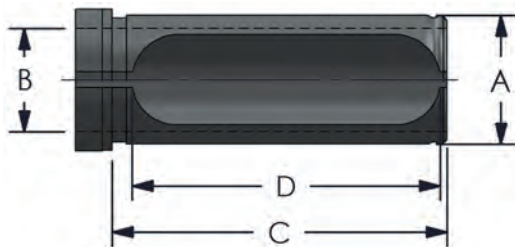

“CX” Style Tool Bushings

Designation	A Dia.	B Bore Size	C Length Under Head	D Length of Slot	Price
UT-12CX-037	1.250	.375	3.250	2.75	\$102.00
UT-12CX-050	1.250	.500	3.250	2.75	\$102.00
UT-12CX-062	1.250	.625	3.250	2.75	\$102.00
UT-12CX-075	1.250	.750	3.250	2.75	\$102.00
UT-12CX-100	1.250	1.000	3.250	2.75	\$102.00
UT-13CX-037	1.500	.375	3.375	3.00	\$125.00
UT-13CX-050	1.500	.500	3.375	3.00	\$125.00
UT-13CX-062	1.500	.625	3.375	3.00	\$125.00
UT-13CX-075	1.500	.750	3.375	3.00	\$125.00
UT-13CX-100	1.500	1.000	3.375	3.00	\$125.00
UT-13CX-125	1.500	1.250	3.375	3.00	\$125.00

E

TOOL HOLDING



Hardware
pg: 186

Metric Tool Bushings

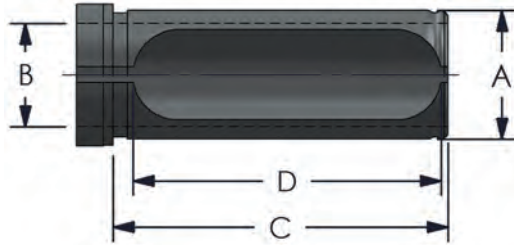

METRIC Tool Bushings

Designation	A Dia.	B Bore Size	C Length Under Head	D Length of Slot	Price
UT-73CX-10MM	1.500	10mm	3.375	3.00	\$139.00
UT-73CX-12MM	1.500	12mm	3.375	3.00	\$139.00
UT-73CX-16MM	1.500	16mm	3.375	3.00	\$139.00
UT-73CX-20MM	1.500	20mm	3.375	3.00	\$139.00
UT-73CX-25MM	1.500	25mm	3.375	3.00	\$139.00
UT-93CX-10MM	40mm	10mm	3.375	3.00	\$160.00
UT-93CX-12MM	40mm	12mm	3.375	3.00	\$160.00
UT-93CX-16MM	40mm	16mm	3.375	3.00	\$160.00
UT-93CX-20MM	40mm	20mm	3.375	3.00	\$160.00
UT-93CX-25MM	40mm	25mm	3.375	3.00	\$160.00



TOOL HOLDING

Straight Shank Collet Chucks (Steel)

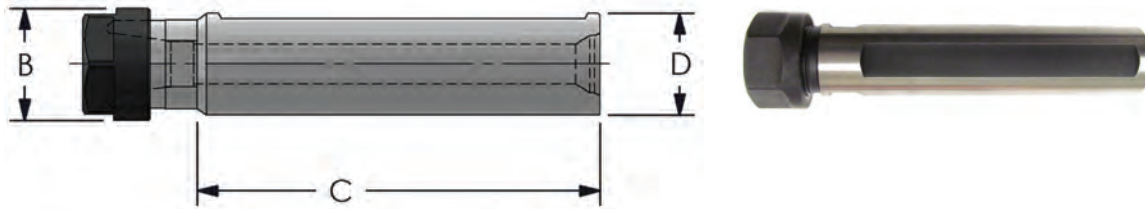

Straight Shank Collet Chucks (English)

Coolant Thru

Designation	Series	Range	B Dia.	C OAL	D Dia.	Collet Nut	Screw	Collet Wrench	Price
SS075-ER16-250	ER16	.020" - .406" (.5mm - 10mm) 1/32" - 13/32"	1.100	2.5	.750	ER-16HN	ER-16S	ER-16W	\$75.00
SS075-ER16-400	ER16		1.100	4	.750	ER-16HN	ER-16S	ER-16W	\$82.00
SS100-ER16-250	ER16		1.100	2.5	1.000	ER-16HN	ER-16S	ER-16W	\$75.00
SS100-ER16-400	ER16		1.100	4	1.000	ER-16HN	ER-16S	ER-16W	\$82.00
SS100-ER16-600	ER16		1.100	6	1.000	ER-16HN	ER-16S	ER-16W	\$88.00
SS075-ER20-250	ER20	.020" - .500" (.5mm - 13mm) 1/32" - 1/2"	1.340	2.5	.750	ER-20HN	ER-20S	ER-20W	\$75.00
SS075-ER20-400	ER20		1.340	4	.750	ER-20HN	ER-20S	ER-20W	\$82.00
SS100-ER20-250	ER20		1.340	2.5	1.000	ER-20HN	ER-20S	ER-20W	\$75.00
SS100-ER20-400	ER20		1.340	4	1.000	ER-20HN	ER-20S	ER-20W	\$82.00
SS100-ER20-600	ER20		1.340	6	1.000	ER-20HN	ER-20S	ER-20W	\$88.00

Straight Shank Collet Chucks (Metric)

Coolant Thru

Designation	Series	Range	B Dia.	C OAL	D Dia.	Collet Nut	Screw	Collet Wrench	Price
SS22MM-ER16-250	ER16	.020" - .406" (.5mm - 10mm) 1/32" - 13/32"	1.100	2.5	22mm	ER-16HN	ER-16S	ER-16W	\$88.00
SS22MM-ER20-250	ER20	.020" - .500" (.5mm - 13mm) 1/32" - 1/2"	1.340	2.5	22mm	ER-20HN	ER-20S	ER-20W	\$88.00

All Hardware Included. Wrenches Sold Separately.

- Adjustable Stop Screw Allows Drills to be Pre-Set
- Balanced for Less Vibration & Longer Tool Life
- T.I.R. .0002
- Hardened & Tempered to Prevent Cracking
- Balanced Nuts (G2.5 at 15,000 RPM)
- Special Lengths Available



Hardware
pg: 186

ULTRA-DEX

Proudly Made in Flushing, MI USA 161

E

TOOL HOLDING

Straight Shank Collet Chucks (Carbide)

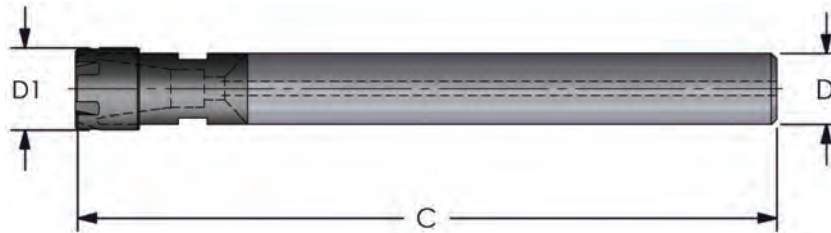

Straight Shank Collet Chucks (w/ Flat)

Coolant Thru

Designation	Series	Range	Collet Nut	C OAL	D Dia.	D1 Dia.	Price
ST1/2 X 8.000 ER11 C W	ER11	.062 -.250	ER11-MN	8	.500	.625	\$296.00
ST5/8 X 7.000 ER11 C W	ER11	(1.5mm - 6.4mm)	ER11-MN	7	.625	.625	\$355.00
ST5/8 X 10.000 ER11 C W	ER11	1/16" - 1/4"	ER11-MN	10	.625	.625	\$416.00
ST5/8 X 7.000 ER16 C W	ER16	.062 -.406 (1.5mm - 10.3mm) 1/16" - 13/32"	ER16-MN	7	.625	.875	\$355.00
ST5/8 X 10.000 ER16 C W	ER16		ER16-MN	10	.625	.875	\$416.00
ST3/4 X 7.000 ER16 C W	ER16		ER16-MN	7	.750	.875	\$440.00
ST3/4 X 10.000 ER16 C W	ER16		ER16-MN	10	.750	.875	\$475.00
ST1 X 8.000 ER16 C W	ER16		ER16-MN	8	1.000	.875	\$636.00
ST1 X 12.000 ER16 C W	ER16		ER16-MN	12	1.000	.875	\$796.00
ST5/8 X 7.000 ER20 C W	ER20		.094 -.500 (2.4mm - 13mm) 3/32" - 1/2"	ER20-MN	7	.625	1.125
ST5/8 X 10.000 ER20 C W	ER20	ER20-MN		10	.625	1.125	\$416.00
ST3/4 X 7.000 ER20 C W	ER20	ER20-MN		7	.750	1.125	\$440.00
ST3/4 X 10.000 ER20 C W	ER20	ER20-MN		10	.750	1.125	\$475.00
ST1 X 8.000 ER20 C W	ER20	ER20-MN		8	1.000	1.125	\$636.00
ST1 X 12.000 ER20 C W	ER20	ER20-MN		12	1.000	1.125	\$796.00

Straight Shank Collet Chucks (w/o Flat)

Coolant Thru

Designation	Series	Range	Collet Nut	C OAL	D Dia.	D1 Dia.	Price
ST1/2 X 5.000 ER11 C	ER11	.062 -.250 (1.5mm - 6.4mm) 1/16" - 1/4"	ER11-MN	5	.500	.625	\$296.00
ST1/2 X 8.000 ER11 C	ER11		ER11-MN	8	.500	.625	\$296.00
ST5/8 X 7.000 ER11 C	ER11		ER11-MN	7	.625	.625	\$355.00
ST5/8 X 10.000 ER11 C	ER11	ER11-MN	10	.625	.625	\$416.00	
ST5/8 X 7.000 ER16 C	ER16	.062 -.406 (1.5mm - 10.3mm) 1/16" - 13/32"	ER16-MN	7	.625	.875	\$355.00
ST5/8 X 10.000 ER16 C	ER16		ER16-MN	10	.625	.875	\$416.00
ST3/4 X 7.000 ER16 C	ER16		ER16-MN	7	.750	.875	\$440.00
ST3/4 X 10.000 ER16 C	ER16		ER16-MN	10	.750	.875	\$475.00
ST1 X 8.000 ER16 C	ER16		ER16-MN	8	1.000	.875	\$636.00
ST1 X 12.000 ER16 C	ER16		ER16-MN	12	1.000	.875	\$796.00
ST5/8 X 7.000 ER20 C	ER20		.094 -.500 (2.4mm - 13mm) 3/32" - 1/2"	ER20-MN	7	.625	1.125
ST5/8 X 10.000 ER20 C	ER20	ER20-MN		10	.625	1.125	\$416.00
ST3/4 X 7.000 ER20 C	ER20	ER20-MN		7	.750	1.125	\$440.00
ST3/4 X 10.000 ER20 C	ER20	ER20-MN		10	.750	1.125	\$475.00
ST1 X 8.000 ER20 C	ER20	ER20-MN		8	1.000	1.125	\$636.00
ST1 X 12.000 ER20 C	ER20	ER20-MN		12	1.000	1.125	\$796.00

All Hardware Included. Wrenches Sold Separately.

TOOL HOLDING

ER Collets / SETS

STANDARD (INCH) ER COLLETS

Standard .0002 T.I.R

	ER11	ER16	ER20	ER25	ER32	ER40
1/16"	ER11C-0625* \$17.00	ER16C-0625 \$15.00	-	-	-	-
3/32"	ER11C-0937* \$17.00	ER16C-0937* \$15.00	ER20C-0937 \$15.00	-	ER32C-0937 \$16.00	-
1/8"	ER11C-1250* \$17.00	ER16C-1250* \$15.00	ER20C-1250* \$15.00	ER25C-1250 \$16.00	ER32C-1250* \$16.00	ER40C-1250* \$19.00
5/32"	ER11C-1562* \$17.00	ER16C-1562* \$15.00	ER20C-1562* \$15.00	ER25C-1562* \$16.00	ER32C-1562 \$16.00	ER40C-1562 \$19.00
3/16"	ER11C-1875* \$17.00	ER16C-1875* \$15.00	ER20C-1875* \$15.00	ER25C-1875* \$16.00	ER32C-1875* \$16.00	ER40C-1875* \$19.00
7/32"	ER11C-2187* \$17.00	ER16C-2187* \$15.00	ER20C-2187* \$15.00	ER25C-2187* \$16.00	ER32C-2187 \$16.00	ER40C-2187 \$19.00
1/4"	ER11C-2500* \$17.00	ER16C-2500* \$15.00	ER20C-2500* \$15.00	ER25C-2500* \$16.00	ER32C-2500* \$16.00	ER40C-2500* \$19.00
9/32"	-	ER16C-2812* \$15.00	ER20C-2812* \$15.00	ER25C-2812 \$16.00	ER32C-2812 \$16.00	ER40C-2812 \$19.00
5/16"	-	ER16C-3125* \$15.00	ER20C-3125* \$15.00	ER25C-3125* \$16.00	ER32C-3125* \$16.00	ER40C-3125* \$19.00
11/32"	-	ER16C-3437* \$15.00	ER20C-3437 \$15.00	ER25C-3437 \$16.00	ER32C-3437 \$16.00	ER40C-3437 \$19.00
3/8"	-	ER16C-3750* \$15.00	ER20C-3750* \$15.00	ER25C-3750* \$16.00	ER32C-3750* \$16.00	ER40C-3750* \$19.00
13/32"	-	ER16C-4062 \$15.00	ER20C-4062 \$15.00	ER25C-4062 \$16.00	ER32C-4062 \$16.00	ER40C-4062 \$19.00
7/16"	-	-	ER20C-4375* \$15.00	ER25C-4375* \$16.00	ER32C-4375* \$16.00	ER40C-4375 \$19.00
15/32"	-	-	ER20C-4687 \$15.00	ER25C-4687 \$16.00	ER32C-4687 \$16.00	ER40C-4687 \$19.00
1/2"	-	-	ER20C-5000* \$15.00	ER25C-5000* \$16.00	ER32C-5000* \$16.00	ER40C-5000* \$19.00
17/32"	-	-	-	ER25C-5312 \$16.00	ER32C-5312 \$16.00	ER40C-5312 \$19.00
9/16"	-	-	-	ER25C-5625* \$16.00	ER32C-5625* \$16.00	ER40C-5625 \$19.00
19/32"	-	-	-	ER25C-5937 \$16.00	ER32C-5937 \$16.00	ER40C-5937 \$19.00
5/8"	-	-	-	ER25C-6250* \$16.00	ER32C-6250* \$16.00	ER40C-6250* \$19.00
21/32"	-	-	-	-	ER32C-6562 \$16.00	ER40C-6562 \$19.00
11/16"	-	-	-	-	ER32C-6875 \$16.00	ER40C-6875 \$19.00
23/32"	-	-	-	-	ER32C-7187 \$16.00	ER40C-7187 \$19.00
3/4"	-	-	-	-	ER32C-7500* \$16.00	ER40C-7500* \$19.00
13/16"	-	-	-	-	-	ER40C-8125 \$19.00
7/8"	-	-	-	-	-	ER40C-8750* \$19.00
1"	-	-	-	-	-	ER40C-1000* \$19.00

Designation	Description	Price
ER11CS	7 pcs (items with "*" in ER11 section included)	\$111.00
ER16CS	10 pcs (items with "*" in ER16 section included)	\$140.00
ER20CS	10 pcs (items with "*" in ER20 section included)	\$140.00
ER25CS	10 pcs (items with "*" in ER25 section included)	\$152.00
ER32CS	10 pcs (items with "*" in ER32 section included)	\$152.00
ER40CS	10 pcs (items with "*" in ER40 section included)	\$164.00

These collets are currently manufactured by our partners in the tooling industry and not by Ultra-Dex at this time.

Proudly Made in Flushing, MI USA 163

ER

TOOL HOLDING

ER Collets / SETS

STANDARD (METRIC) ER COLLETS Standard .0002 T.I.R

	ER11	ER16	ER20	ER25	ER32	ER40
1mm	ER11C-1MM* \$17.00	ER16C-1MM* \$15.00	ER20C-1MM \$16.00	-	-	-
2mm	ER11C-2MM* \$17.00	ER16C-2MM* \$15.00	ER20C-2MM* \$16.00	ER25C-2MM* \$14.21	-	-
3mm	ER11C-3MM* \$17.00	ER16C-3MM* \$15.00	ER20C-3MM* \$16.00	ER25C-3MM* \$16.00	ER32C-3MM* \$16.00	ER40C-3MM* \$19.00
4mm	ER11C-4MM* \$17.00	ER16C-4MM* \$15.00	ER20C-4MM* \$16.00	ER25C-4MM* \$16.00	ER32C-4MM* \$16.00	ER40C-4MM* \$19.00
5mm	ER11C-5MM* \$17.00	ER16C-5MM* \$15.00	ER20C-5MM* \$16.00	ER25C-5MM* \$16.00	ER32C-5MM* \$16.00	ER40C-5MM* \$19.00
6mm	ER11C-6MM* \$17.00	ER16C-6MM* \$15.00	ER20C-6MM* \$16.00	ER25C-6MM* \$16.00	ER32C-6MM* \$16.00	ER40C-6MM* \$19.00
7mm	ER11C-7MM \$17.00	ER16C-7MM \$15.00	ER20C-7MM \$16.00	ER25C-7MM \$16.00	ER32C-7MM \$16.00	ER40C-7MM \$19.00
8mm	-	ER16C-8MM* \$15.00	ER20C-8MM* \$16.00	ER25C-8MM* \$16.00	ER32C-8MM* \$16.00	ER40C-8MM* \$19.00
9mm	-	ER16C-9MM \$15.00	ER20C-9MM \$16.00	ER25C-9MM \$16.00	ER32C-9MM \$16.00	ER40C-9MM \$19.00
10mm	-	ER16C-10MM* \$15.00	ER20C-10MM* \$16.00	ER25C-10MM* \$16.00	ER32C-10MM* \$16.00	ER40C-10MM* \$19.00
11mm	-	-	ER20C-11MM \$16.00	ER25C-11MM \$16.00	ER32C-11MM \$16.00	ER40C-11MM \$19.00
12mm	-	-	ER20C-12MM* \$16.00	ER25C-12MM* \$16.00	ER32C-12MM* \$16.00	ER40C-12MM* \$19.00
13mm	-	-	ER20C-13MM \$16.00	ER25C-13MM \$16.00	ER32C-13MM \$16.00	ER40C-13MM \$19.00
14mm	-	-	ER20C-14MM* \$16.00	ER25C-14MM* \$16.00	ER32C-14MM* \$16.00	ER40C-14MM* \$19.00
15mm	-	-	-	ER25C-15MM \$16.00	ER32C-15MM \$16.00	ER40C-15MM \$19.00
16mm	-	-	-	ER25C-16MM* \$16.00	ER32C-16MM* \$16.00	ER40C-16MM* \$19.00
17mm	-	-	-	ER25C-17MM \$16.00	ER32C-17MM \$16.00	ER40C-17MM \$19.00
18mm	-	-	-	-	ER32C-18MM* \$16.00	ER40C-18MM* \$19.00
19mm	-	-	-	-	ER32C-19MM \$16.00	ER40C-19MM \$19.00
20mm	-	-	-	-	ER32C-20MM* \$16.00	ER40C-20MM* \$19.00
21mm	-	-	-	-	ER32C-21MM \$16.00	ER40C-21MM \$19.00
22mm	-	-	-	-	-	ER40C-22MM* \$19.00
23mm	-	-	-	-	-	ER40C-23MM \$19.00
24mm	-	-	-	-	-	ER40C-24MM* \$19.00
25mm	-	-	-	-	-	ER40C-25MM \$19.00
26mm	-	-	-	-	-	ER40C-26MM* \$19.00

Designation	Description	Price
ER11MCS	6 pcs (items with "*" in ER11 section included)	\$94.00
ER16MCS	8 pcs (items with "*" in ER16 section included)	\$109.00
ER20MCS	9 pcs (items with "*" in ER20 section included)	\$123.00
ER25MCS	10 pcs (items with "*" in ER25 section included)	\$136.00
ER32MCS	11 pcs (items with "*" in ER32 section included)	\$162.00
ER40MCS	14 pcs (items with "*" in ER40 section included)	\$235.00

These collets are currently manufactured by our partners in the tooling industry and not by Ultra-Dex at this time.

ER Collets

Steel Sealed STANDARD (INCH) ER COLLETS

	ER16	ER20	ER25	ER32	ER40
1/8"	ER16C-SS-1250 \$44.00	ER20C-SS-1250 \$49.00	ER25C-SS-1250 \$51.00	ER32C-SS-1250 \$55.00	ER40C-SS-1250 \$61.00
5/32"	ER16C-SS-1562 \$44.00	ER20C-SS-1562 \$49.00	ER25C-SS-1562 \$51.00	ER32C-SS-1562 \$55.00	ER40C-SS-1562 \$61.00
3/16"	ER16C-SS-1875 \$44.00	ER20C-SS-1875 \$49.00	ER25C-SS-1875 \$51.00	ER32C-SS-1875 \$55.00	ER40C-SS-1875 \$61.00
7/32"	ER16C-SS-2187 \$44.00	ER20C-SS-2187 \$49.00	ER25C-SS-2187 \$51.00	ER32C-SS-2187 \$55.00	ER40C-SS-2187 \$61.00
1/4"	ER16C-SS-2500 \$44.00	ER20C-SS-2500 \$49.00	ER25C-SS-2500 \$51.00	ER32C-SS-2500 \$55.00	ER40C-SS-2500 \$61.00
9/32"	ER16C-SS-2812 \$44.00	ER20C-SS-2812 \$49.00	ER25C-SS-2812 \$51.00	ER32C-SS-2812 \$55.00	ER40C-SS-2812 \$61.00
5/16"	ER16C-SS-3125 \$44.00	ER20C-SS-3125 \$49.00	ER25C-SS-3125 \$51.00	ER32C-SS-3125 \$55.00	ER40C-SS-3125 \$61.00
11/32"	ER16C-SS-3437 \$44.00	ER20C-SS-3437 \$49.00	ER25C-SS-3437 \$51.00	ER32C-SS-3437 \$55.00	ER40C-SS-3437 \$31.00
3/8"	ER16C-SS-3750 \$44.00	ER20C-SS-3750 \$49.00	ER25C-SS-3750 \$51.00	ER32C-SS-3750 \$55.00	ER40C-SS-3750 \$31.00
13/32"	ER16C-SS-4062 \$44.00	ER20C-SS-4062 \$49.00	ER25C-SS-4062 \$51.00	ER32C-SS-4062 \$55.00	ER40C-SS-4062 \$61.00
7/16"	-	ER20C-SS-4375 \$49.00	ER25C-SS-4375 \$51.00	ER32C-SS-4375 \$55.00	ER40C-SS-4375 \$61.00
15/32"	-	ER20C-SS-4687 \$49.00	ER25C-SS-4687 \$51.00	ER32C-SS-4687 \$55.00	ER40C-SS-4687 \$61.00
1/2"	-	ER20C-SS-5000 \$49.00	ER25C-SS-5000 \$51.00	ER32C-SS-5000 \$55.00	ER40C-SS-5000 \$61.00
17/32"	-	-	ER25C-SS-5312 \$51.00	ER32C-SS-5312 \$55.00	ER40C-SS-5312 \$61.00
9/16"	-	-	ER25C-SS-5625 \$51.00	ER32C-SS-5625 \$55.00	ER40C-SS-5625 \$61.00
19/32"	-	-	ER25C-SS-5937 \$51.00	ER32C-SS-5937 \$55.00	ER40C-SS-5937 \$61.00
5/8"	-	-	ER25C-SS-6250 \$51.00	ER32C-SS-6250 \$55.00	ER40C-SS-6250 \$61.00
21/32"	-	-	-	ER32C-SS-6562 \$55.00	ER40C-SS-6562 \$61.00
11/16"	-	-	-	ER32C-SS-6875 \$55.00	ER40C-SS-6875 \$61.00
23/32"	-	-	-	ER32C-SS-7187 \$55.00	ER40C-SS-7187 \$61.00
3/4"	-	-	-	ER32C-SS-7500 \$55.00	ER40C-SS-7500 \$61.00
13/16"	-	-	-	-	ER40C-SS-8125 \$61.00
7/8"	-	-	-	-	ER40C-SS-8750 \$61.00
1"	-	-	-	-	ER40C-SS-1000 \$61.00

These collets are currently manufactured by our partners in the tooling industry and not by Ultra-Dex at this time.



Hardware
pg: 186

Proudly Made in Flushing, MI USA 165

E

TOOL HOLDING

ER Collets

Steel Sealed STANDARD (METRIC) ER COLLETS

	ER16	ER20	ER25	ER32	ER40
4mm	ER16C-SS-4MM \$44.00	ER20C-SS-4MM \$49.00	ER25C-SS-4MM \$51.00	ER32C-SS-4MM \$55.00	-
5mm	ER16C-SS-5MM \$44.00	ER20C-SS-5MM \$49.00	ER25C-SS-5MM \$51.00	ER32C-SS-5MM \$55.00	-
6mm	ER16C-SS-6MM \$44.00	ER20C-SS-6MM \$49.00	ER25C-SS-6MM \$51.00	ER32C-SS-6MM \$55.00	ER40C-SS-6MM \$61.00
7mm	ER16C-SS-7MM \$44.00	ER20C-SS-7MM \$49.00	ER25C-SS-7MM \$51.00	ER32C-SS-7MM \$55.00	ER40C-SS-7MM \$61.00
8mm	ER16C-SS-8MM \$44.00	ER20C-SS-8MM \$49.00	ER25C-SS-8MM \$51.00	ER32C-SS-8MM \$55.00	ER40C-SS-8MM \$61.00
9mm	ER16C-SS-9MM \$44.00	ER20C-SS-9MM \$49.00	ER25C-SS-9MM \$51.00	ER32C-SS-9MM \$55.00	ER40C-SS-9MM \$61.00
10mm	ER16C-SS-10MM \$44.00	ER20C-SS-10MM \$49.00	ER25C-SS-10MM \$51.00	ER32C-SS-10MM \$55.00	ER40C-SS-10MM \$61.00
11mm	-	ER20C-SS-11MM \$49.00	ER25C-SS-11MM \$51.00	ER32C-SS-11MM \$55.00	ER40C-SS-11MM \$61.00
12mm	-	ER20C-SS-12MM \$49.00	ER25C-SS-12MM \$51.00	ER32C-SS-12MM \$55.00	ER40C-SS-12MM \$61.00
13mm	-	ER20C-SS-13MM \$49.00	ER25C-SS-13MM \$51.00	ER32C-SS-13MM \$55.00	ER40C-SS-13MM \$61.00
14mm	-	-	ER25C-SS-14MM \$51.00	ER32C-SS-14MM \$55.00	ER40C-SS-14MM \$61.00
15mm	-	-	ER25C-SS-15MM \$51.00	ER32C-SS-15MM \$55.00	ER40C-SS-15MM \$61.00
16mm	-	-	ER25C-SS-16MM \$51.00	ER32C-SS-16MM \$55.00	ER40C-SS-16MM \$61.00
17mm	-	-	-	ER32C-SS-17MM \$55.00	ER40C-SS-17MM \$61.00
18mm	-	-	-	ER32C-SS-18MM \$55.00	ER40C-SS-18MM \$61.00
19mm	-	-	-	ER32C-SS-19MM \$55.00	ER40C-SS-19MM \$61.00
20mm	-	-	-	ER32C-SS-20MM \$55.00	ER40C-SS-20MM \$61.00
21mm	-	-	-	-	ER40C-SS-21MM \$61.00
22mm	-	-	-	-	ER40C-SS-22MM \$61.00
23mm	-	-	-	-	ER40C-SS-23MM \$61.00
24mm	-	-	-	-	ER40C-SS-24MM \$61.00
25mm	-	-	-	-	ER40C-SS-25MM \$61.00
26mm	-	-	-	-	ER40C-SS-26MM \$61.00

These collets are currently manufactured by our partners in the tooling industry and not by Ultra-Dex at this time.



TOOL HOLDING

Insert NOMENCLATURE / Speed & Feeds

Inscribe Circle Size

INCH	Diameter of Inscribed Circle (Inch)	METRIC						
1.2 (5)	.156		02		04	03	03	06
1.28	.160							07
1.5 (6)	.187		L3	08	05	04	04	08
1.8 (7)	.219		03	09	06	05	05	09
2	.250		04	11	07	06	06	11
2.5	.313		05	13	09	08	07	13
3	.375	09	06	16	11	09	09	16
4	.500	12	08	22	15	12	12	22
5	.625		10		19	16	15	27
6	.750	19	13		23	19	19	33
08	8.00mm	08						
10	10.00mm	10						
12	12.00mm	12						
16	16.00mm	16						

Shape	Tolerance
A Rectangle	Insert IC. Thickness F = ± .002 to ± .004 ± .002
C 80° Diamond	G = ± .001 ± .005
D 55° Diamond	H = ± .005 ± .001
S Square	K = ± .005 ± .001
T Triangle	M = ± .002 to ± .007* ± .005
V 35° Diamond	
W 80° Trigon	
R Round	

*Exact tolerance is determined by the size of the insert

INCH (ANSI)	T	N	M	G
METRIC (ISO)	T	N	M	G

INCH	Corner Radius	METRIC
0	.004	01
0.1	.002	--
0.5	.008	02
1	.015 (1/64)	04
2	.031 (1/32)	08
3	.046 (3/64)	12
4	.062 (1/16)	16

Clearance Angle	Type
B 5° Positive	A With hole, without chipbreaker
C 7° Positive	B Countersink on one side, with hole
D 15° Positive	G Chipbreaker on both sides, with hole
N 0° Negative	T Chipbreaker & ISO countersink one side, with hole
P 11° Positive	W ISO Countersink on one side, with hole
	X Special Design

Thickness		
INCH	Thickness	METRIC
0.6	.040	T0
0.75	.046	--
1	1/16	01
1.2	5/64	T1
1.5	3/32	02
2	1/8	03
2.5	5/32	T3
3	3/16	04
4	1/4	06

Insert Speed & Feed Information

Material	Turning		Milling*		Drilling	
	SFM	Inch/ Rev	SFM	Inch/ Rev	SFM	Inch/ Rev
P Mild Steel Annealed Alloy Steel Hardened Alloy Steel Cast Steel	490-1200		250-800		225-650	
	490-980	.004-.031	200-725	.003-.015	200-650	.0022-.006
	180-500		200-600		100-300	
	180-650		200-600		150-550	
M Stainless Steel	280-810	.004-.015	200-600	.003-.015	250-430	.002-.006
K Low Cast Iron High Cast Iron	590-1240	.004-.024	325-600	.004-.016	300-600	.0025-.009
	360-700		325-600		300-600	
N Alum. Alloy Un-heat Treated Alum. Alloy Heat Treated Cast Alum. & Copper Alloy	850-1980		860-1800		600-1100	
	550-1650	.004-.018	575-1230	.007-.018	315-790	.0038-.011
	360-950		280-930		250-760	
S Heat Resistant Steels	100-300	.002-.006	100-300	.0024-.008	60-150	.0028-.008
K Cast Iron (CBN INSERTS)	400-600	.002-.020				
H Hardened Material (CBN INSERTS)	450-950	.002-.011				

*For APKT inserts refer to the chart on pg 201 for cutting conditions.

MATERIAL	FINISHING	MEDIUM	ROUGHING
P	CX2, LX6, SP1, SP2, SX1, ZX3	CX1, LX3, ZP1	CP2, LX2
M	CM1, CM3, CX2, LX6, ZM1	CM1, CM2, LX3	LX2
K	ZX3	ZK1, ZK2	
S		CS1	
N	SX1, ZN1	CN1, LX2, LX3	



Insert Grade Conditions

HIGH PERFORMANCE GRADES AVAILABLE *

○ Good
◐ Better
● Best

Grade	Description	Material Categories					
		Steel	Stainless Steel	Cast Iron	Ferrite Materials	Heat-Resistant Steel	Hardened Metal
		P	M	K	N	S	H
UD51	General purpose TiN (CVD) coated steel grade - used for roughing and semi-finishing of carbon alloy and stainless steel.	●	○	○		◐	
UD52	Tough general purpose steel grade with multi-layer titanium aluminum nitride coating for alloy steel, aluminum alloys, austenitic stainless and carbon steels, copper alloys and exotic alloys.	●	○			●	
HP230 *	Productive steel turning grade under stable conditions.	●	○	◐			
HP250 *	Universal steel turning grade-The best in efficiency and productivity.	●	○	◐			
UD21	Multi-layer titanium aluminum nitride grade. Excellent for machining cast iron.		◐	●			
HM240 *	Stainless steel turning grade. Finishing to light roughing.	○	●		○		
HM250 *	Turning grade for wide application in the stainless steel range. Finishing to roughing.	◐	●			○	
HS220 *	Excellent for heat resistance and titanium alloys		○			●	
UD2	Uncoated - Used to cut cast iron, aluminum, non-ferrous alloys, non-metals and most high temp alloys. Provides excellent wear resistance.			○	◐		
HN432 *	Ideal grade for aluminum. Low tendency for adhesion.			◐	●		
UD22	TiN coated insert. Suitable for semi-finishing and finishing of high temp alloys. Intended for cast iron machining.			●		◐	
UD32	TiAlN coated insert. Used in high speed medium load applications of stainless steel and finishing to semi-finishing of high temperature alloys.	◐	●	○	○	●	
HK036 *	Stability in a wide range of applications with long tool life. First choice for turning cast iron.			●			
UD5C	Uncoated cermet grade for semi-finishing and finishing applications at medium to high cutting speeds on carbon and alloyed steels. Also used on stainless. Normally used without coolant.		○	○			
UD5CT	TiAlN coated cermet grade performs extremely well for semi-finish and finish applications in alloyed steels, stainless and high carbon steels.	●	◐	◐			
UD1	Uncoated - Designed with a polished surface and large rake angle, Intended for machining aluminum and other non-ferrous alloys. Also works well for semi machining on cast iron.		◐		●		
HP470 *	Suitable for demanding steel milling applications, interrupted cut.	●	◐				
HM470 *	Stainless steel milling grade. PVD, TiAlN coating.	◐	●				
HS470 *	First choice for milling heat-resistant alloys.		○			●	
HS480 *	Extremely heat-resistant tough grade for milling titanium.					●	
HK430 *	Milling grade for cast iron.			●			
HP600 *	Super tough substrate with PVD coating. Excellent for drilling steel and stainless steel.	●	◐	○	○	○	
HK356 *	Stable cutting performance for drilling cast iron. Suitable for aluminum. Recommended for mild structural steel, difficult chip controlled steel.	◐	●	●	◐	◐	
HN300 *	Drilling Grade for Aluminum				●		
UD2CBN	A Polycrystalline Cubic Boron Nitride (PCBN) Insert for cast iron, gray cast iron, chilled cast, and powder metal with long tool life. Coolant not recommended for use.			●			◐
UD5CBN	A Polycrystalline Cubic Boron Nitride (PCBN) Insert for precision finishing of hardened steels 50-65 rockwell. Coolant not recommended for use.			◐			●
UD2PCD	Polycrystalline Diamond with Carbide Reinforced Diamond, Sharpness and Low Cutting Pressure allowing tight tolerances. Finishing of all non-ferrous metals and non-metallics.				●		
UD25	Uncoated - Used to cut aluminum, brass, copper, nickel base alloys, titanium and non-ferrous materials.			○	○		
UD204	A PVD TiAlN coated fine grain substrate. Excellent for light to medium feeds on cast iron and semi-finishing to finishing of high temperature alloys. Excellent for high SFM.	◐		●		◐	
UD404	A PVD TiAlN coated tough general purpose grade. Well suited for milling alloy steels, stainless steel, high temperature alloy steels and hardened steels up to 60 Rc.	●	●	◐		●	
UD602	A CVD coating of TiAl ₂ O ₃ & TiN on a tough substrate. It is suitable for light to heavy milling of alloy steel and non alloy steel, even under unfavorable condition.	◐	◐			◐	

INSERTS

Turning Inserts



ZX3



CDGW Flat Top



CDHB Flat Top

DESIGNATION	GRADE															
	HP230	HP250	HM240	HM250	HS220	HN432	HK036	UD51	UD52	UD21	UD2	UD22	UD32	UD5C	UD5CT	UD1
CDGT 1.510.5-ZX3	-	-	-	-	-	-	-	\$9.20	\$9.60	\$9.60	\$8.00	-	-	\$9.20	\$10.50	-
CDGT 1.511-ZX3	-	-	-	-	-	-	-	\$9.20	\$9.60	\$9.60	\$8.00	-	-	\$9.20	\$10.50	-
CDGW 1.510	-	-	-	-	-	-	-	\$8.70	\$9.60	\$9.10	\$8.70	-	-	\$8.50	\$10.40	-
CDGW 1.510.5	-	-	-	-	-	-	-	\$8.70	\$9.60	\$9.10	\$8.70	-	-	\$8.50	\$10.40	-
CDGW 1.511	-	-	-	-	-	-	-	\$8.70	\$9.60	\$9.10	\$8.70	-	-	\$8.50	\$10.40	-
CDHB 1.20.60	-	-	-	-	-	-	-	\$8.30	\$8.70	\$8.70	\$7.00	-	-	\$7.80	\$9.50	-
CDHB 1.20.60.5	-	-	-	-	-	-	-	\$8.30	\$8.70	\$8.70	\$7.00	-	-	\$7.80	\$9.50	-

Inserts sold in packs of 10

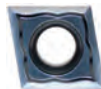

CM1



CN1



CX1



CX2



ZM1

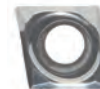

ZN1



ZX3

DESIGNATION	GRADE															
	HP230	HP250	HM240	HM250	HS220	HN432	HK036	UD51	UD52	UD21	UD2	UD22	UD32	UD5C	UD5CT	UD1
CCGT 21.50-CM1	-	-	\$14.00	-	-	-	-	-	-	-	-	-	-	-	-	-
CCGT 32.50.5-CM1	-	-	\$16.00	-	-	-	-	-	-	-	-	-	-	-	-	-
CCGT 32.50-CM1	-	-	\$16.00	-	-	-	-	-	-	-	-	-	-	-	-	-
CCGT 21.50-CN1	-	-	-	-	-	\$10.60	-	-	-	-	-	-	-	-	-	-
CCGT 21.51-CN1	-	-	-	-	-	\$10.60	-	-	-	-	-	-	-	-	-	-
CCGT 32.51-CN1	-	-	-	-	-	\$11.00	-	-	-	-	-	-	-	-	-	-
CCGT 32.52-CN1	-	-	-	-	-	\$11.00	-	-	-	-	-	-	-	-	-	-
CCMT 21.51-CX1	\$7.60	\$7.60	-	\$7.60	-	-	\$7.60	-	-	-	-	-	-	-	-	-
CCMT 21.52-CX1	-	\$7.60	-	\$7.60	-	-	-	-	-	-	-	-	-	-	-	-
CCMT 32.51-CX1	\$8.00	\$8.00	-	\$8.00	-	-	\$8.00	-	-	-	-	-	-	-	-	-
CCMT 32.52-CX1	\$8.00	\$8.00	-	\$8.00	-	-	\$8.00	-	-	-	-	-	-	-	-	-
CCMT 431-CX1	-	\$10.40	-	\$10.40	-	-	\$10.40	-	-	-	-	-	-	-	-	-
CCMT 432-CX1	-	\$10.40	-	\$10.40	-	-	\$10.40	-	-	-	-	-	-	-	-	-
CCMT 32.50.5-CX2	-	\$8.00	-	\$8.00	-	-	-	-	-	-	-	-	-	-	-	-
CCMT 21.51-ZM1	-	-	-	-	-	-	-	-	-	-	-	-	\$6.70	-	-	-
CCMT 32.50.5-ZM1	-	-	-	-	-	-	-	-	-	-	-	-	\$7.10	-	-	-
CCMT 32.51-ZM1	-	-	-	-	-	-	-	-	-	-	-	-	\$7.10	-	-	-
CCMT 32.52-ZM1	-	-	-	-	-	-	-	-	-	-	-	-	\$7.10	-	-	-
CCMT 431-ZM1	-	-	-	-	-	-	-	-	-	-	-	-	\$8.00	-	-	-
CCMT 432-ZM1	-	-	-	-	-	-	-	-	-	-	-	-	\$8.00	-	-	-
CCGX 21.50.5-ZN1	-	-	-	-	-	-	-	-	-	-	-	-	-	-	-	\$7.80
CCGX 21.51-ZN1	-	-	-	-	-	-	-	-	-	-	-	-	-	-	-	\$7.80
CCGX 32.51-ZN1	-	-	-	-	-	-	-	-	-	-	-	-	-	-	-	\$8.10
CCGX 32.52-ZN1	-	-	-	-	-	-	-	-	-	-	-	-	-	-	-	\$8.10
CCMT 21.51-ZX3	-	-	-	-	-	-	-	\$6.70	\$6.70	\$6.70	-	-	-	-	-	-
CCMT 21.52-ZX3	-	-	-	-	-	-	-	\$6.70	\$6.70	\$6.70	-	-	-	-	-	-
CCMT 32.50.5-ZX3	-	-	-	-	-	-	-	\$7.10	\$7.10	\$7.10	-	-	-	-	-	-
CCMT 32.51-ZX3	-	-	-	-	-	-	-	\$7.10	\$7.10	\$7.10	-	-	-	-	-	-
CCMT 32.52-ZX3	-	-	-	-	-	-	-	\$7.10	\$7.10	\$7.10	-	-	-	-	-	-
CCMT 431-ZX3	-	-	-	-	-	-	-	\$8.00	\$8.00	\$8.00	-	-	-	-	-	-
CCMT 432-ZX3	-	-	-	-	-	-	-	\$8.00	\$8.00	\$8.00	-	-	-	-	-	-

Inserts sold in packs of 10



INSERTS

Turning Inserts



LX6

DESIGNATION	GRADE															
	HP230	HP250	HM240	HM250	HS220	HN432	HK036	UD51	UD52	UD21	UD2	UD22	UD32	UD5C	UD5CT	UD1
CPMT 1.81.20.5-LX6	-	-	-	-	-	-	-	\$11.00	\$13.00	\$12.00	\$9.50	-	-	\$9.80	\$12.00	-
CPMT 1.81.21-LX6	-	-	-	-	-	-	-	\$11.00	\$13.00	\$12.00	\$9.50	-	-	\$9.80	\$12.00	-
CPMT 21.50.5-LX6	-	-	-	-	-	-	-	\$8.40	\$10.60	\$9.50	\$7.10	-	-	\$9.80	\$12.00	-
CPMT 21.51-LX6	-	-	-	-	-	-	-	\$8.40	\$10.60	\$9.50	\$7.10	-	-	\$9.80	\$12.00	-
CPMT 21.52-LX6	-	-	-	-	-	-	-	\$8.40	\$10.60	\$10.20	\$7.10	-	-	\$9.80	\$12.00	-
CPMT 32.51-LX6	-	-	-	-	-	-	-	\$8.80	\$10.60	\$10.20	\$7.40	-	-	-	-	-
CPMT 32.52-LX6	-	-	-	-	-	-	-	\$8.80	\$10.60	\$10.20	\$7.40	-	-	-	-	-

Inserts sold in packs of 10



DESIGNATION	GRADE															
	HP230	HP250	HM240	HM250	HS220	HN432	HK036	UD51	UD52	UD21	UD2	UD22	UD32	UD5C	UD5CT	UD1
DCGT 21.50-CM1	-	-	\$15.00	-	-	-	-	-	-	-	-	-	-	-	-	-
DCGT 32.50-CM1	-	-	\$16.00	-	-	-	-	-	-	-	-	-	-	-	-	-
DCGT 21.50-CN1	-	-	-	-	-	\$10.60	-	-	-	-	-	-	-	-	-	-
DCGT 21.51-CN1	-	-	-	-	-	\$10.60	-	-	-	-	-	-	-	-	-	-
DCGT 32.51-CN1	-	-	-	-	-	\$12.00	-	-	-	-	-	-	-	-	-	-
DCGT 32.52-CN1	-	-	-	-	-	\$12.00	-	-	-	-	-	-	-	-	-	-
DCMT 21.51-CX1	-	\$6.70	-	\$6.70	-	-	\$6.70	-	-	-	-	-	-	-	-	-
DCMT 21.52-CX1	-	\$6.70	-	\$6.70	-	-	-	-	-	-	-	-	-	-	-	-
DCMT 32.51-CX1	\$8.40	\$8.40	-	\$8.40	-	-	\$8.40	-	-	-	-	-	-	-	-	-
DCMT 32.52-CX1	\$8.40	\$8.40	-	\$8.40	-	-	\$8.40	-	-	-	-	-	-	-	-	-
DCMT 21.50-CX2	-	\$6.70	-	\$6.70	-	-	-	-	-	-	-	-	-	-	-	-
DCMT 32.50-CX2	-	\$8.40	-	\$8.40	-	-	-	-	-	-	-	-	-	-	-	-
DCMT 21.50.5-LX6	-	-	-	-	-	-	-	\$8.00	\$9.70	\$8.70	-	-	-	-	-	-
DCMT 21.50.5-ZM1	-	-	-	-	-	-	-	-	-	-	-	-	\$6.40	-	-	-
DCMT 21.51-ZM1	-	-	-	-	-	-	-	-	-	-	-	-	\$6.40	-	-	-
DCMT 32.51-ZM1	-	-	-	-	-	-	-	-	-	-	-	-	\$7.80	-	-	-
DCMT 32.52-ZM1	-	-	-	-	-	-	-	-	-	-	-	-	\$7.80	-	-	-
DCGX 21.50.5-ZN1	-	-	-	-	-	-	-	-	-	-	-	-	-	-	-	\$7.50
DCGX 21.51-ZN1	-	-	-	-	-	-	-	-	-	-	-	-	-	-	-	\$7.50
DCGX 32.51-ZN1	-	-	-	-	-	-	-	-	-	-	-	-	-	-	-	\$8.30
DCGX 32.52-ZN1	-	-	-	-	-	-	-	-	-	-	-	-	-	-	-	\$8.30
DCMT 21.51-ZX3	-	-	-	-	-	-	-	\$6.40	\$6.40	\$6.40	-	-	-	-	-	-
DCMT 32.51-ZX3	-	-	-	-	-	-	-	\$7.80	\$7.80	\$7.80	-	-	-	-	-	-
DCMT 32.52-ZX3	-	-	-	-	-	-	-	\$7.80	\$7.80	\$7.80	-	-	-	-	-	-
DPMT 32.51-LX6	-	-	-	-	-	-	-	\$9.80	\$11.00	\$11.00	\$8.10	\$9.90	-	-	-	-
DPMT 32.52-LX6	-	-	-	-	-	-	-	\$9.80	\$11.00	\$11.00	\$8.10	\$9.90	-	-	-	-

Inserts sold in packs of 10

INSERTS

Turning Inserts

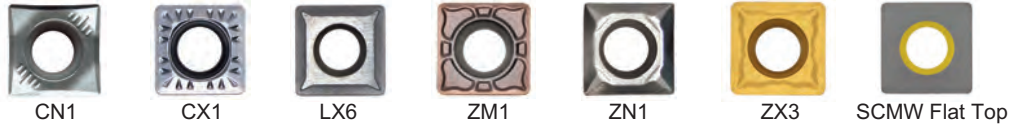

DESIGNATION	GRADE															
	HP 230	HP 250	HM240	HM250	HS220	HN432	HK036	UD51	UD52	UD21	UD2	UD22	UD32	UD5C	UD5CT	UD1
SCGT 32.51-CN1	-	-	-	-	-	\$11.00	-	-	-	-	-	-	-	-	-	-
SCMT 32.51-CX1	-	\$8.00	-	\$8.00	-	-	\$8.00	-	-	-	-	-	-	-	-	-
SCMT 32.52-CX1	-	\$8.00	-	\$8.00	-	-	\$8.00	-	-	-	-	-	-	-	-	-
SCMT 431-CX1	-	\$10.40	-	\$10.40	-	-	-	-	-	-	-	-	-	-	-	-
SCMT 432-CX1	-	\$10.40	-	\$10.40	-	-	\$10.40	-	-	-	-	-	-	-	-	-
SCMT 21.51-LX6	-	-	-	-	-	-	-	\$7.90	\$9.60	\$8.70	-	\$7.60	-	-	-	-
SCMT 32.51-LX6	-	-	-	-	-	-	-	-	-	-	-	\$8.40	-	-	-	-
SCMT 32.52-LX6	-	-	-	-	-	-	-	-	-	-	-	\$8.40	-	-	-	-
SCMT 32.51-ZM1	-	-	-	-	-	-	-	-	-	-	-	-	\$6.70	-	-	-
SCMT 32.52-ZM1	-	-	-	-	-	-	-	-	-	-	-	-	\$6.70	-	-	-
SCGX 32.50.5-ZN1	-	-	-	-	-	-	-	-	-	-	-	-	-	-	-	\$8.40
SCGX 32.51-ZN1	-	-	-	-	-	-	-	-	-	-	-	-	-	-	-	\$8.40
SCGX 32.52-ZN1	-	-	-	-	-	-	-	-	-	-	-	-	-	-	-	\$8.40
SCMT 32.51-ZX3	-	-	-	-	-	-	-	\$6.70	\$6.70	-	-	-	-	-	-	-
SCMT 32.52-ZX3	-	-	-	-	-	-	-	\$6.70	\$6.70	-	-	-	-	-	-	-
SCMT 431-ZX3	-	-	-	-	-	-	-	\$8.00	\$8.00	-	-	-	-	-	-	-
SCMT 432-ZX3	-	-	-	-	-	-	-	\$8.00	\$8.00	-	-	-	-	-	-	-
SCMW 21.51	-	-	-	-	-	-	-	\$6.20	\$6.70	\$6.70	\$4.90	\$6.20	-	-	-	-

Inserts sold in packs of 10



New Patriot Products

See New Cutters *pg:108*



New Patriot Drill Sizes

See New Drills *pg:122*

T

INSERTS

Turning Inserts



CX1



LX6



ZM1



ZN1



ZX3

DESIGNATION	GRADE															
	HP230	HP250	HM240	HM250	HS220	HN432	HK036	UD51	UD52	UD21	UD2	UD22	UD32	UD5C	UD5CT	UD1
TCMT 21.51-CX1	-	\$7.00	-	\$7.00	-	-	\$7.00	-	-	-	-	-	-	-	-	-
TCMT 21.52-CX1	-	\$7.00	-	\$7.00	-	-	\$7.00	-	-	-	-	-	-	-	-	-
TCMT 32.51-CX1	-	\$8.90	-	\$8.90	-	-	\$8.90	-	-	-	-	-	-	-	-	-
TCMT 32.52-CX1	-	\$8.90	-	\$8.90	-	-	\$8.90	-	-	-	-	-	-	-	-	-
TCMT 1.21.20.5-LX6	-	-	-	-	-	-	-	\$8.40	\$10.10	\$10.10	-	-	-	-	-	-
TCMT 21.51-ZM1	-	-	-	-	-	-	-	-	-	-	-	-	\$6.10	-	-	-
TCMT 32.51-ZM1	-	-	-	-	-	-	-	-	-	-	-	-	\$7.80	-	-	-
TCMT 32.52-ZM1	-	-	-	-	-	-	-	-	-	-	-	-	\$7.80	-	-	-
TCGX 21.50.5-ZN1	-	-	-	-	-	-	-	-	-	-	-	-	-	-	-	\$8.10
TCGX 21.51-ZN1	-	-	-	-	-	-	-	-	-	-	-	-	-	-	-	\$8.10
TCGX 21.52-ZN1	-	-	-	-	-	-	-	-	-	-	-	-	-	-	-	\$8.10
TCGX 32.51-ZN1	-	-	-	-	-	-	-	-	-	-	-	-	-	-	-	\$9.30
TCGX 32.52-ZN1	-	-	-	-	-	-	-	-	-	-	-	-	-	-	-	\$9.30
TCMT 21.51-ZX3	-	-	-	-	-	-	-	\$6.10	\$6.10	\$6.10	-	-	-	-	-	-
TCMT 21.52-ZX3	-	-	-	-	-	-	-	\$6.10	\$6.10	\$6.10	-	-	-	-	-	-
TCMT 32.51-ZX3	-	-	-	-	-	-	-	\$7.80	\$7.80	\$7.80	-	\$7.30	-	-	-	-
TCMT 32.52-ZX3	-	-	-	-	-	-	-	\$7.80	\$7.80	\$7.80	-	\$7.30	-	-	-	-

Inserts sold in packs of 10



LX6

DESIGNATION	GRADE															
	HP230	HP250	HM240	HM250	HS220	HN432	HK036	UD51	UD52	UD21	UD2	UD22	UD32	UD5C	UD5CT	UD1
TPMT 21.51-LX6	-	-	-	-	-	-	-	\$8.30	\$9.90	\$9.20	\$6.80	-	-	-	-	-
TPMT 21.52-LX6	-	-	-	-	-	-	-	\$8.30	\$9.90	\$9.20	\$6.80	-	-	-	-	-
TPMT 32.51-LX6	-	-	-	-	-	-	-	\$9.90	\$11.40	\$11.00	\$8.30	-	-	-	-	-
TPMT 32.52-LX6	-	-	-	-	-	-	-	\$9.90	\$11.40	\$11.00	\$8.30	-	-	-	-	-

Inserts sold in packs of 10

INSERTS

Turning Inserts



CP1



ZM1



ZX3

DESIGNATION	GRADE															
	HP230	HP250	HM240	HM250	HS220	HN432	HK036	UD51	UD52	UD21	UD2	UD22	UD32	UD5C	UD5CT	UD1
VBMT 331-CP1	-	\$12.00	-	-	-	-	-	-	-	-	-	-	-	-	-	-
VBMT 332-CP1	-	\$12.00	-	-	-	-	-	-	-	-	-	-	-	-	-	-
VBMT 331-ZM1	-	-	-	-	-	-	-	-	-	-	-	-	\$8.80	-	-	-
VBMT 332-ZM1	-	-	-	-	-	-	-	-	-	-	-	-	\$8.80	-	-	-
VBMT 21.50.5-ZX3	-	-	-	-	-	-	-	\$8.80	\$10.50	-	-	-	-	-	-	-
VBMT 21.51-ZX3	-	-	-	-	-	-	-	\$8.80	\$10.50	-	-	-	-	-	-	-
VBMT 331-ZX3	-	-	-	-	-	-	-	\$8.80	\$9.80	-	-	-	-	-	-	-
VBMT 332-ZX3	-	-	-	-	-	-	-	\$8.80	\$9.80	-	-	-	-	-	-	-

Inserts sold in packs of 10



CX1



LX6



ZX3

DESIGNATION	GRADE															
	HP230	HP250	HM240	HM250	HS220	HN432	HK036	UD51	UD52	UD21	UD2	UD22	UD32	UD5C	UD5CT	UD1
WCMT 21.51-CX1	-	\$7.30	-	\$7.30	-	-	-	-	-	-	-	-	-	-	-	-
WCMT 21.52-CX1	-	\$7.30	-	\$7.30	-	-	-	-	-	-	-	-	-	-	-	-
WCMT 32.51-CX1	-	\$8.60	-	\$8.60	-	-	-	-	-	-	-	-	-	-	-	-
WCMT 32.52-CX1	-	\$8.60	-	\$8.60	-	-	-	-	-	-	-	-	-	-	-	-
WCMT 21.51-LX6	-	-	-	-	-	-	-	\$9.50	\$10.10	\$11.00	\$7.40	-	-	-	-	-
WCMT 21.52-LX6	-	-	-	-	-	-	-	\$9.50	\$10.10	\$11.00	\$7.40	-	-	-	-	-
WCMT 32.51-LX6	-	-	-	-	-	-	-	\$11.00	\$13.00	\$12.00	\$9.60	-	-	-	-	-
WCMT 32.52-LX6	-	-	-	-	-	-	-	\$11.00	\$13.00	\$12.00	\$9.60	-	-	-	-	-
WCMT 1.210.5-ZX3	-	-	-	-	-	-	-	\$12.00	\$13.00	\$13.00	\$12.00	-	-	-	-	-
WCMT 1.211-ZX3	-	-	-	-	-	-	-	\$12.00	\$13.00	\$13.00	\$12.00	-	-	-	-	-
WCMT 1.51.50.5-ZX3	-	-	-	-	-	-	-	\$12.00	\$13.00	\$13.00	\$12.00	-	-	-	-	-
WCMT 1.51.51-ZX3	-	-	-	-	-	-	-	\$12.00	\$13.00	\$13.00	\$12.00	-	-	-	-	-

Inserts sold in packs of 10



Turning Inserts

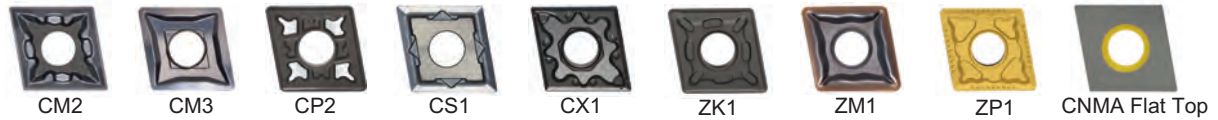

DESIGNATION	GRADE															
	HP230	HP250	HM240	HM250	HS220	HN432	HK036	UD51	UD52	UD21	UD2	UD22	UD32	UD5C	UD5CT	UD1
CNMG 321-CM2	-	-	-	\$8.00	-	-	-	-	-	-	-	-	-	-	-	-
CNMG 322-CM2	-	-	-	\$8.00	-	-	-	-	-	-	-	-	-	-	-	-
CNMG 431-CM2	-	-	-	\$9.80	-	-	-	-	-	-	-	-	-	-	-	-
CNMG 432-CM2	-	-	-	\$9.80	-	-	-	-	-	-	-	-	-	-	-	-
CNGP 431-CM3	-	-	\$18.00	-	-	-	-	-	-	-	-	-	-	-	-	-
CNGP 432-CM3	-	-	\$18.00	-	-	-	-	-	-	-	-	-	-	-	-	-
CNMG 543-CP2	-	\$18.00	-	-	-	-	-	-	-	-	-	-	-	-	-	-
CNMG 643-CP2	-	\$23.00	-	-	-	-	-	-	-	-	-	-	-	-	-	-
CNMG 431-CS1	-	-	-	-	\$9.80	-	-	-	-	-	-	-	-	-	-	-
CNMG 431-CX1	\$9.80	\$9.80	-	-	-	-	-	-	-	-	-	-	-	-	-	-
CNMG 432-CX1	\$9.80	\$9.80	-	-	-	-	\$9.80	-	-	-	-	-	-	-	-	-
CNMG 433-CX1	-	-	-	-	-	-	\$9.80	-	-	-	-	-	-	-	-	-
CNMG 321-ZK1	-	-	-	-	-	-	-	-	-	\$6.80	-	-	-	-	-	-
CNMG 322-ZK1	-	-	-	-	-	-	-	-	-	\$6.80	-	-	-	-	-	-
CNMG 431-ZK1	-	-	-	-	-	-	-	-	-	\$8.60	-	-	-	-	-	-
CNMG 432-ZK1	-	-	-	-	-	-	-	-	-	\$8.60	-	-	-	-	-	-
CNMG 542-ZK1	-	-	-	-	-	-	-	-	-	\$12.00	-	-	-	-	-	-
CNMG 543-ZK1	-	-	-	-	-	-	-	-	-	\$12.00	-	-	-	-	-	-
CNMG 642-ZK1	-	-	-	-	-	-	-	-	-	\$15.00	-	-	-	-	-	-
CNMG 643-ZK1	-	-	-	-	-	-	-	-	-	\$15.00	-	-	-	-	-	-
CNMG 321-ZM1	-	-	-	-	-	-	-	-	-	-	-	-	\$6.80	-	-	-
CNMG 322-ZM1	-	-	-	-	-	-	-	-	-	-	-	-	\$6.80	-	-	-
CNMG 431-ZM1	-	-	-	-	-	-	-	-	-	-	-	-	\$8.60	-	-	-
CNMG 432-ZM1	-	-	-	-	-	-	-	-	-	-	-	-	\$8.60	-	-	-
CNMG 321-ZP1	-	-	-	-	-	-	-	\$6.80	\$6.80	-	-	-	-	-	-	-
CNMG 322-ZP1	-	-	-	-	-	-	-	\$6.80	\$6.80	-	-	-	-	-	-	-
CNMG 431-ZP1	-	-	-	-	-	-	-	\$8.60	\$8.60	-	-	-	-	-	-	-
CNMG 432-ZP1	-	-	-	-	-	-	-	\$8.60	\$8.60	-	-	-	-	-	-	-
CNMG 542-ZP1	-	-	-	-	-	-	-	\$12.00	\$12.00	-	-	-	-	-	-	-
CNMG 543-ZP1	-	-	-	-	-	-	-	\$12.00	\$12.00	-	-	-	-	-	-	-
CNMG 642-ZP1	-	-	-	-	-	-	-	\$15.00	\$15.00	-	-	-	-	-	-	-
CNMG 643-ZP1	-	-	-	-	-	-	-	\$15.00	\$15.00	-	-	-	-	-	-	-
CNMA 432	-	-	-	-	-	-	\$9.80	-	-	-	-	-	-	-	-	-
CNMA 433	-	-	-	-	-	-	\$9.80	-	-	-	-	-	-	-	-	-
CNMA 543	-	-	-	-	-	-	\$16.00	-	-	-	-	-	-	-	-	-
CNMA 643	-	-	-	-	-	-	\$21.00	-	-	-	-	-	-	-	-	-

Inserts sold in packs of 10

Turning Inserts



DESIGNATION	GRADE															
	HP230	HP250	HM240	HM250	HS220	HN432	HK036	UD51	UD52	UD21	UD2	UD22	UD32	UD5C	UD5CT	UD1
DNMG 331-CM2	-	-	-	\$9.90	-	-	-	-	-	-	-	-	-	-	-	-
DNMG 332-CM2	-	-	-	\$9.90	-	-	-	-	-	-	-	-	-	-	-	-
DNMG 431-CM2	-	-	-	\$13.00	-	-	-	-	-	-	-	-	-	-	-	-
DNMG 432-CM2	-	-	-	\$13.00	-	-	-	-	-	-	-	-	-	-	-	-
DNGP 431-CM3	-	-	\$19.00	-	-	-	-	-	-	-	-	-	-	-	-	-
DNMG 331-CX1	-	\$9.90	-	-	-	-	-	-	-	-	-	-	-	-	-	-
DNMG 332-CX1	-	\$9.90	-	-	-	-	-	-	-	-	-	-	-	-	-	-
DNMG 431-CX1	-	\$13.00	-	-	-	-	-	-	-	-	-	-	-	-	-	-
DNMG 432-CX1	-	\$13.00	-	-	-	-	-	-	-	-	-	-	-	-	-	-
DNMG 542-LX2	-	-	-	-	-	-	-	\$15.00	\$16.00	\$15.00	-	-	-	-	-	-
DNMG 543-LX2	-	-	-	-	-	-	-	\$15.00	\$16.00	\$15.00	-	-	-	-	-	-
DNMG 331-ZM1	-	-	-	-	-	-	-	-	-	-	-	-	\$8.70	-	-	-
DNMG 332-ZM1	-	-	-	-	-	-	-	-	-	-	-	-	\$8.70	-	-	-
DNMG 431-ZM1	-	-	-	-	-	-	-	-	-	-	-	-	\$9.70	-	-	-
DNMG 432-ZM1	-	-	-	-	-	-	-	-	-	-	-	-	\$9.70	-	-	-
DNMG 331-ZP1	-	-	-	-	-	-	-	\$8.70	\$8.70	-	-	-	-	-	-	-
DNMG 332-ZP1	-	-	-	-	-	-	-	\$8.70	\$8.70	-	-	-	-	-	-	-
DNMG 431-ZP1	-	-	-	-	-	-	-	\$9.70	\$9.70	-	-	-	-	-	-	-
DNMG 432-ZP1	-	-	-	-	-	-	-	\$9.70	\$9.70	-	-	-	-	-	-	-
DNMG 331-ZX2	-	-	-	-	-	-	-	-	-	\$8.70	-	-	-	-	-	-
DNMG 332-ZX2	-	-	-	-	-	-	-	-	-	\$8.70	-	-	-	-	-	-
DNMG 431-ZX2	-	-	-	-	-	-	-	-	-	\$9.70	-	-	-	-	-	-
DNMG 432-ZX2	-	-	-	-	-	-	-	-	-	\$9.70	-	-	-	-	-	-
DNMA 431	-	-	-	-	-	-	\$15.00	-	-	-	-	-	-	-	-	-
DNMA 432	-	-	-	-	-	-	\$15.00	-	-	-	-	-	-	-	-	-

Inserts sold in packs of 10



LX2



RNMA Flat Top

DESIGNATION	GRADE															
	HP230	HP250	HM240	HM250	HS220	HN432	HK036	UD51	UD52	UD21	UD2	UD22	UD32	UD5C	UD5CT	UD1
RNMG 32-LX2	-	-	-	-	-	-	-	\$7.30	\$9.20	\$8.40	-	-	-	-	-	-
RNMG 43-LX2	-	-	-	-	-	-	-	\$8.90	\$11.00	\$9.80	-	-	-	-	-	-
RNMG 54-LX2	-	-	-	-	-	-	-	\$14.00	\$16.00	\$15.00	-	-	-	-	-	-
RNMG 64-LX2	-	-	-	-	-	-	-	\$18.00	\$19.00	\$18.00	-	-	-	-	-	-
RNMA 43	-	-	-	-	-	-	\$7.50	-	-	-	-	-	-	-	-	-

Inserts sold in packs of 10



INSERTS

Turning Inserts



DESIGNATION	GRADE															
	HP230	HP250	HM240	HM250	HS220	HN432	HK036	UD51	UD52	UD21	UD2	UD22	UD32	UD5C	UD5CT	UD1
SNMG 543-CP2	-	\$18.00	-	-	-	-	-	-	-	-	-	-	-	-	-	-
SNMG 643-CP2	-	\$23.00	-	-	-	-	-	-	-	-	-	-	-	-	-	-
SNMG 432-CS1	-	-	-	-	\$9.90	-	-	-	-	-	-	-	-	-	-	-
SNMG 432-CX1	-	\$9.90	-	-	-	-	\$9.90	-	-	-	-	-	-	-	-	-
SNMG 643-ZK1	-	-	-	-	-	-	-	-	-	\$15.00	-	-	-	-	-	-
SNMG 644-ZK1	-	-	-	-	-	-	-	-	-	\$15.00	-	-	-	-	-	-
SNMG 431-ZM1	-	-	-	-	-	-	-	-	-	-	-	-	\$7.30	-	-	-
SNMG 432-ZM1	-	-	-	-	-	-	-	-	-	-	-	-	\$7.30	-	-	-
SNMG 431-ZP1	-	-	-	-	-	-	-	\$7.30	\$7.30	-	-	-	-	-	-	-
SNMG 432-ZP1	-	-	-	-	-	-	-	\$7.30	\$7.30	-	-	-	-	-	-	-
SNMG 542-ZP1	-	-	-	-	-	-	-	\$12.00	\$12.00	-	-	-	-	-	-	-
SNMG 543-ZP1	-	-	-	-	-	-	-	\$12.00	\$12.00	-	-	-	-	-	-	-
SNMG 643-ZP1	-	-	-	-	-	-	-	\$15.00	\$15.00	-	-	-	-	-	-	-
SNMG 644-ZP1	-	-	-	-	-	-	-	\$15.00	\$15.00	-	-	-	-	-	-	-
SNMG 431-ZX2	-	-	-	-	-	-	-	-	-	\$7.30	-	-	-	-	-	-
SNMG 432-ZX2	-	-	-	-	-	-	-	-	-	\$7.30	-	-	-	-	-	-
SNMG 543-ZX2	-	-	-	-	-	-	-	-	-	\$12.00	-	-	-	-	-	-
SNMA 432	-	-	-	-	-	-	\$10.30	-	-	-	-	-	-	-	-	-
SNMA 543	-	-	-	-	-	-	\$14.00	-	-	-	-	-	-	-	-	-

Inserts sold in packs of 10



DESIGNATION	GRADE															
	HP230	HP250	HM240	HM250	HS220	HN432	HK036	UD51	UD52	UD21	UD2	UD22	UD32	UD5C	UD5CT	UD1
TNMG 331-CM2	-	-	-	\$9.10	-	-	-	-	-	-	-	-	-	-	-	-
TNMG 332-CM2	-	-	-	\$9.10	-	-	-	-	-	-	-	-	-	-	-	-
TNMG 332-CS1	-	-	-	-	\$9.10	-	-	-	-	-	-	-	-	-	-	-
TNMG 331-CX1	\$9.10	\$9.10	-	-	-	-	-	-	-	-	-	-	-	-	-	-
TNMG 332-CX1	\$9.10	\$9.10	-	-	-	-	\$9.10	-	-	-	-	-	-	-	-	-
TNMG 431-CX1	-	\$14.00	-	-	-	-	-	-	-	-	-	-	-	-	-	-
TNMG 432-CX1	-	\$14.00	-	-	-	-	\$14.00	-	-	-	-	-	-	-	-	-
TNMG 542-LX2	-	-	-	-	-	-	-	\$15.00	\$16.00	\$15.00	-	-	-	-	-	-
TNMG 543-LX2	-	-	-	-	-	-	-	\$15.00	\$16.00	\$15.00	-	-	-	-	-	-
TNMG 331-ZM1	-	-	-	-	-	-	-	-	-	-	-	-	\$7.10	-	-	-
TNMG 332-ZM1	-	-	-	-	-	-	-	-	-	-	-	-	\$7.10	-	-	-
TNMG 431-ZM1	-	-	-	-	-	-	-	-	-	-	-	-	\$9.10	-	-	-
TNMG 432-ZM1	-	-	-	-	-	-	-	-	-	-	-	-	\$9.10	-	-	-
TNMG 331-ZP1	-	-	-	-	-	-	-	\$7.10	\$7.10	-	-	-	-	-	-	-
TNMG 332-ZP1	-	-	-	-	-	-	-	\$7.10	\$7.10	-	-	-	-	-	-	-
TNMG 431-ZP1	-	-	-	-	-	-	-	\$9.10	\$9.10	-	-	-	-	-	-	-
TNMG 432-ZP1	-	-	-	-	-	-	-	\$9.10	\$9.10	-	-	-	-	-	-	-
TNMG 331-ZX2	-	-	-	-	-	-	-	-	-	\$7.10	-	-	-	-	-	-
TNMG 332-ZX2	-	-	-	-	-	-	-	-	-	\$7.10	-	-	-	-	-	-
TNMG 431-ZX2	-	-	-	-	-	-	-	-	-	\$14.00	-	-	-	-	-	-
TNMG 432-ZX2	-	-	-	-	-	-	-	-	-	\$14.00	-	-	-	-	-	-
TNMA 332	-	-	-	-	-	-	\$7.80	-	-	-	-	-	-	-	-	-
TNMA 432	-	-	-	-	-	-	\$12.00	-	-	-	-	-	-	-	-	-
TNMA 543	-	-	-	-	-	-	\$20.00	-	-	-	-	-	-	-	-	-

Inserts sold in packs of 10

INSERTS

Turning Inserts



DESIGNATION	GRADE															
	HP230	HP250	HM240	HM250	HS220	HN432	HK036	UD51	UD52	UD21	UD2	UD22	UD32	UD5C	UD5CT	UD1
VNMG 332-CM2	-	-	-	\$13.00	-	-	-	-	-	-	-	-	-	-	-	-
VNMG 332-CS1	-	-	-	-	\$13.00	-	-	-	-	-	-	-	-	-	-	-
VNMG 331-CX1	\$13.00	\$13.00	-	-	-	-	-	-	-	-	-	-	-	-	-	-
VNMG 332-CX1	\$13.00	\$13.00	-	-	-	-	-	-	-	-	-	-	-	-	-	-
VNMG 432-LX3	-	-	-	-	-	-	-	\$13.00	\$14.00	\$12.00	\$15.00	-	-	-	-	-
VNMG 331-ZM1	-	-	-	-	-	-	-	-	-	-	-	-	\$11.00	-	-	-
VNMG 332-ZM1	-	-	-	-	-	-	-	-	-	-	-	-	\$11.00	-	-	-
VNMG 331-ZX2	-	-	-	-	-	-	-	\$11.00	\$11.00	\$11.00	-	-	-	-	-	-
VNMG 332-ZX2	-	-	-	-	-	-	-	\$11.00	\$11.00	\$11.00	-	-	-	-	-	-
VNMA 332	-	-	-	-	-	-	\$15.00	-	-	-	-	-	-	-	-	-

Inserts sold in packs of 10



DESIGNATION	GRADE															
	HP230	HP250	HM240	HM250	HS220	HN432	HK036	UD51	UD52	UD21	UD2	UD22	UD32	UD5C	UD5CT	UD1
WNMG 432-CM2	-	-	-	\$10.60	-	-	-	-	-	-	-	-	-	-	-	-
WNMG 432-CS1	-	-	-	-	\$10.60	-	-	-	-	-	-	-	-	-	-	-
WNMG 331-CX1	\$9.10	\$9.10	-	-	-	-	-	-	-	-	-	-	-	-	-	-
WNMG 332-CX1	\$9.10	\$9.10	-	-	-	-	-	-	-	-	-	-	-	-	-	-
WNMG 431-CX1	\$10.60	\$10.60	-	-	-	-	-	-	-	-	-	-	-	-	-	-
WNMG 432-CX1	\$10.60	\$10.60	-	-	-	-	\$10.60	-	-	-	-	-	-	-	-	-
WNMG 433-CX1	-	-	-	-	-	-	\$10.60	-	-	-	-	-	-	-	-	-
WNMG 331-ZM1	-	-	-	-	-	-	-	-	-	-	-	-	\$6.40	-	-	-
WNMG 332-ZM1	-	-	-	-	-	-	-	-	-	-	-	-	\$6.40	-	-	-
WNMG 431-ZM1	-	-	-	-	-	-	-	-	-	-	-	-	\$8.30	-	-	-
WNMG 432-ZM1	-	-	-	-	-	-	-	-	-	-	-	-	\$8.30	-	-	-
WNMG 331-ZP1	-	-	-	-	-	-	-	\$6.40	\$6.40	-	-	-	-	-	-	-
WNMG 332-ZP1	-	-	-	-	-	-	-	\$6.40	\$6.40	-	-	-	-	-	-	-
WNMG 431-ZP1	-	-	-	-	-	-	-	\$8.30	\$8.30	-	-	-	-	-	-	-
WNMG 432-ZP1	-	-	-	-	-	-	-	\$8.30	\$8.30	-	-	-	-	-	-	-
WNMG 331-ZX2	-	-	-	-	-	-	-	-	-	\$6.40	-	-	-	-	-	-
WNMG 332-ZX2	-	-	-	-	-	-	-	-	-	\$6.40	-	-	-	-	-	-
WNMG 431-ZX2	-	-	-	-	-	-	-	-	-	\$8.30	-	-	-	-	-	-
WNMG 432-ZX2	-	-	-	-	-	-	-	-	-	\$8.30	-	-	-	-	-	-
WNMA 432	-	-	-	-	-	-	\$10.20	-	-	-	-	-	-	-	-	-

Inserts sold in packs of 10



INSERTS

CDE Inserts

CDE Inserts

- Used in facing, slotting, milling and other special applications.
- Side mounting design allows for more inserts per diameter vs conventional cutter bodies.

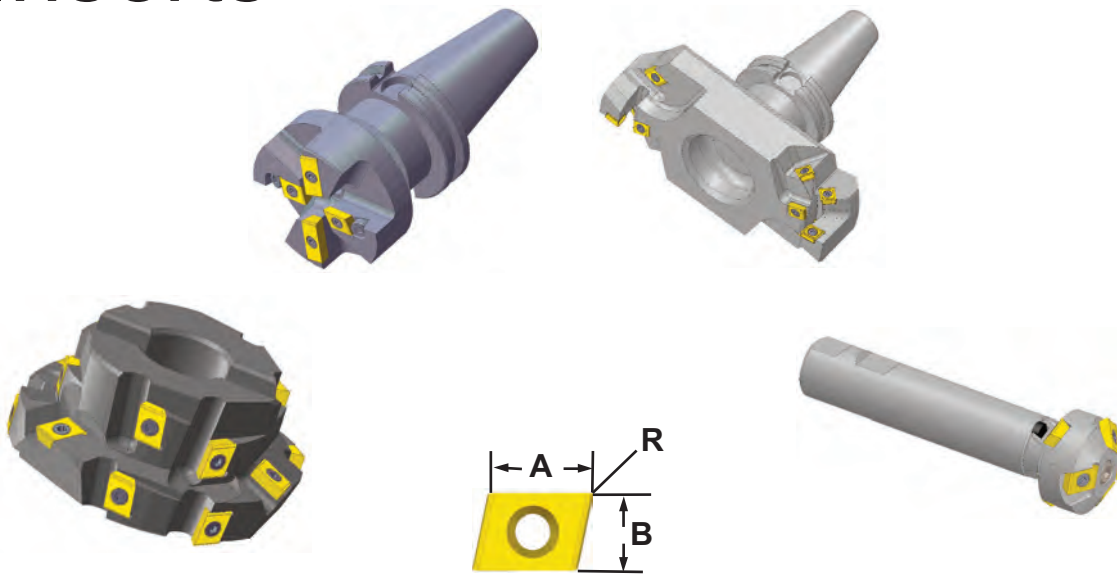

Designation	A	B	R	UD501	UD502	UD201	UD202	UD207	UD101
CDE-323R05	.500	.375	.031	\$15.80	\$14.76	\$14.18	\$15.64	\$15.60	\$15.80
CDE-323L05	.500	.375	.031	\$15.80	\$14.76	\$14.18	\$15.64	\$15.60	\$15.80
CDE-323R02	.500	.375	.015	-	-	-	\$15.42	\$16.35	-
CDE-323L02	.500	.375	.015	-	-	-	\$15.42	\$16.35	-
CDE-8X3L05	.500	.375	.031	\$19.86	\$20.55	-	\$20.44	\$25.12	\$33.86
CDE-8X3R05	.500	.375	.031	\$19.86	\$20.55	-	\$20.44	\$25.12	\$33.86

INSERTS

- Good
- ◐ Better
- Best

Grade	Description	Material Compatibility					
		Steel	Stainless Steel	Cast Iron	Ferrite Materials	Heat-Resistant Steel	Hardened Metal
		P	M	K	N	S	H
UD501	TIN Coated Steel Milling Grade	●	○	○		◐	
UD502	TIALN Coated Steel Milling Grade	●	○			●	
UD201	TIN Coated Cast Iron Grade		○	●			
UD202	TIALN Coated Cast Iron Grade.		○	●			
UD207	Supreme AlTiN Based Coated For High Wear Resistance		○	●		○	
UD101	Coated Milling Insert for machining Aluminum. Excellent when machining all non-Ferrous Material.				●		

Turning Inserts



SP2

Designation	UD51
WPGT 1.510-SP2	\$8.50
WPGT 1.510.5-SP2	\$8.50
WPGT 1.511-SP2	\$11.00
WPGT 21.50-SP2	\$8.40
WPGT 21.50.5-SP2	\$8.10
WPGT 21.51-SP2	\$11.00
WPMT 32.51-SP2	\$17.00
WPMT 32.52-SP2	\$17.00

Inserts sold in packs of 10

Series Style



SP1



Flat Top



SX1

Designation	UD51	UD25
TDHB 1.280.750.1	\$11.00	\$12.00
TDHB 1.280.750.5	\$13.00	\$11.00
TDHB 1.280.751	\$12.00	\$12.00
TPCB 220.5	\$11.00	\$11.00
TPCB 221	\$12.00	\$11.00
TPCB 222	\$11.00	\$12.00
TPCH 220.5-SP1	\$12.00	-
TPCH 221-SP1	\$12.00	-
TD 320.5	\$14.00	-
TD 321	\$14.00	-
TD 322	\$14.00	-
TPGH 321-SX1	\$18.00	\$15.00
TPGH 322-SX1	\$15.00	\$14.00

Inserts sold in packs of 10

Designation	UD5CBN	UD2CBN	UD2PCD
CCGW 21.51-1	\$45.00	\$45.00	\$64.00
CCGW 21.52-1	\$45.00	\$45.00	\$64.00
CCGW 32.51-2	\$69.00	\$69.00	\$67.00
CCGW 32.52-2	\$69.00	\$69.00	\$67.00
CNGA 431-2	\$69.00	\$69.00	-
CNGA 432-2	\$69.00	\$69.00	-
DCGW 21.51-1	\$45.00	\$45.00	\$65.00
DCGW 32.51-2	\$69.00	\$69.00	-
DCGW 32.52-2	\$69.00	\$69.00	-
DNGA 431-2	\$69.00	\$69.00	-
DNGA 432-2	\$69.00	\$69.00	-

Inserts sold individually

Designation	UD2PCD
CCGT 21.51-CB-1 *	\$96.00
CCGT 21.52-CB-1 *	\$96.00
CCGT 32.51-CB-1 *	\$98.00
CCGT 32.52-CB-1 *	\$107.00
DCGT 21.51-CB-1 *	\$101.00
DCGT 32.51-CB-1 *	\$107.00
DCGT 32.52-CB-1 *	\$119.00

Inserts sold individually

Designation	UD5CBN	UD2CBN	UD2PCD
TCGW 21.51-1	-	\$45.00	\$62.00
TCGW 21.52-1	\$45.00	\$45.00	\$62.00
TCGW 32.51-1	\$45.00	\$45.00	\$68.00
TCGW 32.52-1	\$45.00	\$45.00	\$68.00
TNGA 331-1	\$45.00	\$45.00	-
TNGA 332-1	\$45.00	\$45.00	-
VBGW 21.51-1	-	-	\$79.00
VBGW 21.52-1	-	-	\$79.00
VBGW 331-1	-	-	\$82.00
VBGW 332-1	-	-	\$94.00
VNGA 331-2	\$63.00	\$63.00	-
VNGA 332-2	\$63.00	\$63.00	-

Inserts sold individually

Designation	UD2PCD
TCGT 21.51-CB-1 *	\$101.00
TCGT 32.51-CB-1 *	\$105.00
TCGT 32.52-CB-1 *	\$117.00

Inserts sold individually

Designation	UD2PCD
VBGT 331-CB-1 *	\$142.00
VBGT 332-CB-1 *	\$156.00

Inserts sold individually

* Medium to Finish Machining

INSERTS

Patriot Drilling Inserts



High Performance

SEE PAGE 121
For All Available
Compatible Drills

SEE PAGE 124
For Speeds and Feeds



PD1

Designation	HP600	HK356	HN300
PD1 042004	\$9.10	\$9.10	\$16.70
PD1 052804	\$9.10	\$9.10	\$16.70
PD1 063306	\$9.30	\$9.30	\$17.00
PD1 074006	\$9.70	\$9.70	\$17.30
PD1 094508	\$11.00	\$11.00	\$18.00
PD1 125812	\$13.00	\$13.00	\$19.50
PD1 156812	\$14.00	\$14.00	\$21.70

Inserts sold in packs of 10

Drilling (ISO Standard)



Designation	UD51	UD52	UD2	UD21	UD32
WCMX 1.81.52	\$8.00	\$9.80	\$8.00	\$9.80	\$8.90
WCMX 21.52	\$8.00	\$9.80	\$8.00	\$9.80	\$8.90
WCMX 2.522	\$8.00	\$9.80	\$8.00	\$9.80	\$8.90
WCMX 32.52	\$8.70	\$10.50	\$8.70	\$10.50	\$9.70
WCMX 433	\$8.70	\$11.00	\$8.70	\$11.00	\$9.70

Inserts sold in packs of 10

F

INSERTS

Patriot Milling Inserts



SEE PAGES 107-110
For all Available
Compatible Mills



Designation	HP470	HM470	HS470	HS480	HK430	HN432
PM1 1205-HCX	\$21.00	-	-	-	-	-
PM1 1205-SCX	-	\$21.00	\$26.70	-	\$21.00	-

Inserts sold in packs of 10



Designation	HP470	HM470	HS470	HS480	HK430	HN432
PM2 09T308-HCX	\$12.00	-	-	-	-	-
PM2 09T308-SCX	-	\$12.00	\$19.00	\$19.00	-	-
PM2 09T308-CCX	-	-	-	-	\$12.00	-
PM2 09T308-LCX	-	-	-	-	-	\$14.00
PM2 120508-HCX	\$15.00	-	-	-	-	-
PM2 120508-SCX	-	\$15.00	\$23.00	\$23.00	-	-
PM2 120508-CCX	-	-	-	-	\$15.00	-

Inserts sold in packs of 10



Designation	HP470	HM470	HS470	HS480	HK430	HN432
PM3 10T308-HCX	\$12.00	-	-	-	\$12.00	-
PM3 10T308-SCX	-	\$12.00	\$15.00	\$17.00	-	-

Inserts sold in packs of 10



Designation	HP470	HM470	HS470	HS480	HK430	HN432
PM4 0604-HCX	\$14.00	-	-	-	\$14.00	-
PM4 0604-SCX	-	\$14.00	\$18.00	-	-	-
PM4 0604-LCX	-	-	-	-	-	\$20.00

Inserts sold in packs of 10



INSERTS

Milling Inserts

Milling (ISO Standard)



Designation	UD1	UD404	UD602
RDKW 0803	-	\$6.00	\$6.00
RCKT 10T3	\$5.70	\$5.70	\$5.70
RCKT 1204	\$6.80	\$6.80	\$6.80
RCKT 1606	-	\$9.90	\$9.90

Inserts sold in packs of 10



Designation	UD51	UD52	UD2	UD21	UD22
RCMT 21.5	\$8.50	\$9.80	\$7.00	\$9.20	\$7.80
RCMT 32.5	\$9.40	\$11.00	\$8.90	\$7.80	\$10.30
RCMT 43	\$11.00	\$13.00	\$9.00	\$12.00	\$10.50

Inserts sold in packs of 10



Designation	Radius	UD1	UD204	UD404	UD602
APKT 11T304-PF	.015	-	\$9.10	\$9.10	\$9.10
APKT 11T308-PF	.031	-	\$9.10	\$9.10	-
APKT 11T316-PF	.062	-	\$9.10	\$9.10	-
APKT 160408-PF	.031	-	-	\$11.00	\$11.00

Finish



APKT 11T304-PM	.015	-	\$9.10	\$9.10	\$9.10
APKT 11T308-PM	.031	-	\$9.10	\$9.10	\$9.10
APKT 11T312-PM	.046	-	-	\$9.10	-
APKT 11T316-PM	.062	-	\$9.10	\$9.10	-
APKT 160408-PM	.031	-	\$11.00	\$11.00	\$11.00

Semi-Rough



APKT 11T304-PR	.015	-	\$9.10	\$9.10	\$9.10
APKT 11T304-AL	.015	\$9.10	-	-	-
APKT 11T308-AL	.031	\$9.10	-	-	-
APKT 160408-AL	.031	\$11.00	-	-	-

Rough

Aluminum

Inserts sold in packs of 10

INSERTS

APKT 11T308



AP (inch)	Feed Per Tooth (inch)		
	Light	Medium	Heavy
.315	.0028	.0031	.0039
.236	.0039	.0047	.0059
.157	.0047	.0059	.0079

f/t

APKT 160408



AP (inch)	Feed Per Tooth (inch)		
	Light	Medium	Heavy
.472	.0028	.0031	.0039
.315	.0039	.0047	.0059
.197	.0047	.0059	.0079

f/t

Threading Inserts

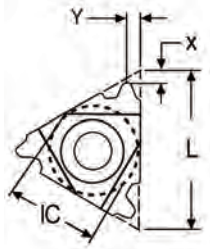

American Acme

Designation		I.C.	L	Pitch (tpi)	h (min)	X	Y	Anvil Right	Anvil Left	UD51
Right Hand	Left Hand									
3IR16ACME	3IL16ACME	3/8"	.630	16	.036	.040	.040	Y13	YE3	\$16.00
3IR14ACME	3IL14ACME	3/8"	.630	14	.041	.040	.050	Y13	YE3	\$16.00
3IR12ACME	3IL12ACME	3/8"	.630	12	.047	.050	.050	Y13	YE3	\$16.00
3IR10ACME	3IL10ACME	3/8"	.630	10	.060	.050	.050	Y13	YE3	\$16.00
3IR8ACME	3IL8ACME	3/8"	.630	8	.072	.060	.060	Y13	YE3	\$16.00

Inserts sold in packs of 10

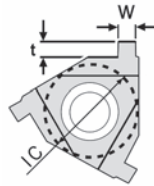

Grooving

Designation	I.C.	W	t	Anvil Right	UD51
Right Hand					
3IR NG W.031	3/8"	.031	.050	Y13M-1.5N	\$16.00
3IR NG W.047	3/8"	.047	.070	Y13M-1.5N	\$16.00
3IR NG W.062	3/8"	.062	.080	Y13M-1.5N	\$16.00
3IR NG W.093	3/8"	.093	.070	Y13	\$16.00

Inserts sold in packs of 10



NEW Boring Bars available
See Pg.24-25,32,40,62,65

NEW Square Shanks available
See Pg.8-9

F
INSERTS

Threading Inserts

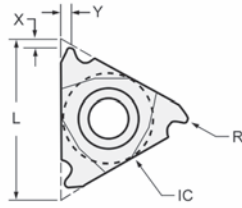

Partial Profile 60°

Designation		I.C.	L	Pitch (mm)	Pitch (tpi)	r	X	Y	Anvil Right	Anvil Left	UD51
Right Hand	Left Hand										
2JIRA60	2JILA60	1/4"	.630	.7-1.5	36-18	.004	.040	.045	YI3	YE3	\$11.00
2JIR12UN	2JIL12UN	1/4"	.630	1.0-2.0	28-12	.004	.030	.035	YI3	YE3	\$11.00
3IRA60	3ILA60	3/8"	.630	.05-1.5	48-16	.002	.030	.040	YI3	YE3	\$15.00
3IRG60	3ILG60	3/8"	.630	1.75-3.0	14-8	.006	.050	.070	YI3	YE3	\$15.00
3IRAG60	3ILAG60	3/8"	.630	.05-3.0	48-8	.002	.050	.070	YI3	YE3	\$15.00
3JIRA60	-	3/8" SCB	.630	.05-1.5	48-16	.002	.020	.030	YI3	-	\$15.00
3JIRG60	-	3/8" SCB	.630	1.75-3.0	14-8	.006	.040	.060	YI3	-	\$15.00
3JIRAG60	-	3/8" SCB	.630	.05-3.0	48-8	.002	.040	.060	YI3	-	\$15.00

Inserts sold in packs of 10

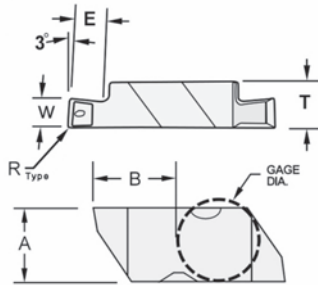

Top Notch Grooving

Designation		A	B	E	R	T	W	UD51
Right Hand	Left Hand							
NG-2R W.031	NG-2L W.031	.219	.270	.050	.002 / .005	.150	.031	\$25.00
NG-2R W.062	NG-2L W.062	.219	.270	.110	.005 / .010	.150	.062	\$25.00
NG-2R W.094	NG-2L W.094	.219	.270	.110	.005 / .010	.150	.094	\$25.00
NG-3R W.062	NG-3L W.062	.344	.405	.120	.005 / .010	.195	.062	\$25.00
NG-3R W.094	NG-3L W.094	.344	.405	.180	.005 / .010	.195	.094	\$25.00
NG-3R W.125	NG-3L W.125	.344	.405	.180	.005 / .010	.195	.125	\$25.00
NG-4R W.125	NG-4L W.125	.453	.636	.250	.005 / .010	.255	.125	\$36.00
NG-4R W.189	NG-4L W.189	.453	.636	.250	.020 / .025	.255	.189	\$36.00
NG-4R W.250	NG-4L W.250	.453	.636	.250	.020 / .025	.255	.250	\$36.00
NG-6R W.281	NG-6L W.281	.453	.636	.250	.030 / .035	.383	.281	\$39.00
NG-6R W.375	NG-6L W.375	.453	.636	.250	.030 / .035	.383	.375	\$39.00

Inserts sold individually

INSERTS

Threading Inserts

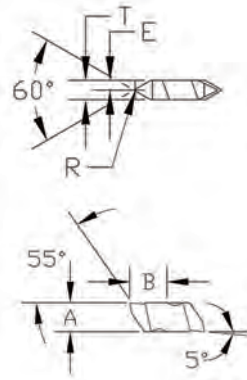

Top Notch Threading

Designation		A	B	E	R	T	Ext. TPI	Int. TPI	UD51
Right Hand	Left Hand								
NTP-2R	NTP-2L	.219	.266	.075	.003/.005	.150	8-36	1-20	\$21.00
NTP-3R	NTP-3L	.344	.400	.098	.005/.008	.195	6-20	5-12	\$22.00
NTP-4R	NTP-4L	.453	.629	.128	.005/.008	.255	4-20	4-12	\$29.00

Inserts sold individually

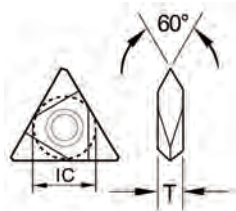

On Edge

Designation	I.C.	T	Radius	TPI	UD51
Right Hand					
TNMA-43NV	.500	.187	.003/.005	5-24	\$23.00
TNMA-43NV .010	.500	.187	.001	4-20	\$26.00
TNMC-43NV	.500	.187	.003/.005	5-24	\$23.00
TNMC-43NV .010	.500	.187	.001	4-20	\$26.00

Inserts sold individually

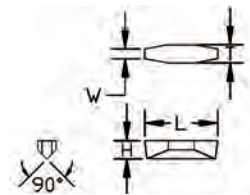

V-Bottom

Designation	T	L	Radius	TPI	UD51
Right Hand					
V84-NV	.250	1.000	.006/.008	5-20	\$24.00
V84-NV-.010R	.250	1.000	.010	4-20	\$26.00
V84-NV-.020R	.250	1.000	.020	4-12	\$26.00
V84-NV-.025R	.250	1.000	.025	4-8	\$26.00
V84-NV-.038R	.250	1.000	.038	4-6	\$26.00
V85-NV	.312	1.000	.006/.008	5-20	\$26.00

Inserts sold individually

T

INSERTS



Hardware

Boring Bars

Shim Seat	Price Each	Insert Screws	Price Each	Key	Price Each	Clamp	Price Each	Lock Pin	Price Each	Clamp Screw	Price Each
ICSN-433	\$4.80	MTS-183	\$2.60	T-6	\$3.40	CL-6	\$4.30	NL-33	\$2.40	XNS-36	\$1.80
ICSN-533	\$5.80	MTS-184	\$2.60	T-7	\$3.10	CL-7	\$4.30	NL-33L	\$2.40	XNS-47	\$1.80
ICSN-633	\$6.70	MTS-2	\$2.30	T-10	\$5.30	CL-9	\$4.30	NL-34	\$2.40	XNS-48	\$1.80
ISSN-432	\$4.70	MTS-224	\$2.60	T-15	\$3.10	CL-12	\$4.30	NL-34L	\$2.40	XNS-510	\$1.80
ISSN-433	\$4.70	MTS-255	\$2.60	T-20	\$3.20	CL-19	\$5.40	NL-44	\$2.40	XNS-58	\$1.80
ISSN-533	\$5.50	MTS-35	\$2.60	sold in QTY 5		CL-20	\$4.30	NL-46	\$2.20	XNS-59	\$1.80
ISSN-633	\$6.60	MTS-2.5L	\$2.30			CL-21	\$10.10	NL-56	\$2.70	sold in QTY 5	
IDSN-322	\$3.80	ETS 4-40	\$2.60			CL-22	\$10.60	NL-58	\$2.40		
IDSN-433	\$4.30	sold in QTY 5				CL-30	\$7.60	NL-68	\$2.70		
IDSN-533	\$6.60					CL-84	\$24.00	NL-68L	\$5.30		
ITSN-323	\$3.30	MTS-3.5L	\$7.00			CL-85	\$24.00	sold in QTY 5			
ITSN-433	\$5.30	MTS-4	\$8.20								
ITSN-533	\$6.90	MTS-526	\$9.40								
ITSN-636	\$9.30	sold in QTY 1									
IVSN-322	\$3.80										
IVSN-432	\$5.10										
IVSN-433	\$5.10										
IWSN-322	\$4.30										
IWSN-433	\$5.90										
IRSN-32	\$4.20										
IRSN-43	\$3.80										
IRSN-53	\$6.10										
IRSN-63	\$6.90										
sold in QTY 10											

Laydown Threaders

Anvil Screw	Price Each	Insert Screw	Price Each
SY3T	\$1.90	SA3T	\$2.80
SY4T	\$2.40	SA4T	\$3.80
SY5T	\$3.80	SA5T	\$6.60
sold in QTY 5			

Anvil	Price Each
YI3	\$17.00
YE3	\$17.00
YI4	\$29.00
YI3M-1.5N	\$28.00
YE4	\$29.00
YI5	\$46.00
YE5	\$46.00
sold in QTY 1	

Top Notch

Clamp	Price Each
CM-72	\$10.10
CM-73	\$10.10
CM-74	\$16.00
CM-75	\$16.00
CM-120	\$14.00
CM-121	\$14.00
CM-146	\$42.00
CM-147	\$42.00
sold in QTY 1	

Clamp Screw	Price Each
6-32	\$0.80
10-32	\$0.80
MTS-526	\$9.40
sold in QTY 5	

Pullback

Shim Screw	Price Each
PB3-SS	\$2.50
PB4-SS	\$2.50
sold in QTY 5	
Clamp Assy.	Price Each
PB3-CA	\$17.00
PB4-CA	\$18.00
sold in QTY 1	

Chatter-Free

Head Bolts	Price Each
8-32 HB	\$1.80
10-24 HB	\$1.80
1/4-20 HB	\$2.10
5/16-18 HB	\$2.40
sold in QTY 1	

Modular

Set Screws	Price Each
MH12S	\$1.40
MH16S	\$1.70
MH20S	\$2.00
MH24S	\$2.30
MH28S	\$2.60
MH32S	\$2.90
sold in QTY 2	

Drilling

Wrench	Price Each
T-6-S	\$4.30
T-7-S	\$4.20
T-8-S	\$4.30
T-9-S	\$4.90
T-10-S	\$4.90
T-15-S	\$4.90
T-25-S	\$8.80
sold in QTY 1	

Insert Screw	Price Each
MTS-184	\$2.60
MTS-2	\$2.30
MTS-255	\$2.60
MTS 25-DR	\$2.30
MTS 3-DR	\$2.30
MTS 35-DR	\$2.80
MTS 4-DR	\$2.30
sold in QTY 5	

Insert Screw	Price Each
PD1-16	\$4.90
PD1-2	\$4.40
PD1-22	\$4.40
PD1-25	\$4.40
PD1-35	\$4.40
PD1-5	\$5.20
PD1-6	\$7.40
sold in QTY 5	



Hardware

End Mill Holders

Set Screws	Price Each
SS10-250	\$2.70
SS1/4-250	\$2.70
SS3/8-375	\$2.70
SS7/16-500	\$4.30
SS9/16-500	\$8.30
SS5/8-500	\$8.30
SS3/4-375	\$9.20
SS3/4-500	\$9.20
SS1-750	\$9.70

sold in QTY 5

Shell Mill Holders

Arbor Screws	Price Each
U5001	\$9.00
U5002	\$9.60
U5003	\$12.00
U5004	\$16.00
U5005	\$23.00
U5006	\$29.00
U5007	\$40.00
AS1/4-100	\$1.40
AS3/8-125	\$1.40
AS1/2-150	\$2.70

sold in QTY 1

ER Collet Chuck Holders

Nut	Price Each
ER-11HN	\$19.00
ER-16HN	\$20.00
ER-20HN	\$23.00
ER-25SN	\$26.00
ER-32SN	\$29.00
ER-40SN	\$34.00
ER-11MN	\$21.00
ER-16MN	\$22.00
ER-20MN	\$24.00

sold in QTY 1

Adj. Screw	Price Each
ER-11S	\$6.70
ER-16S	\$7.10
ER-20S	\$7.90
ER-25S	\$9.30
ER-32S	\$10.10
ER-40S	\$12.00

sold in QTY 1

Wrench	Price Each
ER-11MW	\$36.00
ER-16MW	\$36.00
ER-16W	\$13.00
ER-20MW	\$40.00
ER-20W	\$13.00
ER-25W	\$15.00
ER-32W	\$17.00
ER-40W	\$24.00

sold in QTY 1

Milling

Insert Screw	Price Each
SR34505	\$2.30
SR14544	\$2.30
SR34505L	\$2.60

sold in QTY 5

Insert Screw	Price Each
PM1-4	\$3.50
PM2-3	\$3.50
PM2-4	\$4.20
PM3-35	\$3.50
PM4-4	\$4.20

sold in QTY 5



New Patriot Products

See New Cutters pg:108



New Patriot Drill Sizes

See New Drills pg:122



Repair Services

QUICK PIC QUOTING



SAVE up to 75% OFF the cost of new tooling!

- Full line of in-stock hardware
- Capable of repairing ANY manufacturer and insert type
- Experienced with HSK, KM, CAPTO, and all standard machine tapers
- All tools are brought back to original manufacturers specifications
- 4 week standard, Same day rush service available

**Save Time & Money
Involved with Shipping**

Simply take a pic of your damaged tool...

- Include your Name and Contact Information
- Reference your Distributor

EMAIL as attachment: repairs@ultra-dex.com (or) **Text:** 989-233-6482

Detail Work



We Can
Machine Anything

Custom Design & Build / Services

Custom Design & Build

Let us finish your vision...

in bringing your napkin sketches to real working tools

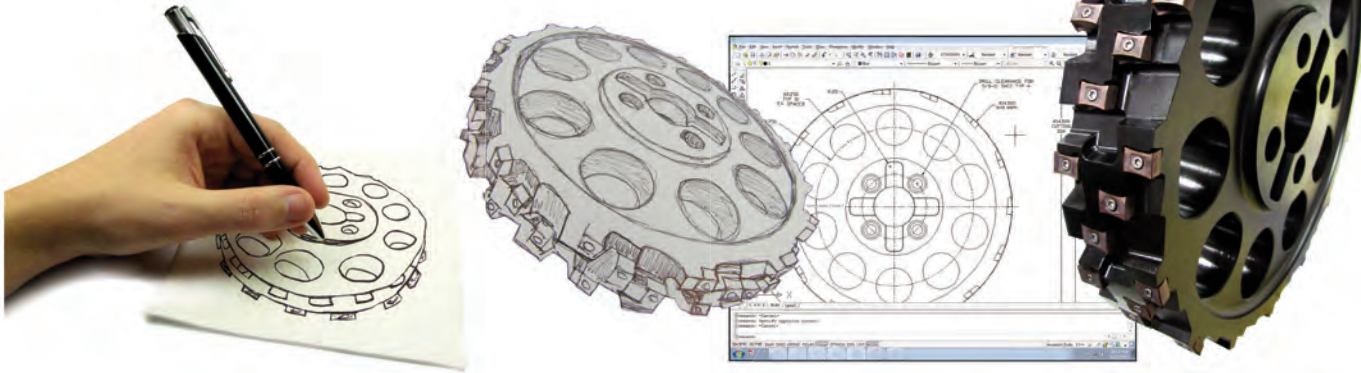

Bring Your Ideas to Reality!

Our experienced engineering staff allows us to design specialized tooling to perform multiple operations



- Milling Cutters
- Cartridges
- Trepan Tools
- Form Inserts & Blades
- Drill & Counter Bore Tools
- Chuck Jaws
- Tool Holders
- Boring Bars
- Multi-Diameter Boring Tools
- Broaching Tools
- Collets
- Modifications of Standard Tools

Our attention to cost effective machining saves you time & money

+ we maintain all necessary equipment for completing all of your manufacturing needs

+ More! SPECIALIZING IN Indexable Tooling

With Over 28 Years of experience in the design & build, and repair of indexable tooling, we offer the following quality manufacturing services:



Complete Grinding Department:
CNC, OD, ID, AD Surface Grinding + Jig and Centerless Grinding



Complete Lathe Department:
A full line of CNC Turning Centers + Manual Engine Lathes



Complete Milling Department:
A full line of CNC Machining Centers + Manual Knee Mills with Prototrak Controllers



Complete Wire EDM Department:
We offer the newest technology with our wire EDM Services specializing in Solid Carbide Form Inserts

Ordering / Shipping / Returns

Order By:



8am - 6pm (EST)
Monday - Thursday

8am - 5pm (EST)
Friday

(810) 638-5388



24 hours a day, every day

(810) 638-4001



24 hours a day, every day

sales@ultradexusa.com



In-Stock Items are Shipped **SAME DAY** if order is placed before **3:00pm EST**

Terms: Net 30 Days from the date of invoice.

Note: Prices in the catalog are subject to change without notice.

Any photographic and/or typographic error(s) in this catalog are subject to correction.

ULTRA-DEX

7144 Sheridan Rd • Flushing, MI 48433

Call: 810-638-5388 • Fax: 810-638-4001

sales@ULTRADEXUSA.COM

COMMITTED TO:

- Highest Quality
- Lowest Price
- Best Service
- USA Made

Distributed By: